



IABU Headquarters

Delta Electronics, Inc.
Taoyuan Technology Center
No.18, Xinglong Rd., Taoyuan City,
Taoyuan County 33068, Taiwan
TEL: 886-3-362-6301 / FAX: 886-3-371-6301

Asia

Delta Electronics (Jiangsu) Ltd.
Wujiang Plant 3
1688 Jiangxing East Road,
Wujiang Economic Development Zone
Wujiang City, Jiang Su Province,
People's Republic of China (Post code: 215200)
TEL: 86-512-6340-3008 / FAX: 86-769-6340-7290

Delta Greentech (China) Co., Ltd.
238 Min-Xia Road, Pudong District,
Shanghai, P.R.C.
Post code : 201209
TEL: 86-21-58635678 / FAX: 86-21-58630003

Delta Electronics (Japan), Inc.
Tokyo Office
2-1-14 Minato-ku Shibadaimon,
Tokyo 105-0012, Japan
TEL: 81-3-5733-1111 / FAX: 81-3-5733-1211

Delta Electronics (Korea), Inc.
1511, Byucksan Digital Valley 6-cha, Gasan-dong,
Geumcheon-gu, Seoul, Korea, 153-704
TEL: 82-2-515-5303 / FAX: 82-2-515-5302

Delta Electronics Int'l (S) Pte Ltd
4 Kaki Bukit Ave 1, #05-05, Singapore 417939
TEL: 65-6747-5155 / FAX: 65-6744-9228

Delta Electronics (India) Pvt. Ltd.
Plot No 43 Sector 35, HSIIDC
Gurgaon, PIN 122001, Haryana, India
TEL : 91-124-4874900 / FAX : 91-124-4874945

Americas

Delta Products Corporation (USA)
Raleigh Office
P.O. Box 12173, 5101 Davis Drive,
Research Triangle Park, NC 27709, U.S.A.
TEL: 1-919-767-3800 / FAX: 1-919-767-8080

Delta Greentech (Brasil) S.A
Sao Paulo Office
Rua Itapeva, 26 - 3º andar Edifício Itapeva One-Bela Vista
01332-000-São Paulo-SP-Brazil
TEL: +55 11 3568-3855 / FAX: +55 11 3568-3865

Europe

Deltronics (The Netherlands) B.V.
Eindhoven Office
De Witbogt 15, 5652 AG Eindhoven, The Netherlands
TEL: 31-40-2592850 / FAX: 31-40-2592851

*We reserve the right to change the information in this catalogue without prior notice.

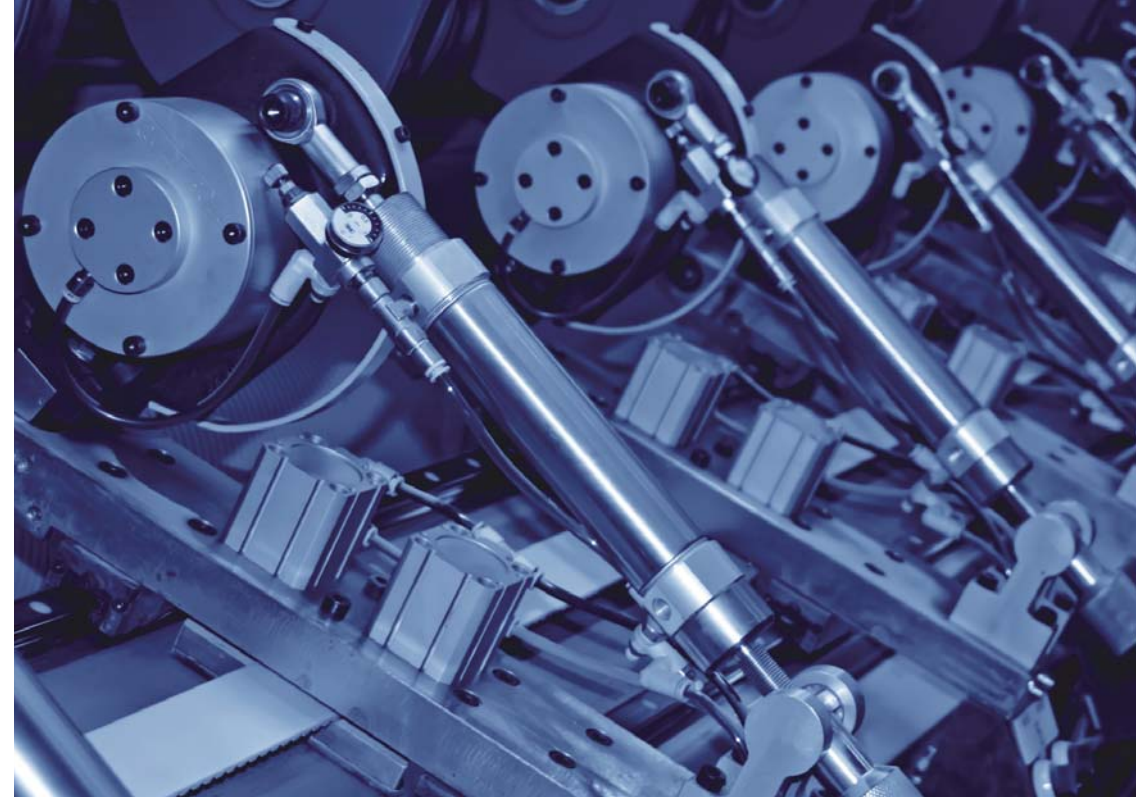

Automation for a Changing World

Delta AC Servo System ASDA-B2 Series



High Precision. High Response. Cost Effective.

Delta Electronics' new high-performance, cost-effective ASDA-B2 series servo motors and drives meet the requirements for general-purpose machine tools and enhance the competitive advantage of servo systems.

The power rating of the ASDA-B2 series ranges from 0.1kW to 3kW. The superior features of this series emphasize built-in generic functions for general purpose applications and avoiding variable costs from mechatronics integration. Delta's ASDA-B2 makes it convenient to complete assembly, wiring and operation setups. Switching from other brands is quick and easy due to the ASDA-B2's outstanding quality and features, and complete product lineup. The ASDA-B2 satisfies the requirements of general-purpose machine tools.

Customized solutions for different industries are available on request which is why the ASDA-B2 is popular and always in demand by customers in the field of industrial automation.



Transportation Machine

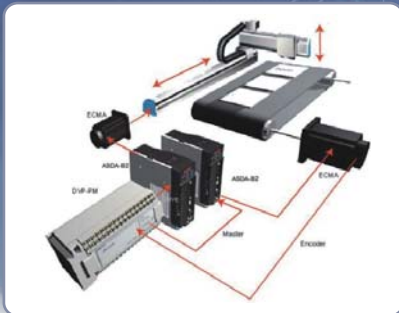

Electro-discharge Machine

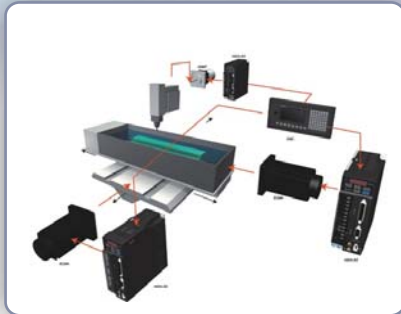

Cutting Machine

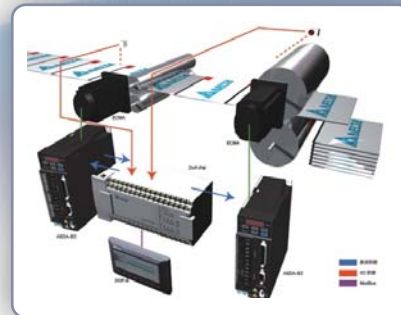

Sawing Machine



Contents

	Page
Features	3
Model Explanation	5
Product Line-up	6
Part Names and Functions	7
Standard Connection Examples	9
Regenerative Resistor	12
Safety Information	12
Specifications	13
Dimensions	15
ECMA Series Servo Motors(Specifications)	17
Dimensions	19
Speed-Torque Curve (T-N Curves)	19
Optional Accessories	23
Servo Drive, Servo Motor and Accessories Combinations	29

Features

Implements High Precision Positioning Control

- High-resolution encoder with 17-bit (160,000 p/rev) is a standard feature which satisfies the application needs of high precision positioning control and stable rotation at low speed.
- New 17-bit resolution encoder can reduce cogging torque to enhance the precision of the motor.

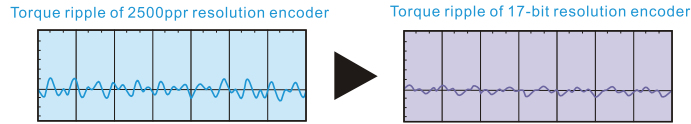

- Outstanding response characteristic: Up to 550kHz frequency response and settling time is below 1ms.
- 10ms acceleration time from -3000r/min to 3000r/min when running without load.

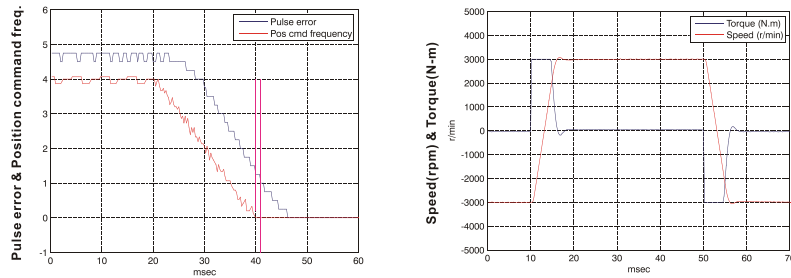

This example is frame size 60mm, 400W servo motor

Satisfies a Variety of Demands in the Industry

- Built-in position, speed and torque three control modes (speed and torque mode can be controlled via internal parameters or analog voltage command).
- High-speed line receiver command (4Mpps) is acceptable for high precision positioning control.
- Two auto notch filters are provided to suppress the mechanical resonance automatically and make the system operate more smoothly.
- Lead friction compensation parameter is specified for the application of circular interpolation, Z-axis motion and ball screw, etc. so as to reduce the loading of the controller.
- For bar feeders and other equipment requiring high torque output, motor protection parameters are offered to ensure that the mechanical system is not easily damaged.

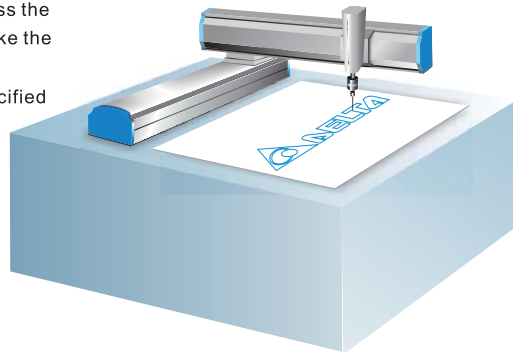

Offers Easy-To-Install Solution For Simple Start-Up



Power of control circuit and main power circuit is separated.

- Existing power cables and encoder cables can still be used for the ASDA series. When upgrading, there is no need to purchase new accessories.
- Servo motor provides brake, oil seal, etc. optional configurations for the requirements of different applications.
- The control circuit and main power circuit is separated, safety is increased and maintenance is much easier.
- 400W and above servo drive is built-in with regenerative resistor, for significant savings on wiring and cost.

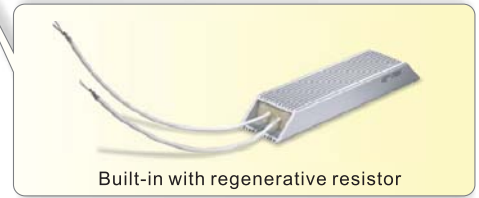

Built-in with regenerative resistor

Fulfills Easy-To-Use Requirements For Versatile Operation

- Motor sizing software is offered for convenient estimation of equipment.
- ASDA-Soft configuration software (tuning software) is provided to meet performance requirements quickly.
- Easy-to-use digital keypad is ideal for setting parameters and monitoring the servo drive and motor directly.
- Specific software communication cable ASD-CNUS0A08(Optional) for direct connection to PC increases communication quality and convenience of operation. (please refer to optional accessories on catalogue page 24)

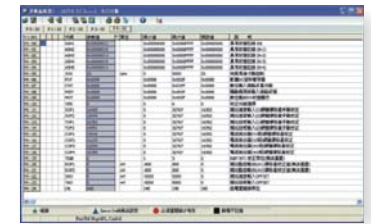
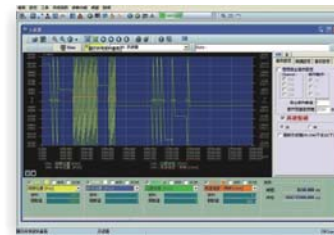

- 4 channels on-line monitoring function (similar to a digital oscilloscope) is available. The monitoring data could be 16-bit (4 channels) and 32-bit (2 channels) data.
- Multi-functional parameter editor function helps the users to edit, modify, upload / download and print desired parameters in real-time.

Model Explanation

ASDA-B2 Series Servo Drives

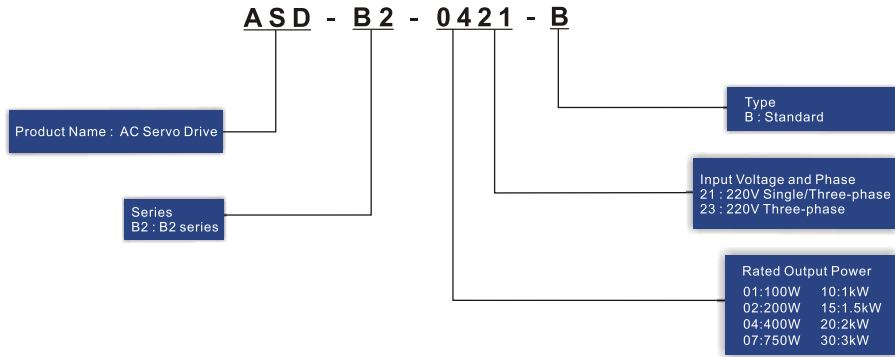

ECMA Series Servo Motors

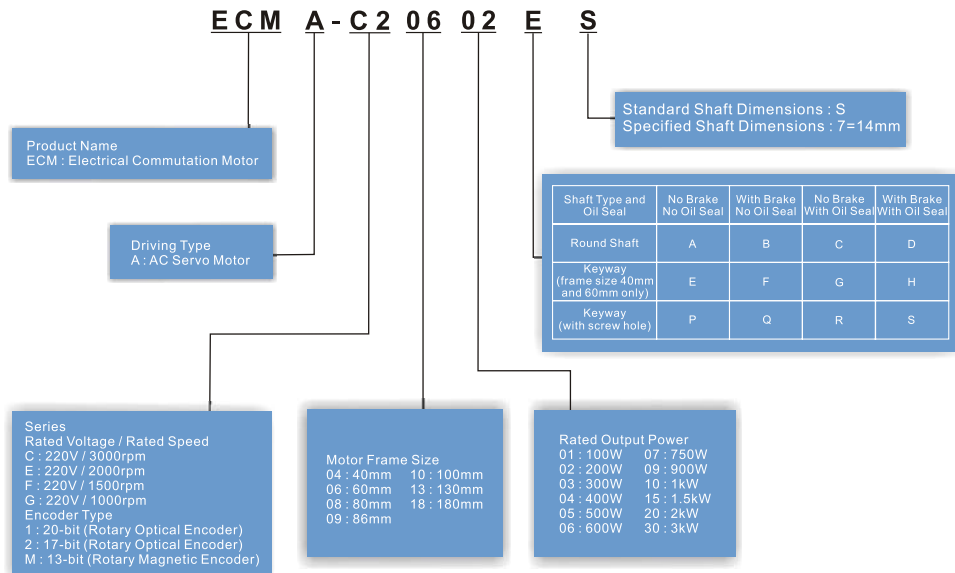

Product Line-up

Servo Drive								
	0.1kW	0.2kW	0.4kW	0.75kW	1.0kW	1.5kW	2kW	3kW
	ASD-B2-0121-B	ASD-B2-0221-B	ASD-B2-0421-B	ASD-B2-0721-B	ASD-B2-1021-B	ASD-B2-1521-B	ASD-B2-2023-B	ASD-B2-3023-B

Servo Motor								
	ECMA-CΔ0401□S	ECMA-CΔ0602□S	ECMA-CΔ0604□S ECMA-CM0604PS ECMA-CΔ0804□7	ECMA-GΔ1306□S ECMA-GM1306PS	ECMA-EΔ1310□S ECMA-GΔ1309□S ECMA-GM1309PS	ECMA-EΔ1315□S	ECMA-EΔ1320□S ECMA-EΔ1820□S	ECMA-FΔ1830□S
			ECMA-EΔ1305□S ECMA-GΔ1303□S	ECMA-CΔ0907□S	ECMA-CΔ0910□S			

Note:
 1. (□) in the model names are for optional configurations (keyway, brake and oil seal).
 2. (Δ) in the model names are for encoder resolution types (Δ=1: Incremental encoder, 20-bit; Δ=2: Incremental encoder, 17-bit).

Part Names and Functions

LED Display

- The 5 digit, 7 segment LED displays the servo status or fault codes.

Charge LED

- A lit LED indicates that either power is connected to the servo drive or a residual charge is present in the drive's internal power components.

Operation Panel

- Function keys used to perform status display, monitor and diagnostic, function and parameter setting. Function Keys:
 MODE : Press this key to select/change mode
 SHIFT : Press this key to shift cursor to the left
 ▲ : Press this key to increase values on the display
 ▼ : Press this key to decrease values on the display
 SET : Press this key to store data

Control Circuit Terminal (L1c, L2c)

- Used to connect 100~230Vac, 50/60Hz single-phase or three-phase VAC supply.

Main Circuit Terminal (R, S, T)

- Used to connect 200~230Vac, 50/60Hz commercial power supply.

Servo Motor Output (U, V, W)

- Used to connect servo motor. Never connect the output terminal to main circuit power as the AC drive may be damaged beyond repair if incorrect cables are connected to the output terminals.

Internal & External Regenerative Resistor Terminal

1. When using an external resistor, connect it to PA and C, and ensure an open circuit between PA and D.
2. When using an internal resistor, ensure the circuit is closed between PA and D, and the circuit is open between PA and C.
3. When using external braking unit, connect braking unit to PA and ⊖, and ensure an open circuit between PA and D, and PA and C.

Ground Terminal

- Used to connect grounding wire of power supply and servo motor.



I/O Interface

- Used to connect Delta's DVP series PLC or other external controllers for controlling I/O signals.

Motor Encoder Interface

- Used to connect the encoder of the servo motor

Serial Communication Port

- Used to connect PLC, HMI, etc. controllers for RS-485 / RS-232 serial communication.

Analog Voltage Output Terminal

- Used to provide two analog monitor outputs, MON1 and MON2.

Heatsink

- Used to secure servo drive and for heat dissipation.



Standard Connection Examples

Position (Pt) Control Mode (for Pulse Command Input)

Pulse input, for the use of internal power supply (Open-collector input)

Pulse input, for the use of external power supply (Open-collector input)

Pulse input (Line driver)

Caution: Because this photocoupler is a unidirectional photocoupler, please pay close attention on the current direction of input pulse command.

High-speed pulse input (Line receiver)

Caution: Ensure that the ground terminal of the controller and the servo drive are connected to each other.

4	T+	Blue
5	T-	Blue/Black
Reserved	-	-
Reserved	-	-
8	+5V	Red & Red/White
6.7	GND	Black & Black/White

6	RS485-
5	RS485+
4	RS232_RX
3	-
2	RS232_TX
1	GND

1	MON1
2	GND
3	MON2

Use a relay or open-collector transistor to input signal

NPN transistor with multiple emitter fingers (SINK Mode)

Wiring of DI signal, for the use of internal power supply

Wiring of DI signal, for the use of external power supply, inductive load

PNP transistor with multiple emitter fingers (SOURCE Mode)

Wiring of DI signal, for the use of internal power supply

Wiring of DI signal, for the use of external power supply

NOTE:

- *1. 400W and below drives do not provide built-in regenerative resistor.
- *2. The brake coil has no polarity.
- *3. Please refer to SINK / SOURCE modes

Speed (S) Control Mode

4	T+	Blue
5	T-	Blue/Black
Reserved	-	-
Reserved	-	-
8	+5V	Red & Red/White
6.7	GND	Black & Black/White

6	RS485-
5	RS485+
4	RS232_RX
3	-
2	RS232_TX
1	GND

1	MON1
2	GND
3	MON2

Use a relay or open-collector transistor to input signal

NPN transistor with multiple emitter fingers (SINK Mode)

Wiring of DI signal, for the use of internal power supply

Wiring of DI signal, for the use of external power supply, inductive load

PNP transistor with multiple emitter fingers (SOURCE Mode)

Wiring of DI signal, for the use of internal power supply

Wiring of DI signal, for the use of external power supply

NOTE:

- *1. 400W and below drives do not provide built-in regenerative resistor.
- *2. The brake coil has no polarity.
- *3. Please refer to SINK / SOURCE modes

Caution: Do not use dual power supply. Failure to observe this caution may result in damage to the servo drive and servo motor.

Caution: Do not use dual power supply. Failure to observe this caution may result in damage to the servo drive and servo motor.

Standard Connection Examples

Torque (T) Control Mode

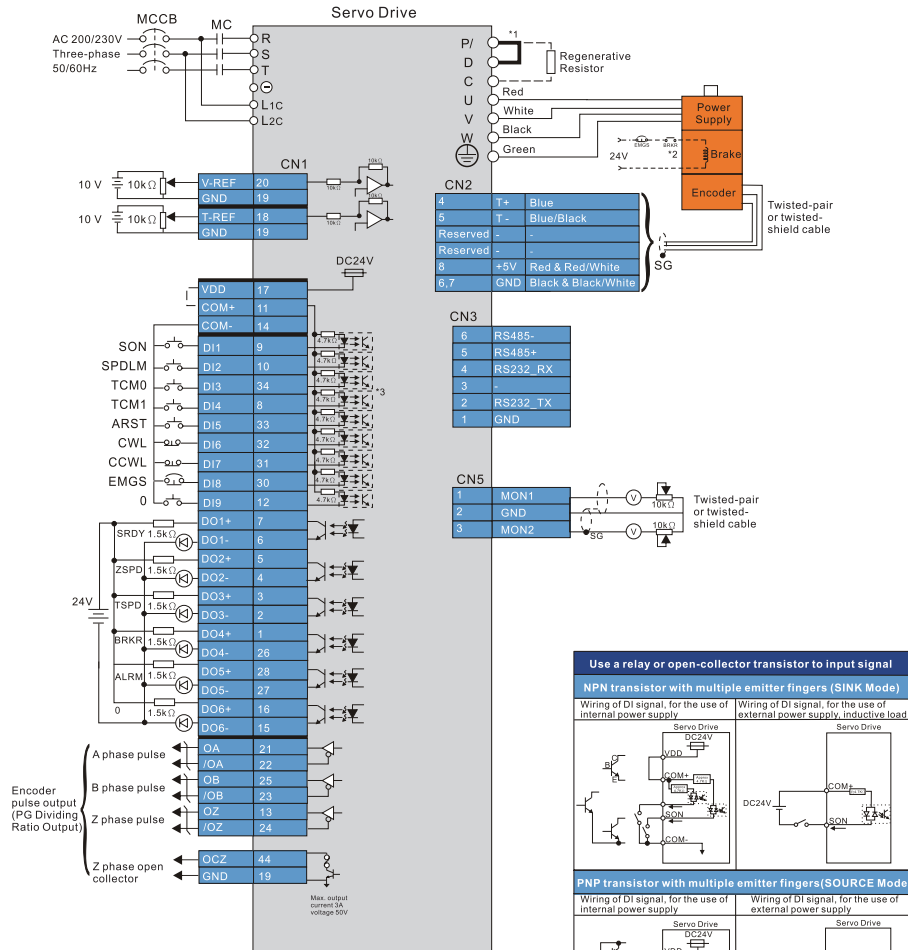

NOTE:
 *1. 400W and below drives do not provide built-in regenerative resistor.
 *2. The brake coil has no polarity.
 *3. Please refer to SINK / SOURCE modes

Regenerative Resistor

Servo Drive (kW)	Recommended Specifications for Built-in Regenerative Resistor		Recommended Specifications for External Regenerative Resistor	Min. Allowable Resistance (Ohm)
	Resistance (Ohm) (parameter P1-52)	Capacity (Watt) (parameter P1-53)		
0.1	--	--	80Ω	60Ω
0.2	--	--	80Ω	60Ω
0.4	100Ω	60W	80Ω	60Ω
0.75	100Ω	60W	80Ω	60Ω
1.0	40Ω	60W	40Ω	30Ω
1.5	40Ω	60W	40Ω	30Ω
2.0	20Ω	100W	30Ω	15Ω
3.0	20Ω	100W	30Ω	15Ω

Note:
 ♦ There is no built-in regenerative resistor for 200W and below ASDA-B2 series servo drives.
 ♦ When the fault, ALE05 (Regeneration Error) occurs, please increase the regenerative resistor capacity or decrease the regenerative resistor resistance (the regenerative resistor resistance should not be less than the minimum allowable resistance listed in the above table.)
 ♦ If the situation is not improved after increasing the regenerative resistor capacity or decreasing the regenerative resistor resistance, please purchase regenerative resistor module.
 ♦ When combining multiple small-capacity regenerative resistors in parallel to increase the regenerative resistor capacity, make sure that the total resistance value of the regenerative resistors should not be less than the minimum allowable resistance listed in the above table.

Safety Information

Global Standards	ASDA-B2 series is designed to fully comply with demanding international standards, i.e. IEC and EN, etc. for all fields of industrial automation technology.	
EMS standard	EN61000-4-6	Level 3
	EN61000-4-3	Level 3
	EN61000-4-2	Level 2 and 3
	EN61000-4-4	Level 3
	EN61000-4-8	Level 4
EN61000-4-5	Level 3	
Conducted & Radiated Emissions	Complies with EN55011 Class A Group 1, with external EMC filter	
CE Marking	CE recognized. Complies with Directive 2006/95/EC of the European Parliament and EMC Directive 2004/108/EC.	
Protection Degree	IEC/EN50178, IEC/EN60529 IP20	
Vibration	1G less than 20Hz, 0.6G 20 to 50Hz. Complies with IEC/EN50178	
Shock	15gn 11ms. Complies with IEC/EN600028-2-27	
Pollution Degree	Degree 2. Complies with IEC/EN61800-5-1	
Ambient Temperature	Operating: 0C~55C (If operating temperature exceeds the specifications, forced cooling will be required.) Storage: -20C~65C	
Cooling Type	ASD-B2-0121-B, ASD-B2-0221-B, ASD-B2-0421-B, ASD-B2-0721-B Natural Air Circulation ASD-B2-1021-B, ASD-B2-1521-B, ASD-B2-2023-B, ASD-B2-3023-B Fan Cooling	
Altitude	Altitude 1000m or lower above sea level	

IEC: International Electrotechnical Commission
 EN: Europäischen Normen
 EMC: Electromagnetic Compatibility
 IP: Ingress Protection Ratings

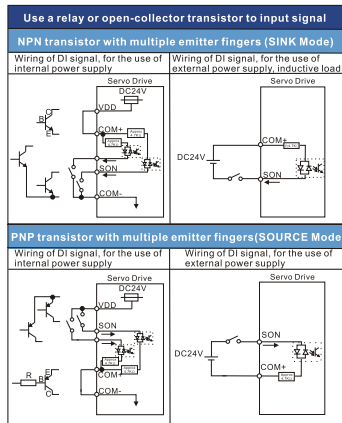

Caution: Do not use dual power supply. Failure to observe this caution may result in damage to the servo drive and servo motor.

Specifications

ASDA-B2 Series		100W	200W	400W	750W	1kW	1.5kW	2kW	3kW	
		01	02	04	07	10	15	20	30	
Power Supply	Phase / Voltage	Three-phase : 170 ~ 255VAC · 50/60Hz 5%						Three-phase 170~255VAC · 50/60Hz 5%		
	Continuous Output Current	0.9 Arms	1.55 Arms	2.6 Arms	5.1 Arms	7.3 Arms	8.3 Arms	13.4 Arms	19.4 Arms	
Cooling System		Natural Air Circulation			Fan Cooling					
Encoder Resolution / Feedback Resolution		17-bit (160,000 p/rev)								
Control of Main Circuit		SVPWM Control								
Tuning Modes		Auto / Manual								
Dynamic Brake		None			Built-in					
Position Control Mode	Max. Input Pulse Frequency	Max. 500Kpps (Line driver) (low speed) / Max. 4Mpps (Line receiver) (high speed) Max. 200Kpps (Open collector)								
	Pulse Type	Pulse + Direction : A phase + B phase : CCW pulse + CW pulse								
	Command Source	External pulse train / Internal parameters								
	Smoothing Strategy	Low-pass and Moving filter								
	Electronic Gear	Electronic gear N/M multiple N: 1 ~ (2 ²⁶ -1), M: 1 ~ (2 ³¹ -1) (1/50<N/M<25600)								
	Torque Limit Operation	Set by parameters								
Feed Forward Compensation		Speed Control Mode								
Speed Control Mode	Analog Input Command	Voltage Range	0 ~ ± 10 V _{DC}							
		Input Resistance	10K							
		Time Constant	2.2 us							
	Speed Control Range ¹	1:5000								
	Command Source	External analog signal / Internal parameters								
	Smoothing Strategy	Low-pass and S-curve filter								
	Torque Limit Operation	Set by parameters or via Analog input								
	Frequency Response Characteristic	Maximum 550Hz								
	Speed Fluctuation Rate ²	0.01% or less at load fluctuation 0 to 100% (at rated speed)								
		0.01% or less at power fluctuation ±10% (at rated speed)								
0.01% or less at ambient temperature fluctuation 0 °C to 50 °C (at rated speed)										
Torque Control Mode	Analog Input Command	Voltage Range	0 ~ ± 10 V _{DC}							
		Input Resistance	10K							
		Time Constant	2.2 us							
	Command Source	External analog signal / Internal parameters								
	Speed Limit Operation	Parameter Setting or via Analog input								

ASDA-B2 Series		100W	200W	400W	750W	1kW	1.5kW	2kW	3kW
		01	02	04	07	10	15	20	30
Analog Monitor Output		Monitor signal can set by parameters (Output voltage range: ±8V)							
Digital Input/ Output	Input	Servo On, Reset, Gain switching, Pulse clear, Zero speed CLAMP, Speed/Torque limit enabled, Emergency stop, Forward / Reverse inhibit limit, Position / Speed mode switching, Speed / Torque mode switching, Torque / Position mode switching, Feed step selection input, Feed step mode input, Auto run input, Electronic gear ratio (Numerator) selection							
	Output	Encoder signal output (A, B, Z Line Driver / Z Open collector) Servo ready, Servo On, At Zero speed, At Speed reached, At Positioning completed, At Torques limit, Servo alarm (Servo fault) activated, Electromagnetic brake control, Homing completed, Output overload warning Servo warning activated, Internal position command completed							
Protective Functions		Overcurrent, Overvoltage, Undervoltage, Regeneration error, Overload, Overspeed, Abnormal pulse control command, Excessive deviation, Watch dog execution time out, Encoder error, Adjustment error, Emergency stop activated, Reverse/ Forward limit switch error, IGBT temperature error, Memory error, DSP communication error, Serial communication error, Input power phase loss, Serial communication time out, Command write-in error, terminals with short circuit protection (U, V, W, CN1, CN2, CN3 terminals)							
Communication Interface		RS-232 / RS-485							
Environment	Installation Site	Indoor location (free from direct sunlight), no corrosive liquid and gas (far away from oil mist, flammable gas, dust)							
	Altitude	Altitude 1000m or lower above sea level							
	Atmospheric Pressure	86kPa ~ 106kPa							
	Operating Temperature	0°C ~ 55°C (If operating temperature is above 45°C, forced cooling will be required)							
	Storage Temperature	-20°C ~ 65°C							
	Humidity	0 to 90% (non-condensing)							
	Vibration	20Hz以下 9.80665m/s ² (1G) · 20 ~ 50Hz 5.88m/s ² (0.6G)							
	IP Rating	IP20							
	Power System	TN System ³							
	Approvals	IEC/EN 61800-5-1  							

Footnote:

- *1 Rated rotation speed: When full load, speed ratio is defined as the minimum speed (the motor will not pause).
- *2 When command is rated rotation speed, the speed fluctuation rate is defined as: (Empty load rotation speed - Full load rotation speed) / Rated rotation speed
- *3 TN system: A power distribution system having one point directly earthed, the exposed conductive parts of the installation being connected to that point by a protective earth conductor.



Dimensions

100W / 200W / 400W

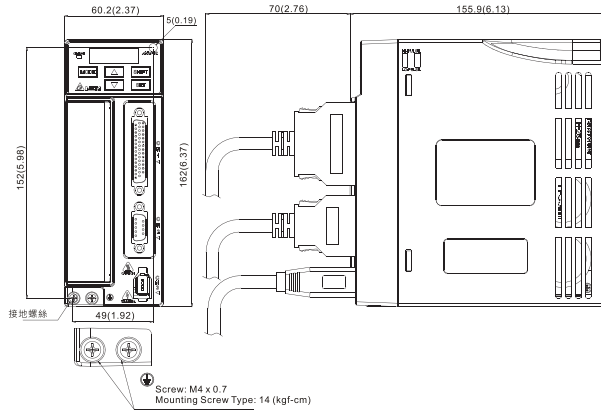

Weight
1.07 (2.36)

NOTE 1)Dimensions are in millimeters (inches); Weights are in kilograms (kg) and (pounds (lbs)).
2)Dimensions and weights of the servo drives may be revised without prior notice.

1kW / 1.5kW

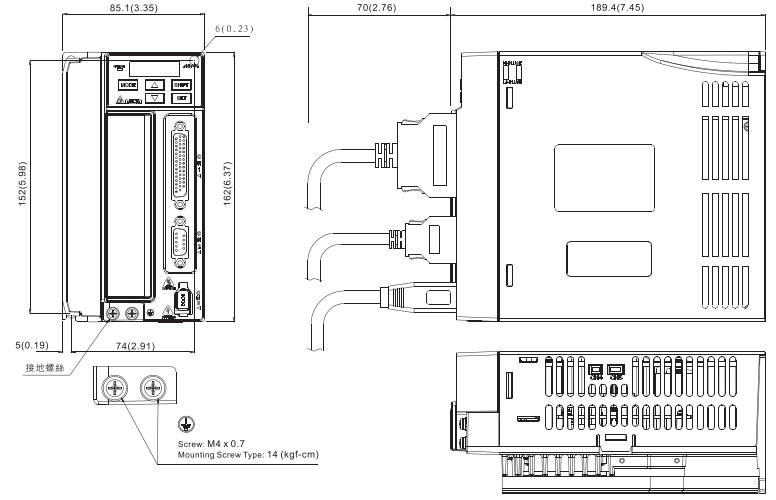

Weight
1.72 (3.79)

NOTE 1)Dimensions are in millimeters (inches); Weights are in kilograms (kg) and (pounds (lbs)).
2)Dimensions and weights of the servo drives may be revised without prior notice.

750W

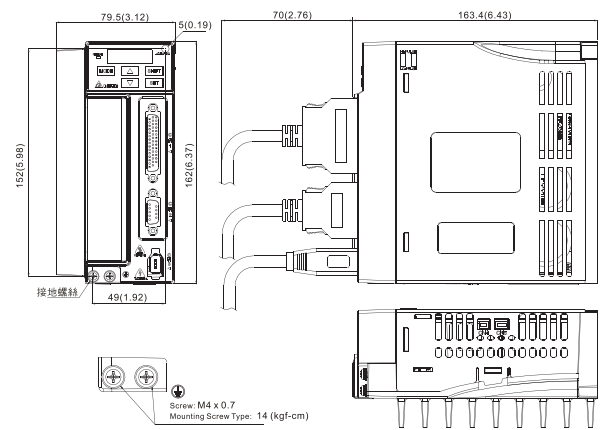

Weight
1.54 (3.40)

NOTE 1)Dimensions are in millimeters (inches); Weights are in kilograms (kg) and (pounds (lbs)).
2)Dimensions and weights of the servo drives may be revised without prior notice.

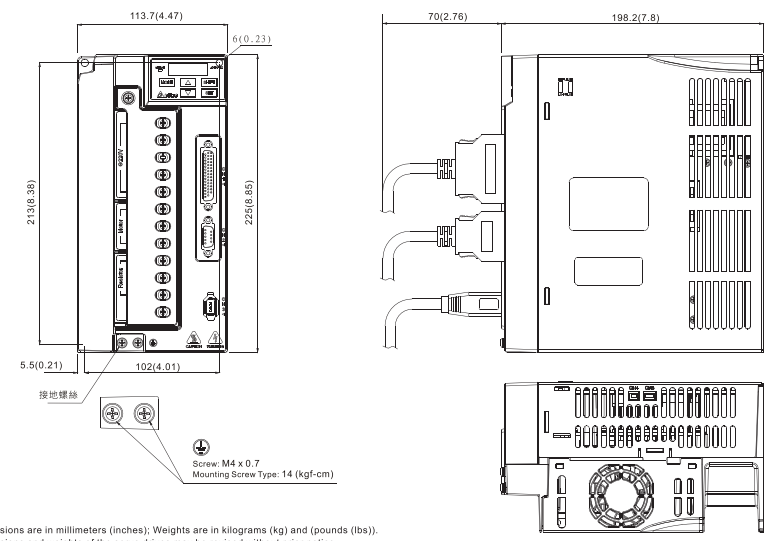

2kW / 3kW



Weight
2.67 (5.88)



NOTE 1)Dimensions are in millimeters (inches); Weights are in kilograms (kg) and (pounds (lbs)).
2)Dimensions and weights of the servo drives may be revised without prior notice.

ECMA Specifications Low Inertia Series

Model: ECMA Series	C△04			C△06			C△08			C△09			C△10	
	01	02	04	04	07	07	10	10	20					
Rated output power (kW)	0.1	0.2	0.4	0.4	0.75	0.75	1.0	1.0	2.0					
Rated torque (N·m) ¹⁾	0.32	0.64	1.27	1.27	2.39	2.39	3.18	3.18	6.37					
Maximum torque (N·m)	0.96	1.92	3.82	3.82	7.16	7.14	8.78	9.54	19.1					
Rated speed (r/min)	3000			3000			3000		3000					
Maximum speed (r/min)	5000			3000			5000							
Rated current (A)	0.90	1.55	2.60	2.60	5.10	3.66	4.25	7.30	12.05					
Maximum current (A)	2.70	4.65	7.80	7.24	15.3	11	12.37	21.9	36.15					
Power rating (kW/s)	27.7	22.4	57.6	22.1	48.4	29.6	38.6	38.1	90.6					
Rotor moment of inertia (× 10 ⁻⁴ kg·m ²)(Without brake)	0.037	0.177	0.277	0.68	1.13	1.93	2.62	2.65	4.45					
Mechanical time constant (ms)	0.75	0.80	0.53	0.73	0.62	1.72	1.20	0.74	0.61					
Torque constant-KT (N·m/A)	0.36	0.41	0.49	0.49	0.47	0.65	0.75	0.44	0.53					
Voltage constant-KE (mV/(r/min))	13.6	16.0	17.4	18.5	17.2	27.5	24.2	16.8	19.2					
Armature resistance (Ohm)	9.30	2.79	1.55	0.93	0.42	1.34	0.897	0.20	0.13					
Armature inductance (mH)	24.0	12.07	6.71	7.39	3.53	7.55	5.7	1.81	1.50					
Electrical time constant (ms)	2.58	4.30	4.30	7.96	8.36	5.66	6.35	9.30	11.4					
Insulation class	Class A (UL), Class B (CE)													
Insulation resistance	>100MΩ · DC 500V													
Insulation strength	1500V AC, 60 seconds													
Weight (kg) (without brake)	0.5	1.2	1.6	2.1	3.0	2.9	3.8	4.3	6.2					
Weight (kg) (with brake)	0.8	1.5	2.0	2.9	3.8	3.69	5.5	4.7	7.2					
Max. radial shaft load (N)	78.4	196	196	245	245	245	245	490	490					
Max. thrust shaft load (N)	39.2	68	68	98	98	98	98	98	98					
Power rating (kW/s) (with brake)	25.6	21.3	53.8	22.1	48.4	29.3	37.9	30.4	82.0					
Rotor moment of inertia (× 10 ⁻⁴ kg·m ²) (with brake)	0.04	0.19	0.30	0.73	1.18	1.95	2.67	3.33	4.95					
Mechanical time constant (ms) (with brake)	0.81	0.85	0.57	0.78	0.65	1.74	1.22	0.93	0.66					
Brake holding torque [Nt·m (min)]	0.3	1.3	1.3	2.5	2.5	2.5	2.5	8.0	8.0					
Brake power consumption (at 20C) [W]	7.2	6.5	6.5	8.2	8.2	8.2	8.2	19.4	19.4					
Brake release time [ms (Max)]	5	10	10	10	10	10	10	10	10					
Brake pull-in time [ms (Max)]	25	70	70	70	70	70	70	70	70					
Vibration grade (μm)	15													
Operating temperature (C)	0 ~ 40													
Storage temperature (C)	-10 ~ 80													
Operating humidity	20 ~ 90%RH (non-condensing)													
Storage humidity	20 ~ 90%RH (non-condensing)													
Vibration capacity	2.5G													
IP Rating	IP65 (when waterproof connectors are used, or when an oil seal is used to be fitted to the rotating shaft (an oil seal model is used))													
Approvals	 													

Footnote: ¹⁾ Rate torque values are continuous permissible values at 0~40°C ambient temperature when attaching with the sizes of heatsinks listed below:
 ECMA_04 (S): 250mm x 250mm x 40mm
 ECMA_10: 300mm x 300mm x 12mm
 ECMA_13: 400mm x 400mm x 20mm
 ECMA_18: 550mm x 550mm x 30mm
 Material type: Aluminum F40, F50, F80, F100, F130, F180
²⁾ The holding brake is used to hold the motor shaft, not for braking the rotation. Never use it for decelerating or stopping the machine.
³⁾ For the specifications of the motors with relay magnetic encoders, please refer to the specifications of the corresponding standard models.
⁴⁾ (Δ) in the model names are for encoder resolution types (Δ1: Incremental encoder, 20-bit; Δ2: Incremental encoder, 17-bit).

Medium / High Inertia Series

Model: ECMA Series	E△13				E△18		F△18	G△13		
	05	10	15	20	20	30	30	03	06	09
Rated output power (kW)	0.5	1.0	1.5	2.0	2.0	3.0	3.0	0.3	0.6	0.9
Rated torque (N·m) ¹⁾	2.39	4.77	7.16	9.55	9.55	14.32	19.10	2.86	5.73	8.59
Maximum torque (N·m)	7.16	14.32	21.48	28.65	28.65	42.97	57.29	8.59	17.19	21.48
Rated speed (r/min)	2000						1500	1000		
Maximum speed (r/min)	3000						2000			
Rated current (A)	2.9	5.6	8.3	11.01	11.22	16.1	19.4	2.5	4.8	7.5
Maximum current (A)	8.7	16.8	24.81	33.03	33.66	48.3	58.2	7.44	14.49	22.5
Power rating (kW/s)	7.0	27.1	45.9	62.5	26.3	37.3	66.4	10.0	39.0	66.0
Rotor moment of inertia (× 10 ⁻⁴ kg·m ²)(Without brake)	8.17	8.41	11.18	14.59	34.68	54.95	54.95	8.17	8.41	11.18
Mechanical time constant (ms)	1.91	1.51	1.11	0.96	1.62	1.06	1.28	1.84	1.40	1.07
Torque constant-KT (N·m/A)	0.83	0.85	0.87	0.87	0.85	0.89	0.98	1.15	1.19	1.15
Voltage constant-KE (mV/(r/min))	30.9	31.9	31.8	31.8	31.4	32.0	35.0	42.5	43.8	41.6
Armature resistance (Ohm)	0.57	0.47	0.26	0.174	0.119	0.052	0.077	1.06	0.82	0.43
Armature inductance (mH)	7.39	5.99	4.01	2.76	2.84	1.38	1.27	14.29	11.12	6.97
Electrical time constant (ms)	12.96	12.88	15.31	15.86	23.87	26.39	16.51	13.55	13.55	16.06
Insulation class	Class A (UL), Class B (CE)									
Insulation resistance	>100MΩ · DC 500V									
Insulation strength	1500V AC, 60 seconds									
Weight (kg) (without brake)	6.8	7.0	7.5	7.8	13.5	18.5	18.5	6.8	7.0	7.5
Weight (kg) (with brake)	8.2	8.4	8.9	9.2	17.5	22.5	22.5	8.2	8.4	8.9
Max. radial shaft load (N)	490	490	490	490	1176	1470	1470	490	490	490
Max. thrust shaft load (N)	98	98	98	98	490	490	490	98	98	98
Power rating (kW/s) (with brake)	6.4	24.9	43.1	59.7	24.1	35.9	63.9	9.2	35.9	62.1
Rotor moment of inertia (× 10 ⁻⁴ kg·m ²) (with brake)	8.94	9.14	11.90	15.88	37.86	57.06	57.06	8.94	9.14	11.9
Mechanical time constant (ms) (with brake)	2.07	1.64	1.19	1.05	1.77	1.10	1.33	2.0	1.51	1.13
Brake holding torque [Nt·m (min)]	10.0	10.0	10.0	10.0	25.0	25.0	25.0	10.0	10.0	10.0
Brake power consumption (at 20C) [W]	21.0	21.0	21.0	21.0	20.4	20.4	20.4	19.0	19.0	19.0
Brake release time [ms (Max)]	10.0	10.0	10.0	10.0	5.0	10.0	10.0	10.0	10.0	10.0
Brake pull-in time [ms (Max)]	25.0	25.0	25.0	25.0	25.0	25.0	25.0	25.0	25.0	25.0
Vibration grade (μm)	15									
Operating temperature (C)	0 ~ 40									
Storage temperature (C)	-10 ~ 80									
Operating humidity	20 ~ 90%RH(non-condensing)									
Storage humidity	20 ~ 90%RH(non-condensing)									
Vibration capacity	2.5G									
IP Rating	IP65 (when waterproof connectors are used, or when an oil seal is used to be fitted to the rotating shaft (an oil seal model is used))									
Approvals	 									

Footnote: ¹⁾ Rate torque values are continuous permissible values at 0~40°C ambient temperature when attaching with the sizes of heatsinks listed below:
 ECMA_04 (S): 250mm x 250mm x 40mm
 ECMA_10: 300mm x 300mm x 12mm
 ECMA_13: 400mm x 400mm x 20mm
 ECMA_18: 550mm x 550mm x 30mm
 Material type: Aluminum F40, F50, F80, F100, F130, F180
²⁾ The holding brake is used to hold the motor shaft, not for braking the rotation. Never use it for decelerating or stopping the machine.
³⁾ For the specifications of the motors with relay magnetic encoders, please refer to the specifications of the corresponding standard models.
⁴⁾ (Δ) in the model names are for encoder resolution types (Δ1: Incremental encoder, 20-bit; Δ2: Incremental encoder, 17-bit).

Dimensions

Motors - Frame Size 86mm and below (Units: mm)

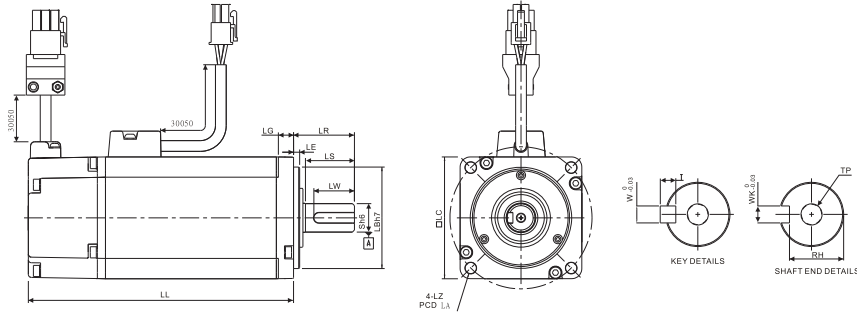

Model	C△0401□S	C△0602□S	C△0604□S	C△0804□S	C△0807□S	C△0907□S	C△0910□S
LC	40	60	60	80	80	86	86
LZ	4.5	5.5	5.5	6.6	6.6	6.6	6.6
LA	46	70	70	90	90	100	100
S	8 ⁺⁰ _(-0.009)	14 ⁺⁰ _(-0.011)	14 ⁺⁰ _(-0.011)	14 ⁺⁰ _(-0.011)	19 ⁺⁰ _(-0.013)	16 ⁺⁰ _(-0.011)	16 ⁺⁰ _(-0.011)
LB	30 ⁺⁰ _(-0.021)	50 ⁺⁰ _(-0.025)	50 ⁺⁰ _(-0.025)	70 ⁺⁰ _(-0.030)	70 ⁺⁰ _(-0.030)	80 ⁺⁰ _(-0.030)	80 ⁺⁰ _(-0.030)
LL(Without Brake)	100.6	105.5	130.7	112.3	138.3	130.2	153.2
LL(With Brake)	136.6	141.6	166.8	152.8	178	161.3	184.3
LS(Without Oil Seal)	20	27	27	27	32	30	30
LS(With Oil Seal)	20	24	24	24.5	29.5	30	30
LR	25	30	30	30	35	35	35
LE	2.5	3	3	3	3	3	3
LG	5	7.5	7.5	8	8	8	8
LW	16	20	20	20	25	20	20
RH	6.2	11	11	11	15.5	13	13
WK	3	5	5	5	6	5	5
W	3	5	5	5	6	5	5
T	3	5	5	5	6	5	5
TP	M3 Depth 8	M4 Depth 15	M4 Depth 15	M4 Depth 15	M6 Depth 20	M5 Depth 15	M5 Depth 15

- NOTE**
- Dimensions are in millimeters. Weights are in kilograms (kg) and (pounds (lbs)).
 - Dimensions and weights of the servo motor may be revised without prior notice.
 - Except ECMA-CM0604PS LL: 116.2mm, for the specifications of the motors with rotary magnetic encoders, please refer to the corresponding standard models.
 - in the model names are for optional configurations (keyway, brake and oil seal).
 - △ in the model names are for encoder resolution types (△=1: Incremental encoder, 20-bit; △=2: Incremental encoder, 17-bit).

Speed-Torque Curves (T-N Curves)

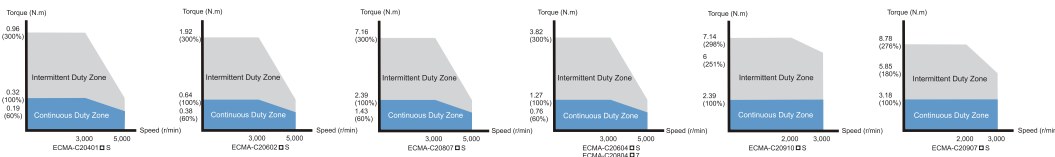

Motors - Frame Size 100mm ~ 130mm (Units: mm)

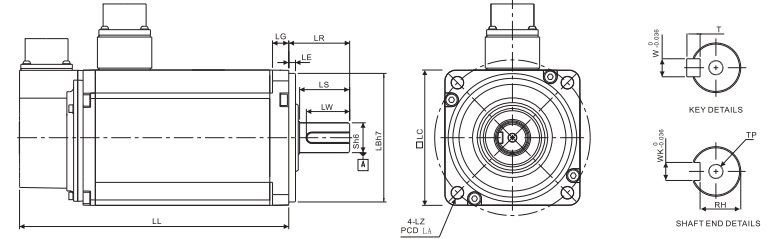

Model	G△1303□S	E△1305□S	G△1306□S	G△1309□S	C△1010□S
LC	130	130	130	130	100
LZ	9	9	9	9	9
LA	145	145	145	145	115
S	22 ⁺⁰ _(-0.013)	22 ⁺⁰ _(-0.013)	22 ⁺⁰ _(-0.013)	22 ⁺⁰ _(-0.013)	22 ⁺⁰ _(-0.013)
LB	110 ⁺⁰ _(-0.035)	110 ⁺⁰ _(-0.035)	110 ⁺⁰ _(-0.035)	110 ⁺⁰ _(-0.035)	95 ⁺⁰ _(-0.035)
LL(Without Brake)	147.5	147.5	147.5	163.5	153.3
LL(With Brake)	183.5	183.5	183.5	198	192.5
LS	47	47	47	47	37
LR	55	55	55	55	45
LE	6	6	6	6	5
LG	11.5	11.5	11.5	11.5	12
LW	36	36	36	36	32
RH	18	18	18	18	18
WK	8	8	8	8	8
W	8	8	8	8	8
T	7	7	7	7	7
TP	M6 Depth 20	M6 Depth 20	M6 Depth 20	M6 Depth 20	M6 Depth 20

- NOTE**
- Dimensions are in millimeters. Weights are in kilograms (kg) and (pounds (lbs)).
 - Dimensions and weights of the servo motor may be revised without prior notice.
 - Except ECMA-CM0604PS LL: 116.2mm, for the specifications of the motors with rotary magnetic encoders, please refer to the corresponding standard models.
 - in the model names are for optional configurations (keyway, brake and oil seal).
 - △ in the model names are for encoder resolution types (△=1: Incremental encoder, 20-bit; △=2: Incremental encoder, 17-bit).

Speed-Torque Curves (T-N Curves)

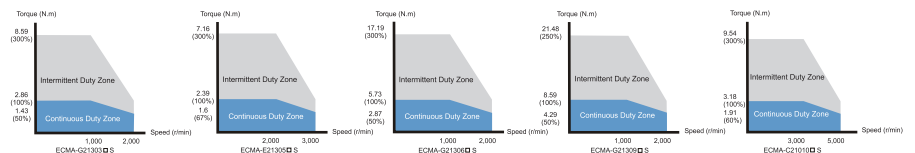

Dimensions

Motors - Frame Size 100mm ~ 130mm (Units: mm)

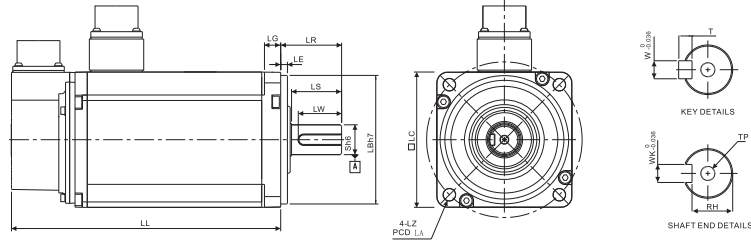

Model	E△1310□S	E△1315□S	C△1020□S	E△1320□S
LC	130	130	100	130
LZ	9	9	9	9
LA	145	145	115	145
S	22(+0/-0.013)	22(+0/-0.013)	22(+0/-0.013)	22(+0/-0.013)
LB	110(+0/-0.035)	110(+0/-0.035)	95(+0/-0.035)	110(+0/-0.035)
LL(Without Brake)	147.5	167.5	199	187.5
LL(With Brake)	183.5	202	226	216
LS	47	47	37	47
LR	55	55	45	55
LE	6	6	5	6
LG	11.5	11.5	12	11.5
LW	36	36	32	36
RH	18	18	18	18
WK	8	8	8	8
W	8	8	8	8
T	7	7	7	7
TP	M6 Depth 20	M6 Depth 20	M6 Depth 20	M6 Depth 20



- NOTE**
1. Dimensions are in millimeters. Weights are in kilograms (kg) and (pounds (lbs)).
 2. Dimensions and weights of the servo motor may be revised without prior notice.
 3. Except ECMA-CM0604PS LL:116.2mm, for the specifications of the motors with rotary magnetic encoders, please refer to the corresponding standard models.
 4. (□) in the model names are for optional configurations (keyway, brake and oil seal).
 5. (△) in the model names are for encoder resolution types (△=1: Incremental encoder, 20-bit; △=2: Incremental encoder, 17-bit).

Speed-Torque Curves (T-N Curves)

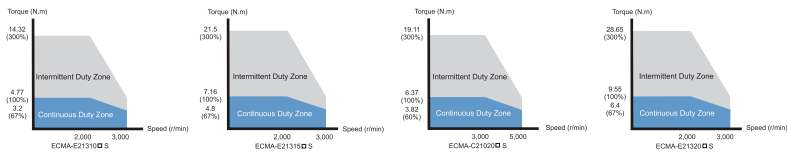

Motors - Frame Size 180mm and above (Units: mm)

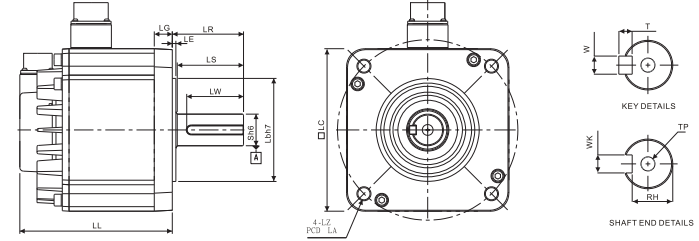

Model	E△1820□S	E△1830□S	F△1830□S
LC	180	180	180
LZ	13.5	13.5	13.5
LA	200	200	200
S	35(+0/-0.016)	35(+0/-0.016)	35(+0/-0.016)
LB	114.3(+0/-0.035)	114.3(+0/-0.035)	114.3(+0/-0.035)
LL(Without Brake)	169	202.1	202.1
LL(With Brake)	203.1	235.3	235.3
LS	73	73	73
LR	79	79	79
LE	4	4	4
LG	20	20	20
LW	63	63	63
RH	30	30	30
WK	10 ⁰ / _{-0.036}	10 ⁰ / _{-0.036}	10 ⁰ / _{-0.036}
W	10 ⁰ / _{-0.036}	10 ⁰ / _{-0.036}	10 ⁰ / _{-0.036}
T	8	8	8
TP	M12 Depth 25	M12 Depth 25	M12 Depth 25



- NOTE**
1. Dimensions are in millimeters. Weights are in kilograms (kg) and (pounds (lbs)).
 2. Dimensions and weights of the servo motor may be revised without prior notice.
 3. Except ECMA-CM0604PS LL:116.2mm, for the specifications of the motors with rotary magnetic encoders, please refer to the corresponding standard models.
 4. (□) in the model names are for optional configurations (keyway, brake and oil seal).
 5. (△) in the model names are for encoder resolution types (△=1: Incremental encoder, 20-bit; △=2: Incremental encoder, 17-bit).

Speed-Torque Curves (T-N Curves)

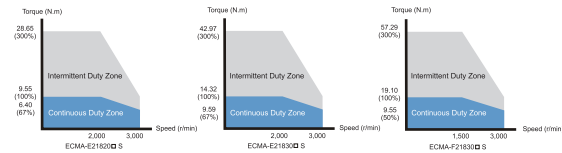

Optional Accessories

Power Cables

- 3m and 5m standard cables are available.
- Customized service is offered to meet the needs of customers.
- Two types are selectable: with brake and without brake.



CN1 I/O Connectors

- Used to connect to external (host) controller



CN1 Convenient Connector

- Delta Part Number: ASD-IFDS44
- *Available for ordering soon



Encoder Cables

- 3m and 5m standard cables are available.
- Customized service is offered to meet the needs of customers.



Regenerative Resistors

- 400W/40Ohm and 1kW/20Ohm two kinds of specifications are available.
- For selecting a regenerative resistor, please refer to the table of regenerative resistor specifications on page 12.

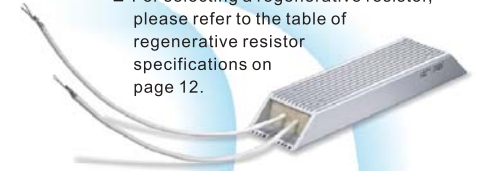

Terminal Block Modules

- 0.5M connection cable is provided. Easy to reduce the space required.
- Delta Part Number: ASD-MDDS44
- *Available for ordering soon



RS-485 Connectors

- Used to connect multiple Delta ASDA series products by RS-485 interface through Modbus serial communication.
- Delta Part Number: ASD-CNIE0B06



ASD-Soft Software Communication Cables (for PC)

- Delta Part Number: ASD-CNUS0A08



Optional Accessories

Power Connectors

ASDBCAPW000



Title	Part No.	Manufacturer
Housing	C4201H00-2*2PA	JOWLE
Terminal	C4201TOP-2	JOWLE

ASD-CAPW1000

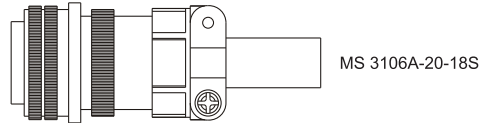

ASDBCAPW0100

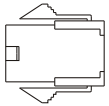

Title	Part No.	Manufacturer
Housing	C4201H00-2*3PA	JOWLE
Terminal	C4201TOP-2	JOWLE

ASD-CAPW2000

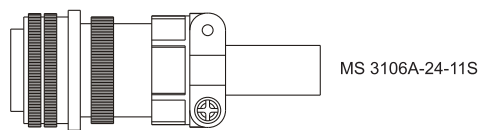

Power Cables

ASDBCAPW0203/0205

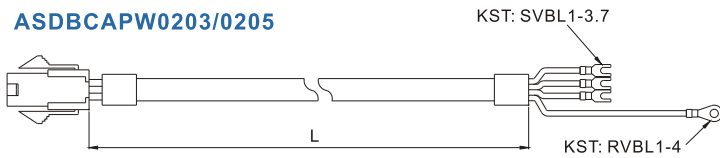

Title	Part No.	Manufacturer
Housing	C4201H00-2*2PA	JOWLE
Terminal	C4201TOP-2	JOWLE

Title	Part No.	mm	L	inch
1	ASDBCAPW0203	3000 ± 50		118 ± 2
2	ASDBCAPW0205	5000 ± 50		197 ± 2

ASDBCAPW0303/0305

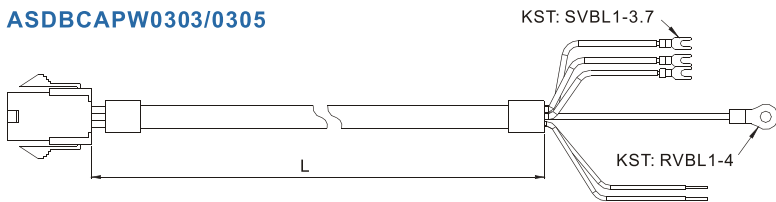

Title	Part No.	Manufacturer
Housing	C4201H00-2*3PA	JOWLE
Terminal	C4201TOP-2	JOWLE

Title	Part No.	mm	L	inch
1	ASDBCAPW0303	3000 ± 50		118 ± 2
2	ASDBCAPW0305	5000 ± 50		197 ± 2

Power Cables

ASDBCAPW1203/1205

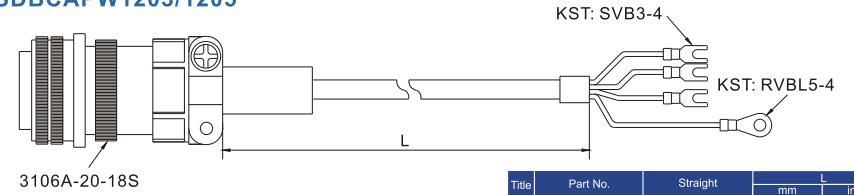

Title	Part No.	Straight	mm	L	inch
1	ASDBCAPW1203	3106A-20-18S	3000 ± 50		118 ± 2
2	ASDBCAPW1205	3106A-20-18S	5000 ± 50		197 ± 2

ASDBCAPW1303/1305

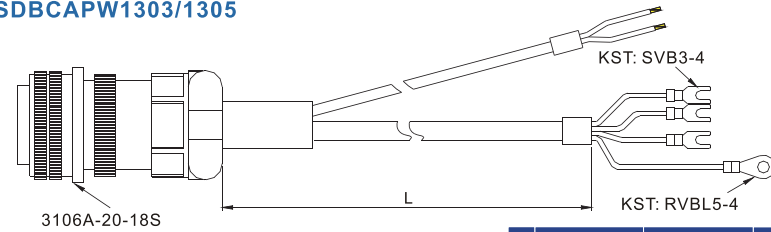

Title	Part No.	Straight	mm	L	inch
1	ASDBCAPW1303	3106A-20-18S	3000 ± 50		118 ± 2
2	ASDBCAPW1305	3106A-20-18S	5000 ± 50		197 ± 2

ASD-CAPW2203/2205

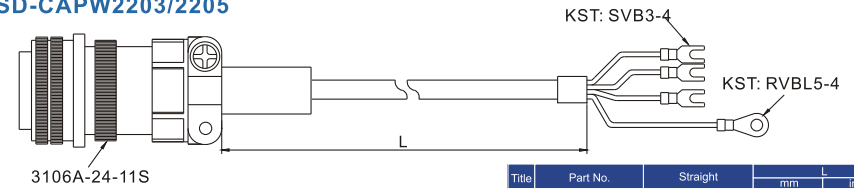

Title	Part No.	Straight	mm	L	inch
1	ASD-CAPW2203	3106A-24-11S	3000 ± 50		118 ± 2
2	ASD-CAPW2205	3106A-24-11S	5000 ± 50		197 ± 2

ASD-CAPW2303/2305

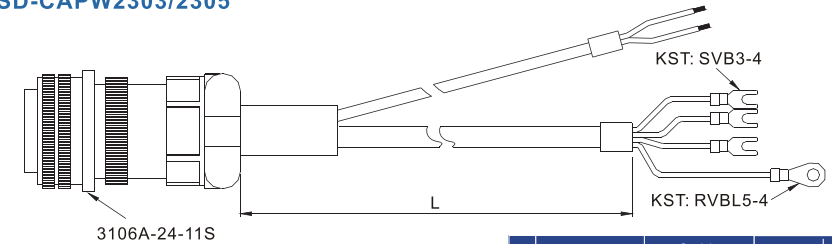

Title	Part No.	Straight	mm	L	inch
1	ASD-CAPW2303	3106A-24-11S	3000 ± 50		118 ± 2
2	ASD-CAPW2305	3106A-24-11S	5000 ± 50		197 ± 2

Optional Accessories

Encoder Connectors

ASDBCAEN0000

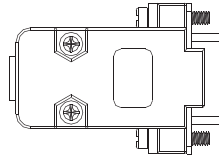

D-SUB Connector 9P

Title	Part No.	Manufacturer
Housing	AMP(1-172161-9)	AMP
Terminal	AMP(170359-3)	AMP
CLAMP	DELTA(34703237XX)	DELTA

ASDBCAEN1000

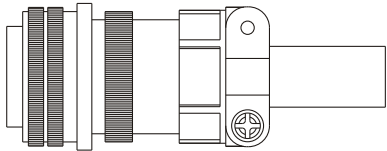

3106A-20-29S

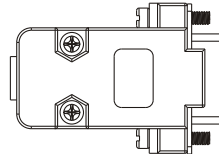

D-SUB Connector 9P

Encoder Cables

ASDBCAEN0003/0005

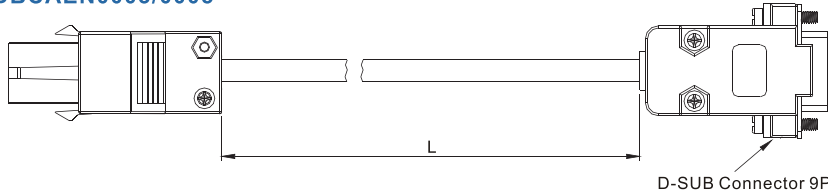

D-SUB Connector 9P

Title	Part No.	L			
		mm	inch		
1	ASDBCAEN0003	3000	50	118	2
2	ASDBCAEN0005	5000	50	197	2

Title	Part No.	Manufacturer
Housing	AMP(1-172161-9)	AMP
Terminal	AMP(170359-3)	AMP
CLAMP	DELTA(34703237XX)	DELTA

ASDBCAEN1003/1005

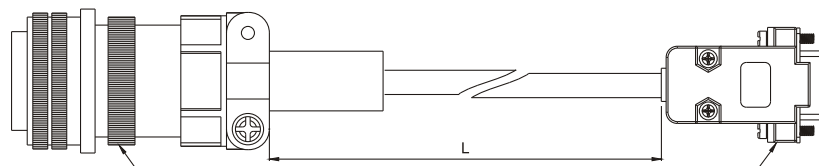

3106A-20-29S

D-SUB Connector 9P

I/O Signal Connector

ASDECNDS0044

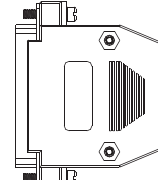

D-SUB 44 PIN PLUG

RS-485 Connector

ASD-CNIE0B06

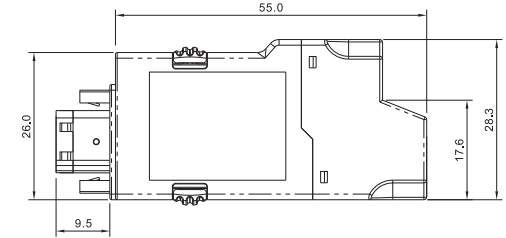

NOTE
 1. Other accessories for ASDA-B2 series will be increased gradually.
 2. Accessories images shown here may differ from actual product. Please refer to the actual product appearance.

Communication Cable between Drive and Computer (for PC)

ASD-CNUS0A08

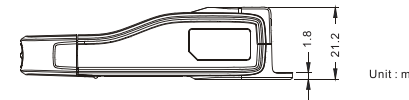
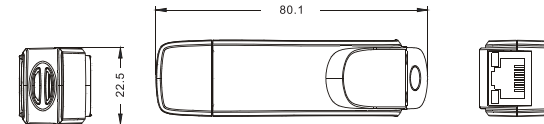
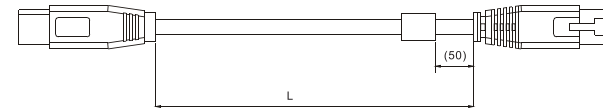

Unit : mm

Title	Part No. : ASD-CNUS0A08	
Cable	L	3000 ± 100 mm
		118 ± 4 inch
Connector	RJ connector	RJ-45
	USB connector	A-type (USB V2.0)

Voltage Output Cable (Analog Signal)

3864471800

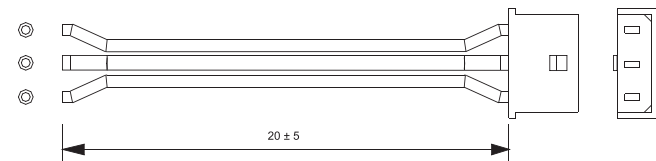

Title	Part No.	Manufacturer
Housing	A2004H00-3P	JWT
Terminal	A2004TOP-2	JWT

Accessories Combinations

100 W Servo Drive and 100W Low Inertia Servo Motor

Servo Drive	ASD-B2-0121-B
Low Inertia Servo Motor	ECMA-C△0401□S
Power-Cables(Without Brake)	ASDBCAPW020X
Power-Connectors(Without Brake)	ASDBCAPW0000
Power-Cables(With Brake)	ASDBCPW030X
Power-Connectors(With Brake)	ASDBCAPW0100
Encoder Cables	ASDBCAEN000X
Encoder Connectors	ASDBCAEN0000

(X=3 indicates that the cable length is 3m; X=5 indicates that the cable length is 5m)

200W Servo Drive and 200W Low Inertia Servo Motor

Servo Drive	ASD-B2-0221-B
Low Inertia Servo Motor	ECMA-C△0602□S
Power-Cables(Without Brake)	ASDBCAPW020X
Power-Connectors(Without Brake)	ASDBCAPW0000
Power-Cables(With Brake)	ASDBCPW030X
Power-Connectors(With Brake)	ASDBCAPW0100
Encoder Cables	ASDBCAEN000X
Encoder Connectors	ASDBCAEN0000

(X=3 indicates that the cable length is 3m; X=5 indicates that the cable length is 5m)

400W Servo Drive and 400W Low Inertia Servo Motor

Servo Drive	ASD-B2-0421-B
Low Inertia Servo Motor	ECMA-C△0604□S ECMA-C△0804□7 ECMA-CM0604PS
Power-Cables(Without Brake)	ASDBCAPW020X
Power-Connectors(Without Brake)	ASDBCAPW0000
Power-Cables(With Brake)	ASDBCPW030X
Power-Connectors(With Brake)	ASDBCAPW0100
Encoder Cables	ASDBCAEN000X
Encoder Connectors	ASDBCAEN0000

(X=3 indicates that the cable length is 3m; X=5 indicates that the cable length is 5m)

400W Servo Drive and 500W Medium Inertia Servo Motor

Servo Drive	ASD-B2-0421-B
Medium Inertia Servo Motor	ECMA-E△1305□S
Power-Cables(Without Brake)	ASDBCAPW120X
Power-Connectors(Without Brake)	ASDBCAPW130X
Power-Connectors	ASD-CAPW1000
Encoder Cables	ASDBCAEN100X
Encoder Connectors	ASDBCAEN1000

(X=3 indicates that the cable length is 3m; X=5 indicates that the cable length is 5m)

400W Servo Drive and 300W High Inertia Servo Motor

Servo Drive	ASD-B2-0421-B
High Inertia Servo Motor	ECMA-G△1303□S
Power-Cables(Without Brake)	ASDBCAPW120X
Power-Connectors(Without Brake)	ASDBCPW130X
Power-Connectors	ASD-CAPW1000
Encoder Cables	ASDBCAEN100X
Encoder Connectors	ASDBCAEN1000

(X=3 indicates that the cable length is 3m; X=5 indicates that the cable length is 5m)

750W Servo Drive and 750W Low Inertia Servo Motor

Servo Drive	ASD-B2-0721-B
Low Inertia Servo Motor	ECMA-C△0807□S ECMA-C△0907□7
Power-Cables(Without Brake)	ASDBCAPW020X
Power-Connectors(Without Brake)	ASDBCAPW0000
Power-Cables(With Brake)	ASDBCPW030X
Power-Connectors(With Brake)	ASDBCAPW0100
Encoder Cables	ASDBCAEN000X
Encoder Connectors	ASDBCAEN0000

(X=3 indicates that the cable length is 3m; X=5 indicates that the cable length is 5m)

Accessories Combinations

7750W Servo Drive and 600W High Inertia Servo Motor

Servo Drive	ASD-B2-0721-B
High Inertia Servo Motor	ECMA-G△1306□S ECMA-GM1306PS
Power-Cables(Wuthout Brake)	ASDBCAPW120X
Power-Cables(With Brake)	ASDBCAPW130X
Power-Connectors	ASD-CAPW01000
Encoder Cables	ASDBCAEN100X
Encoder Connectors	ASDBCAEN1000

(X=3 indicates that the cable length is 3m; X=5 indicates that the cable length is 5m)

1kW Servo Drive and 1kW Medium Inertia Servo Motor

Servo Drive	ASD-B2-1021-B
Medium Inertia Servo Motor	ECMA-E△1310□S
Power-Cables(Wuthout Brake)	ASDBCAPW120X
Power-Cables(With Brake)	ASDBCAPW130X
Power-Connectors	ASD-CAPW1000
Encoder Cables	ASDBCAEN100X
Encoder Connectors	ASDBCAEN1000

(X=3 indicates that the cable length is 3m; X=5 indicates that the cable length is 5m)

1kW Servo Drive and 1kW Low Inertia Servo Motor

Servo Drive	ASD-B2-1021-B
Low Inertia Servo Motor	ECMA-C△1010□S
Power-Cables(Wuthout Brake)	ASDBCAPW120X
Power-Cables(With Brake)	ASDBCAPW130X
Power-Connectors	ASDBCAPW1000
Encoder Cables	ASDBCAEN100X
Encoder Connectors	ASDBCAEN1000

(X=3 indicates that the cable length is 3m; X=5 indicates that the cable length is 5m)

1kW Servo Drive and 900W High Inertia Servo Motor

Servo Drive	ASD-B2-1021-B
High Inertia Servo Motor	ECMA-G△1309□S ECMA-GM1309P7
Power-Cables(Wuthout Brake)	ASDBCAPW120X
Power-Cables(With Brake)	ASDBCAPW130X
Power-Connectors	ASD-CAPW1000
Encoder Cables	ASDBCAEN100X
Encoder Connectors	ASDBCAEN1000

(X=3 indicates that the cable length is 3m; X=5 indicates that the cable length is 5m)

1kW Servo Drive and 1kW Low Inertia Servo Motor

Servo Drive	ASD-B2-1021-B
Low Inertia Servo Motor	ECMA-C△0910□S
Power-Cables(Wuthout Brake)	ASDBCAPW020X
Power-Connectors(Wuthout Brake)	ASDBCAPW0000
Power-Cables(With Brake)	ASDBCAPW030X
Power-Connectors(With Brake)	ASDBCAPW0100
Encoder Cables	ASDBCAEN000X
Encoder Connectors	ASDBCAEN0000

(X=3 indicates that the cable length is 3m; X=5 indicates that the cable length is 5m)

1.5kW Servo Drive and 1.5kW Medium Inertia Servo Motor

Servo Drive	ASD-B2-1521-B
Medium Inertia Servo Motor	ECMA-E△1315□S
Power-Cables(Wuthout Brake)	ASDBCAPW120X
Power-Cables(With Brake)	ASDBCAPW130X
Power-Connectors	ASD-CAPW1000
Encoder Cables	ASDBCAEN100X
Encoder Connectors	ASDBCAEN1000

(X=3 indicates that the cable length is 3m; X=5 indicates that the cable length is 5m)

Accessories Combinations

2kW Servo Drive and 2kW Low Inertia Servo Motor

Servo Drive	ASD-B2-2023-B
Low Inertia Servo Motor	ECMA-C△1020□S
Power-Cables(Without Brake)	ASDBCAPW120X
Power-Cables(With Brake)	ASDBCPW130X
Power-Connectors	ASDB-APW1000
Encoder Cables	ASDBCAEN100X
Encoder Connectors	ASDBCAEN1000

(X=3 indicates that the cable length is 3m; X=5 indicates that the cable length is 5m)

3kW Servo Drive and 3kW Medium Inertia Servo Motor

Servo Drive	ASD-B2-3023-B
Medium Inertia Servo Motor	ECMA-E△1820□S
Power-Cables(Without Brake)	ASD-CAPW220X
Power-Cables(With Brake)	ASD-CPW230X
Power-Connectors	ASD-CAPW2000
Encoder Cables	ASDBCAEN100X
Encoder Connectors	ASDBCAEN1000

(X=3 indicates that the cable length is 3m; X=5 indicates that the cable length is 5m)

2kW Servo Drive and 2kW Medium Inertia Servo Motor

Servo Drive	ASD-B2-2023-B
Medium Inertia Servo Motor	ECMA-E△1320□S
Power-Cables(Without Brake)	ASDBCAPW120X
Power-Cables(With Brake)	ASDBCPW130X
Power-Connectors	ASD-CAPW1000
Encoder Cables	ASDBCAEN100X
Encoder Connectors	ASDBCAEN1000

(X=3 indicates that the cable length is 3m; X=5 indicates that the cable length is 5m)

3kW Servo Drive and 3kW Medium Inertia Servo Motor

Servo Drive	ASD-B2-3023-B
Medium Inertia Servo Motor	ECMA-F△1820□S
Power-Cables(Without Brake)	ASD-CAPW220X
Power-Cables(With Brake)	ASD-CPW230X
Power-Connectors	ASD-CAPW2000
Encoder Cables	ASDBCAEN100X
Encoder Connectors	ASDBCAEN1000

(X=3 indicates that the cable length is 3m; X=5 indicates that the cable length is 5m)

2kW Servo Drive and 2kW Medium Inertia Servo Motor

Servo Drive	ASD-B2-2023-B
Medium Inertia Servo Motor	ECMA-E△1820□S
Power-Cables(Without Brake)	ASD-CAPW220X
Power-Cables(With Brake)	ASD-CPW230X
Power-Connectors	ASD-CAPW2000
Encoder Cables	ASDBCAEN100X
Encoder Connectors	ASDBCAEN1000

(X=3 indicates that the cable length is 3m; X=5 indicates that the cable length is 5m)

