



IMfinity[®] 3-phase induction motors

Variable speed and fixed speed

IE2 High efficiency & IE3 Premium efficiency and IE4 Super Premium efficiency motors

Non IE for current or special use

Frame size 56 to 450

Power rating 0.09 to 1250 kW

Leroy-Somer[™]

This catalogue presents the induction motors of the IMfinity® generation, in all their efficiency classes and construction shapes.

IMfinity® motors are designed to reach a very high efficiency, whether supplied directly through mains or controlled by a speed drive.

Premium efficiency IMfinity® aluminium frame motors are designed to comply with European and US energy regulations.

Many other countries in the world impose minimum efficiency levels for electric motors.

Refer to the information presented at the end of the catalogue.



All 2-, 4- et 6-pole motors, from 0.75 to 375 kW, covered by the European directive ErP and marketed in the European Union must be IE2 class from 2011/06/16, then IE3 or IE2 and used with a speed drive:

- from 2015/01/01 for power ratings from 7.5 to 375 kW**
- from 2017/01/01 for power ratings from 0.75 to 375 kW**

Contents

GENERAL	6	IP 55 ALUMINIUM FRAME	63
GENERAL INFORMATION		GENERAL INFORMATION	
Introduction.....	6	Designation.....	64
Quality commitment.....	7	Description.....	65
Directive and standards relating to motor efficiency.....	8	ELECTRICAL AND MECHANICAL DATA	
Standards and approvals.....	9	Non IE efficiency.....	66
ENVIRONMENT		IE2 powered by the mains.....	68
Definition of "Index of Protection".....	12	IE2 powered by the drive.....	70
Environmental limitations.....	13	IE3 powered by the mains.....	72
Impregnation and enhanced protection.....	14	IE3 powered by the drive.....	74
Heaters.....	15	Mains connection.....	76
External finish.....	16	DIMENSIONS	
Interference suppression and protection of people.....	17	Shaft extensions.....	77
CONSTRUCTION		Foot mounted IM 1001 (IM B3).....	78
Mounting arrangements.....	18	Foot and flange mounted IM 2001 (IM B35).....	79
Mains connection.....	19	Flange mounted IM 3001 (IM B5) IM 3011 (IM V1).....	80
Radial loads.....	20	Foot and face mounted IM 2101 (IM B34).....	81
Cooling.....	21	Face mounted IM 3601 (IM B14).....	82
Cooling for LSES/FLSES/PLSES motors.....	23	CONSTRUCTION	
Motor connections.....	24	Bearings and lubrication.....	83
Bearings and bearing life.....	25	Axial loads.....	85
Lubrication and maintenance of bearings.....	26	Radial loads.....	88
OPERATION		OPTIONAL FEATURES	
Duty cycle - Definitions.....	27	Non-standard flanges.....	95
Supply voltage.....	30	Mechanical options.....	96
Insulation class - Temperature rise and thermal reserve.....	32	Mechanical and electrical options.....	97
Starting times and starting current.....	33	INSTALLATION AND MAINTENANCE	
Power - Torque - Efficiency - Power Factor (Cos ϕ).....	34	Position of the lifting rings.....	98
Operation with speed drive.....	37	IP55 CAST IRON FRAME	99
Noise level.....	46	GENERAL INFORMATION	
Weighted sound level [dB(A)].....	47	Designation.....	100
Vibration.....	48	Description.....	101
Optimised performance.....	50	ELECTRICAL AND MECHANICAL DATA	
Starting methods for induction motors.....	51	IE2 powered by the mains.....	102
Braking.....	55	IE2 powered by the drive.....	104
Operation as an asynchronous generator.....	57	IE3 powered by the mains.....	106
ELECTRICAL AND MECHANICAL DATA		IE3 powered by the drive.....	108
Identification.....	59	IE4 powered by the mains.....	110
		IE4 powered by the drive.....	111
		Mains connection.....	112

Contents

DIMENSIONS

Shaft extensions	113
Foot mounted IM 1001 (IM B3).....	114
Foot and flange mounted IM 2001 (IM B35).....	115
Flange mounted IM 3001 (IM B5) IM 3011 (IM V1)	116
Foot and face mounted IM 2101 (IM B34).....	117
Face mounted IM 3601 (IM B14).....	118

CONSTRUCTION

Bearings and lubrication	119
Axial loads	121
Radial loads.....	124

OPTIONAL FEATURES

Non-standard flanges	131
Mechanical options	132
Mechanical and electrical options	133

INSTALLATION AND MAINTENANCE

Position of the lifting rings	134
-------------------------------------	-----

IP23 ALUMINIUM OR STEEL FRAME 135

GENERAL INFORMATION

Designation.....	136
Description.....	137

ELECTRICAL AND MECHANICAL DATA

IE2 powered by the mains.....	138
IE2 powered by the drive.....	139
IE3 powered by the mains.....	140
IE3 powered by the drive.....	142
Mains connection.....	144

DIMENSIONS

Shaft extensions	145
Foot mounted IM 1001 (IM B3).....	146
Foot and flange mounted IM 2001 (IM B35)	147
Flange mounted IM 3001 (IM B5) IM 3011 (IM V1)	148

CONSTRUCTION

Bearings and lubrication	149
Axial loads	150
Radial loads.....	153

OPTIONAL FEATURES

Mechanical options	158
Mechanical and electrical options	158

INSTALLATION AND MAINTENANCE

Position of the lifting rings	159
-------------------------------------	-----

ENERGY REGULATIONS WORLDWIDE 161

Regulations in the main countries	161
---	-----

ENVIRONMENT 162

Environments and special applications.....	162
--	-----

APPENDIX 164

Cable gland support plates	164
Calculating the efficiency of an induction motor	165
Units of measurement and standard formulae	166
Unit conversions	169
Standard formulae used in electrical engineering	170
Tolerance on main performance parameters.....	172
Configurator.....	173
Product availability.....	173
CE Declaration of conformity	174

Index

Ambient temperature	13	Lifting rings	98-134-159
Approvals.....	9	Locked rotor time	33
Availability.....	173	Lubrication	26-83-119-149
Balancing	48	Marking	10
CE conformance	10-17-174	Nameplates	59 to 62
Configurator.....	173	Noise	46
Connection	24	Operating position	18
Connection	19-76-112-144	Options for aluminium motors	95 to 97
Connection diagram.....	19	Options for cast iron motors	123 to 131
CSA	10-11	Options for drip proof motors.....	158
Dimensions of aluminium motors	77 to 82	Performance	44-45
Dimensions of cast iron motors	113 to 118	Permissible axial load	85-121-150
Dimensions of drip-proof motors	145 to 148	Permissible radial load.....	20-27-88-124-153
Direction of rotation	19	Power	34
Drain holes.....	13	Power factor (Cos φ).....	34
Drip covers.....	13-96-132	Quality assurance	7
Earth terminal	19	Serial number	59 to 62
Efficiency	6-8-36-164	Speed of rotation.....	40 to 43
Elec & mech characteristics of aluminium motors	66 to 76	Standards	9
Elec & mech characteristics of cast iron motors	102 to 112	Starting time.....	33
Elec & mech characteristics of drip-proof motors ...	138 to 144	Starts (number of).....	51
Energy regulations.....	161	Supply voltage	30
Environment	12 to 17-162-163	Temperature rise	32
External finish	16	Terminal blocks	76-112-144
Flange	96-132-158	Terminal box	19
Forced ventilation	37-97-133-158	Thermal protection.....	50
Frequency control	37-45	Thermal reserve.....	32
Heaters	15-97-133-158	Tolerance	172
Humidity.....	13	Torque.....	34
IEC	9-11	Units of measurement and formulae	166 to 168
Impregnation.....	14	Vibration	48
Index of protection	12	Vibration level	48
Installation	43 to 45		
Insulation	32-42		
Insulation class	32		
Interference suppression	17		
ISO 9001.....	7		
Key	48		

IMfinity® 3-phase induction motors - IE2 - IE3 - IE4 - Non IE Efficiency

General

General information

Introduction

In this catalogue, Leroy-Somer describes the IMfinity® new generation induction motors.

These motors have been designed to incorporate the latest European

standards, and can satisfy most of industry's demands.

They are par excellence the leading products in the Leroy-Somer range.

Other motors, ranging in power

from **0.045 to 2200 kW** and special construction types, are included in the Leroy-Somer motor programme.

IP55 ALUMINIUM MOTORS



NON IE EFFICIENCY

IP 55 ALUMINIUM ON MAINS*

HIGH EFFICIENCY

IE2 IP55 ALUMINIUM ON MAINS*

IE2 IP55 ALUMINIUM ON DRIVE

PREMIUM EFFICIENCY

IE3 IP55 ALUMINIUM ON MAINS

IE3 IP55 ALUMINIUM ON DRIVE

IP55 CAST IRON MOTORS



HIGH EFFICIENCY

IE2 IP 55 CAST IRON ON MAINS*

IE2 CAST IRON ON DRIVE

PREMIUM EFFICIENCY

IE3 IP55 CAST IRON ON MAINS

IE3 CAST IRON ON DRIVE

SUPER PREMIUM EFFICIENCY

IE4 IP55 CAST IRON ON MAINS

IE4 CAST IRON ON DRIVE

IP23 DRIP-PROOF MOTORS



HIGH EFFICIENCY

IE2 IP23 PROTECTED ON MAINS*

IE2 IP23 PROTECTED ON DRIVE

PREMIUM EFFICIENCY

IE3 IP23 PROTECTED ON MAINS

IE3 IP23 PROTECTED ON DRIVE

For more information, see the "Directives and standards relating to motor efficiency" section.

* Use outside the European Union

IMfinity® 3-phase induction motors - IE2 - IE3 - IE4 - Non IE Efficiency

General

General information

Quality commitment

Leroy-Somer's quality management system is based on:

- Control of procedures right from the initial sales offering until delivery to the customer, including design, manufacturing start-up and production
- A total quality policy based on making continuous progress in improving operational procedures, involving all departments in the company in order to give customer satisfaction as regards delivery times, conformity and cost
- Indicators used to monitor procedure performance
- Corrective actions and advancements with tools such as FMECA, QFD, MAVP, MSP/MSQ and Hoshin type improvement workshops on flows,

process re-engineering, plus Lean Manufacturing and Lean Office

- Annual surveys, opinion polls and regular visits to customers in order to ascertain and detect their expectations.

Personnel are trained and take part in analyses and actions for continuous improvement of our procedures.

- The motors in this catalogue have been specially designed to measure the impact of their life cycle on the environment. This eco-design approach has resulted in the creation of a "Product Environmental Profile" (references 4592/4950/4951).



Leroy-Somer has entrusted the certification of its expertise to various international organisations.

Certification is granted by independent professional auditors, and recognises the high standards of the **company's quality assurance procedures**. All activities resulting in the final version of the machine have therefore received official certification **ISO 9001: 2008 from the DNV**. Similarly, our environmental approach has enabled us to obtain certification ISO 14001: 2004.

Products for particular applications or those designed to operate in specific environments are also approved or certified by the following organisations: LCIE, DNV, INERIS, EFECTIS, UL, BSRIA, TUV, GOST, which check their technical performance against the various standards or recommendations.



ISO 9001 : 2008



General

General information

Directive and standards relating to motor efficiency

There have been a number of changes to the standards and new standards created in recent years. They mainly concern motor efficiency and their scope includes measurement methods and motor classification.

Regulations are gradually being implemented, both nationally and internationally, in many countries in order to promote the use of high-efficiency motors (Europe, USA, Canada, Brazil, Australia, New Zealand, Korea, China, Israel, etc).

The new generation of Premium efficiency three-phase induction motors responds to changes in the standards as well as the latest demands of system integrators and users.

STANDARD IEC 60034-30-1 (January 2014)

It defines the principle to be adopted and brings global harmonisation to energy efficiency classes for electric motors throughout the world.

Motors concerned

Single-speed, single-phase and three-phase cage induction or permanent magnet motors, on a sinusoidal mains supply.

Sphere of application:

- U_N from 50 to 1000 V
- P_N from 0.12 to 1000 kW
- 2, 4, 6 and 8 poles
- Continuous duty at rated power without exceeding the specified insulation class. Generally known as S1 duty.
- 50 and 60 Hz frequency
- On the mains
- Marked for an ambient temperature between -20°C and +60°C
- Marked for an altitude up to 4000 m

Motors not concerned

- Motors with frequency inverter when the motor cannot be tested without one.
- Brake motors when the brake forms an integral part of the motor and can neither be removed nor supplied by a separate source when being tested.
- Motors which are fully integrated in a machine and cannot be tested separately (such as rotor/stator).

STANDARD FOR MEASURING THE EFFICIENCY OF ELECTRIC MOTORS: IEC 60034-2-1 (September 2007)

It concerns asynchronous induction motors:

- Single-phase and three-phase with power ratings of 1 kW or less. The preferred method is the D.O.L. method.
- Three-phase motors with power ratings above 1 kW. The preferred method is the summation of losses method with the total of additional losses measured.

Notes:

- The standard for efficiency measurement is very similar to the IEEE 112-B method used in North America.
- Since the measurement method is different, this means that for the same motor, the rated value will be different (usually lower) with IEC 60034-2-1 than with IEC 60034-2.

Example of a 22 kW 4P LSES motor:

- according to IEC 60034-2, the efficiency is 92.6%
- according to IEC 60034-2-1, the efficiency is 92.3%

DIRECTIVE 2009/125/CE (21 October 2009)

It establishes a framework for setting the eco-design requirements to be applied to "energy-using products". These products are grouped in lots. Motors come under lot 11 of the eco-design programme, as do pumps, fans and circulating pumps.

DECREE IMPLEMENTING EUROPEAN DIRECTIVE ErP (Energy Related Product) EC/640/2009 - LOT 11 (July 2009) + UE/4/2014 (January 2014)

This is based on standard IEC 60034-30-1 and will define the efficiency classes whose use will be mandatory in the future. It specifies the efficiency levels to be attained for machines sold in the European market and outlines the timetable for their implementation.

Efficiency classes	Efficiency level
IE1	Standard
IE2	High
IE3	Premium
IE4	Super Premium

This standard only defines efficiency classes and their conditions. It is then up to each country to define the efficiency classes and the exact scope of application.

EUROPEAN DIRECTIVE ErP

Motors concerned: 3-phase motors from 0.75 to 375 kW with 2, 4 and 6 poles.

Obligation to place High efficiency or Premium efficiency motors on the market:

- IE2 class from 16 June 2011
- Class IE3* from 1st January 2015 for power ratings from 7.5 to 375 kW
- Class IE3* from 1st January 2017 for power ratings from 0.75 to 375 kW

The European Commission is currently working to define minimum efficiency values for drives.

** or IE2 motor + drive*

Motors not concerned:

- Motors designed to operate when fully submerged in liquid
- Motors which are fully integrated in another product (rotor/stator)
- Motors with duty other than continuous duty
- Motors designed to operate in the following conditions:
 - altitude > 4000 m
 - ambient air temperature > 60°C
 - maximum operating temperature > 400°C
 - ambient air temperature < -30°C or < 0°C for water-cooled motors
 - safety motors conforming to directive ATEX 94/9/EC
 - brake motors
 - onboard motors

IMfinity® 3-phase induction motors - IE2 - IE3 - IE4 - Non IE Efficiency

General

General information

Standards and approvals

LIST OF STANDARDS QUOTED IN THIS DOCUMENT

Motors comply with the standards quoted in this catalogue

Reference		International standards
IEC 60034-1	EN 60034-1	Electrical rotating machines: ratings and operating characteristics
IEC 60034-2		Electrical rotating machines: methods for determining losses and efficiency from tests (additional losses added as a fixed percentage)
IEC 60034-2-1		Electrical rotating machines: methods for determining losses and efficiency from tests (measured additional losses)
IEC 60034-5	EN 60034-5	Electrical rotating machines: classification of degrees of protection provided by casings of rotating machines
IEC 60034-6	EN 60034-6	Electrical rotating machines (except traction): cooling methods
IEC 60034-7	EN 60034-7	Electrical rotating machines (except traction): symbols for mounting positions and assembly layouts
IEC 60034-8		Electrical rotating machines: terminal markings and direction of rotation
IEC 60034-9	EN 60034-9	Electrical rotating machines: noise limits
IEC 60034-12	EN 60034-12	Starting performance of single-speed three-phase cage induction motors for supply voltages up to and including 660 V.
IEC 60034-14	EN 60034-14	Electrical rotating machines: mechanical vibration of certain machines with shaft heights 56 mm and higher. Measurement, evaluation and limits of vibrational intensity
IEC 60034-17		Cage induction motors when fed from converters - Application guide
IEC 60034-30-1		Electrical rotating machines: efficiency classes for single-speed three-phase cage induction motors (IE code)
IEC 60038		IEC standard voltages
IEC 60072-1		Dimensions and power series for electrical rotating machines: designation of casings between 56 and 400 and flanges between 55 and 1080
IEC 60085		Evaluation and thermal classification of electrical insulation
IEC 60721-2-1		Classification of natural environment conditions. Temperature and humidity
IEC 60892		Effects of an imbalance in the voltage system on the characteristics of three-phase squirrel-cage induction motors
IEC 61000-2-10/11 and 2-2		Electromagnetic compatibility (EMC): environment
IEC guide 106		Guidelines on the specification of environmental conditions for the determination of operating characteristics of equipment
ISO 281		Bearings - Basic dynamic loadings and nominal bearing life
ISO 1680	EN 21680	Acoustics - Test code for measuring airborne noise emitted by electrical rotating machines: a method for establishing an expert opinion for free field conditions over a reflective surface
ISO 8821		Mechanical vibration - Balancing. Conventions on shaft keys and related parts
	EN 50102	Degree of protection provided by electrical housings against extreme mechanical impacts
ISO 12944-2		Corrosion protection.

IMfinity® 3-phase induction motors - IE2 - IE3 - IE4 - Non IE Efficiency

General

General information

Standards and approvals

MAIN PRODUCT MARKINGS WORLDWIDE

There are lots of special markings throughout the world. They mainly concern product conformance with current user safety standards in different countries. Some markings or labels only concern energy regulations. The same country can therefore have two markings: one for safety and one for energy.



This marking is mandatory throughout the European Economic Community. It means that the product conforms to all the relevant directives. If the product does not conform to a relevant directive, it cannot be CE rated and cannot therefore bear the **CE** mark.



In **Canada and the United States**: The **CSA** mark accompanied by the letters C and US means that the product is approved for the US and Canadian markets, in accordance with the relevant American and Canadian standards. If a product has characteristics applicable to more than one type of product (eg: electrical equipment incorporating fuel combustion), the mark indicates conformance with all the relevant standards.



This marking only applies to finished products such as complete machines. A motor is just a component and is not therefore affected by this marking.

Note: c CSA us and c UL us mean the same thing but one is delivered by the CSA and the other by the UL.



The **c UL us** mark, which is optional, indicates conformance with Canadian requirements and those of the United States. UL encourages manufacturers distributing products bearing the UL Recognized Component Mark for both countries to use this combined mark.

For Canada at least c UR us or c CSA us is required. Both are also possible.

Components covered by the UL "Recognized Component Mark" programme are designed to be installed in another device, system or final product. They should be installed in the factory, not in the field and it is possible that their performance capability will be restricted and will limit their use. When a complete product or system containing UL Recognized components is assessed, the final product assessment process can be rationalised.



Canada: energy efficiency conformance logo (optional).



USA: energy efficiency conformance logo (optional).



USA and Canada: EISA conformance logo (optional).



This marking is mandatory for the Chinese market. It indicates that the product conforms to the regulations currently in force (safety of users). Concerned electric motors are rated ≤ 1.1 kW.



The EAC mark replaces the GOST mark. It is the equivalent of the CE mark for the European Union market. This new mark covers regulations for Russia, Kazakhstan and Belarus. All products marketed in these three countries must bear this marking.

Other markings concern specific applications, such as ATEX for example.

IMfinity® 3-phase induction motors - IE2 - IE3 - IE4 - Non IE Efficiency

General

General information

Standards and approvals

APPROVALS FOR LEROY-SOMER MOTORS (versions derived from standard CONSTRUCTION)

Country	Initials	Certification No.	Application
CANADA	CSA	LR 57 008 166,631	Standard adapted range (see section "Supply voltage") Complete motors
USA	UL or FJ	E 68554 SA 6704 E 206450	Impregnation systems Stator/rotor assemblies for sealed units Complete motors up to 132 size
FRANCE	LCIE INERIS	Various nos.	Sealing, shocks, safety

For approved special products, see the relevant documents.

INTERNATIONAL AND NATIONAL STANDARD EQUIVALENTS

International reference standards		National standards				
IEC	Title (summary)	FRANCE	GERMANY	U.K.	ITALY	SWITZERLAND
60034-1	Ratings and operating characteristics	NFEN 60034-1 NFC 51-120 NFC 51-200	DIN/VDE 0530	BS 4999	CEI 2.3.VI.	SEV ASE 3009
60034-5	Classification of degrees of protection	NFEN 60034-5	DIN/EN 60034-5	BS EN 60034-5	UNEL B 1781	
60034-6	Cooling methods	NFEN 60034-6	DIN/EN 60034-6	BS EN 60034-6		
60034-7	Mounting arrangements and assembly layouts	NFEN 60034-7	DIN/EN 60034-7	BS EN 60034-7		
60034-8	Terminal markings and direction of rotation	NFC 51 118	DIN/VDE 0530 Teil 8	BS 4999-108		
60034-9	Noise limits	NFEN 60034-9	DIN/EN 60034-9	BS EN 60034-9		
60034-12	Starting characteristics for single-speed motors for supply voltages ≤ 660 V	NFEN 60034-12	DIN/EN 60034-12	BS EN 60034-12		SEV ASE 3009-12
60034-14	Mechanical vibrations of machines with frame size ≥ 56 mm	NFEN 60034-14	DIN/EN 60034-14	BS EN 60034-14		
60072-1	Dimensions and output powers for machines of between 56 and 400 frame size and flanges of between 55 and 1080.	NFC 51 104 NFC 51 105	DIN 748 (~) DIN 42672 DIN 42673 DIN 42631 DIN 42676 DIN 42677	BS 4999		
60085	Evaluation and thermal classification of electrical insulation	NFC 26206	DIN/EN 60085	BS 2757		SEV ASE 3584

Note: DIN 748 tolerances do not conform to IEC 60072-1.

Definition of "Index of Protection" (IP)

INDEXES OF PROTECTION OF ELECTRICAL EQUIPMENT ENCLOSURES

In accordance with IEC 60034-5 - EN 60034-5 (IP) - IEC 62262 (IK)

IP	Tests	Definition	IP	Tests	Definition	IK	Tests	Definition
0		No protection	0		No protection	00		No protection
1	Ø 50 mm	Protected against solid objects larger than 50 mm (e.g. accidental contact with the hand)	1		Protected against water drops falling vertically (condensation)	01	150 g 10 cm	Impact energy: 0.15 J
2	Ø 12 mm	Protected against solid objects larger than 12 mm (e.g. a finger)	2	15°	Protected against water drops falling at up to 15° from the vertical	02	200 g 10 cm	Impact energy: 0.20 J
3	Ø 2.5 mm	Protected against solid objects larger than 2.5 mm (e.g. tools, wires)	3	60°	Protected against rain falling at up to 60° from the vertical	03	250 g 15 cm	Impact energy: 0.37 J
4	Ø 1 mm	Protected against solid objects larger than 1 mm (e.g. thin tools, small wires)	4		Protected against projected water from all directions	04	250 g 20 cm	Impact energy: 0.50 J
5		Protected against dust (no deposits of harmful material)	5		Protected against jets of water from all directions from a hose	05	350 g 20 cm	Impact energy: 0.70 J
6		Protected against any dust penetration	6		Protected against projected water comparable to big waves	06	250 g 40 cm	Impact energy: 1 J
			7	0.15 m	Protected against the effects of immersion between 0.15 and 1 m	07	0.5 kg 40 cm	Impact energy: 2 J
			8	..m	Protected against prolonged effects of immersion under pressure	08	1.25 kg 40 cm	Impact energy: 5 J
						09	2.5 kg 40 cm	Impact energy: 10 J
						10	5 kg 40 cm	Impact energy: 20 J

Example:

Example of an IP 55 machine

IP : Index of Protection

- 5 : Machine protected against dust and accidental contact.
Test result: no dust enters in harmful quantities, no risk of direct contact with rotating parts. The test will last for 2 hours.
- .5 : Machine protected against jets of water from all directions from hoses at 3 m distance with a flow rate of 12.5 l/min at 0.3 bar.
The test will last for 3 minutes.
Test result: no damage from water projected onto the machine.

IMfinity® 3-phase induction motors - IE2 - IE3 - IE4 - Non IE Efficiency

General

Environment

Environmental limitations

NORMAL OPERATING CONDITIONS

ACCORDING TO IEC 60034-1, MOTORS CAN OPERATE IN THE FOLLOWING NORMAL CONDITIONS:

- ambient temperature within the range -16°C to +40°C
- altitude less than 1000 m
- atmospheric pressure: 1050 hPa (mbar) = (750 mm Hg)

POWER CORRECTION FACTOR

For operating conditions outside these limits, apply the power correction coefficient shown in the chart on the right while maintaining the thermal reserve, as a function of the altitude and ambient temperature.

NORMAL STORAGE CONDITIONS

Machines should be stored at an ambient temperature between -16°C and +80°C for aluminium motors, between -40°C and +80°C for cast iron motors, and at a relative humidity of less than 90%. For restarting, see the commissioning manual.

RELATIVE AND ABSOLUTE HUMIDITY

MEASURING THE HUMIDITY:

Humidity is usually measured by the “wet and dry bulb thermometer” method. Absolute humidity, calculated from the readings taken on the two thermometers, can be determined using the chart on the right. The chart also provides relative humidity figures.

To determine the humidity correctly, a good air flow is required for stable readings, and accurate readings must be taken on the thermometers.

During the construction of aluminium motors, the materials of the various components which are in contact with one another are selected so as to minimise deterioration by galvanic effect. The voltages in the metal combinations used (cast iron-steel; cast iron-aluminium; steel-aluminium; steeltin) are too low to cause deterioration.

Correction coefficient table

NB: The output power can only be corrected upwards once the ability of the motor to start the load has been checked.

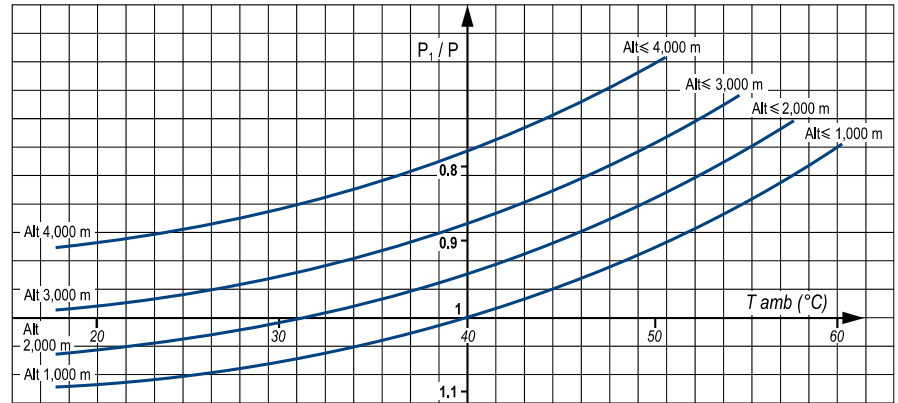

In temperate climates, relative humidity is generally between 50 and 70%. For the relationship between relative humidity and motor impregnation, especially where humidity and temperature are high, see table on next page.

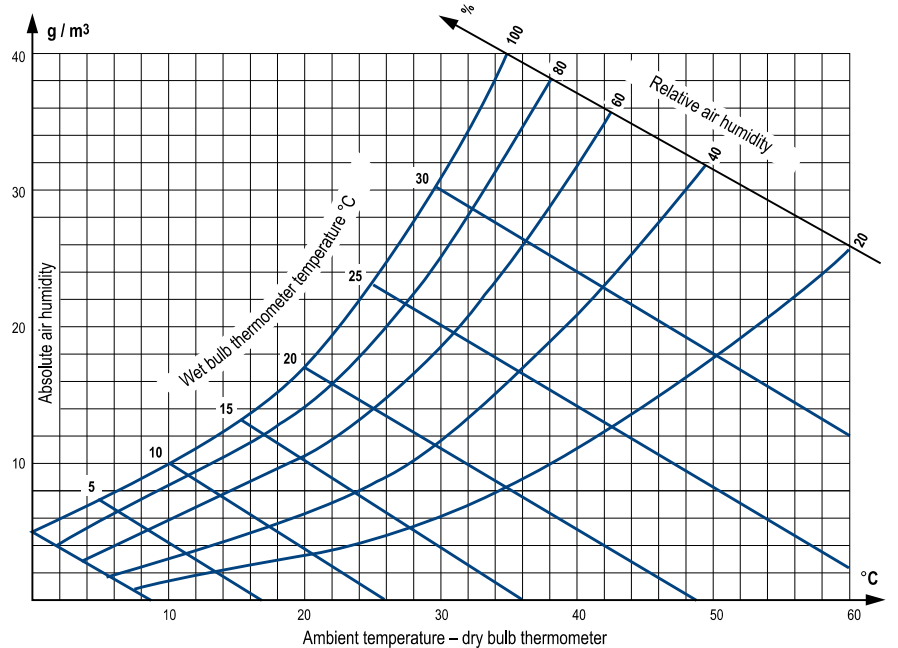

DRAIN HOLES

Holes are provided at the lowest points of the enclosure, depending on the operating position (IM etc) to drain off any moisture that may have accumulated inside during cooling of the machine.

- The holes may be sealed in various ways:
- standard: with plastic plugs
 - on request: with screws, siphon or plastic ventilator

Under certain special conditions, it is advisable to leave the drain holes permanently open (operation in environments with high levels of condensation). Opening the holes periodically should be part of the regular maintenance procedure.

DRIP COVERS

For machines operating outdoors, with the drive shaft downwards, drip covers are recommended. This is an option and should be specified on the order if required.

General

Environment

Impregnation and enhanced protection

NORMAL ATMOSPHERIC PRESSURE (750 MM HG)

The selection table below can be used to find the method of manufacture best suited to particular environments in which temperature and relative humidity show large degrees of variation (see relative and absolute humidity calculation method, on preceding page).

The symbols used refer to permutations of components, materials, impregnation methods and finishes (varnish or paint).

The protection of the winding is generally described by the term "tropicalization".

T: Tropicalization

TC: Complete Tropicalization

For high humidity environments, we recommend that the windings are pre-heated (see next page).

INFLUENCE OF ATMOSPHERIC PRESSURE

As atmospheric pressure decreases, air particles rarefy and the environment becomes increasingly conductive.

- P > 550 mm Hg:



standard impregnation according to previous table - Possible derating or forced ventilation.

- P > 200 mm Hg :

Coating of bearings - Flying leads up to a zone at P ~ 750 mm Hg - Derating to take account of insufficient ventilation - Forced ventilation.

- P < 200 mm Hg: Special manufacture based on specification.

In all cases, these problems should be resolved by a special contract worked out on the basis of a specification.

Ambient temperature	Relative humidity	RH ≤ 95%	RH > 95 % ¹	Influence on construction
θ < - 40 °C		ask for estimate (quotation)	ask for estimate (quotation)	 <p>Increasing derating</p>
- 16 °C to + 50 °C		T Standard	TC Standard	
- 40 °C to + 50 °C ²		T1	TC1	
- 16 °C to + 65 °C ²		T2	TC2	
+ 65 °C to + 90 °C ²		T3	TC3	
θ > + 90 °C		ask for estimate (quotation)	ask for estimate (quotation)	
Plate mark		T	TC	
Influence on construction		 <p>Increased protection of windings</p>		

1. Atmosphere without high levels of condensation

2. For motors with a frame size ≥ 280 mm and IP23 motors with frame size ≥ 315 mm: upon offer

Standard impregnation

General

Environment

Heaters

SPACE HEATERS

Severe climatic conditions, e.g. T amb < -40°C, RH > 95% etc, may require the use of space heaters (fitted to one or two winding end coils) which serve to maintain the average temperature of the motor, provide trouble-free starting, and/or eliminate problems caused by condensation (loss of insulation).

The heater supply wires are brought out to a terminal block in the motor terminal box.

The heaters must be switched off while the motor is running.

D.C. SUPPLY INJECTION HEATING

An alternative to the use of space heaters is to inject direct current into two of the phases wired in series from a D.C. voltage source.

This is easily calculated: if R is the resistance of the windings in series, the D.C. voltage will be given by the equation (Ohm's law):

$$U_{(V)} = \sqrt{P_{(W)} \cdot R_{(\Omega)}}$$

Resistance should be measured with a micro-ohmmeter.

A.C. INJECTION HEATING

A single-phase A.C. voltage (from 10 to 15% of rated voltage), can be used between 2 phases placed in series. This method can be used on the whole motor range.

See the mechanical and electrical options pages for each motor family to find the space heater values.



IMfinity® 3-phase induction motors - IE2 - IE3 - IE4 - Non IE Efficiency

General

Environment

External finish

Surface protection is defined in the ISO 12944 standard. This standard defines the planned lifetime of a paint system until the first major application of maintenance paint. Durability is not a guarantee.

The EN ISO 12944 standard comprises 8 sections. Part 2 covers the classification of the environments.

Leroy-Somer motors are protected with a range of surface finishes.

The surfaces receive appropriate special treatments, as shown below.

PREPARATION OF SURFACES

SURFACE	PARTS	TREATMENT
Cast iron	End shields	Shot blasting + Primer
Steel	Accessories	Phosphatization + Primer
	Terminal boxes - Fan covers	Electrostatic painting or Epoxy powder
Aluminium alloy	Housings - Terminal boxes	Shot blasting
Polymer	Fan covers- Terminal boxes Ventilation grilles	None, but must be free from grease, casting-mould coatings and dust which would affect paint adhesion

CLASSIFICATION OF THE ENVIRONMENTS

Leroy-Somer paint systems according to the categories.

ATMOSPHERIC CORROSIVE CATEGORIES	CORROSIVITY CATEGORY* AS PER ISO 12944-2	Durability class	ISO 6270	ISO 9227	Leroy-Somer system equivalent
			Water condensation nb hours	Salt mist nb hours	
AVERAGE	C3	Limited	48	120	Ia
		Medium	120	240	IIa
		High	240	480	IIb
HIGH	C4	Limited	120	240	-
		Medium	240	480	IIIa
		High	480	720	IIIb**
VERY HIGH (Industry)	C5-I	Limited	240	480	-
		Medium	480	720	Ve**
		High	720	1440	-
VERY HIGH (Marine)	C5-M	Limited	240	480	-
		Medium	480	720	-
		High	720	1440	161b**

Standard for LSES aluminium and PLSES steel motors

Standard for FLSES cast iron motors

* Values given for information only since the substrates vary in nature whereas the standard only takes account of steel substrates.

** Evaluation of the degree of rusting in accordance with ISO 4628 (rusted area between 1 and 0.5%).

Leroy-Somer standard paint colour reference:

RAL 6000

Interference suppression and protection of people

AIRBORNE INTERFERENCE

EMISSION

For standard motors, the housing acts as an electromagnetic screening, reducing electromagnetic emissions measured at 0.25 metres from the motor to approximately 5 gauss (5×10^{-4} T). However, electromagnetic emissions may be noticeably reduced by a special construction of aluminium alloy end shields and a stainless steel shaft.

IMMUNITY

The construction of motor housings (especially finned aluminium alloy frames) isolates external electromagnetic sources to the extent that any field penetrating the casing and magnetic circuit will be too weak to interfere with the operation of the motor.

POWER SUPPLY INTERFERENCE

The use of electronic systems for starting, variable speed control or power supply can create harmonics on the supply lines which may interfere with the operation of machines. These phenomena are taken into account in determining the machine dimensions, which act as quenching chokes in this respect.

The IEC 61000 standard, currently in preparation, will define permissible rejection and immunity rates: only then will machines for general distribution (especially single-phase motors and commutator motors) have to be fitted with suppression systems.

Three-phase squirrel cage machines do not in themselves produce interference of this type. Mains connection equipment (contactors) may, however, need interference protection.

APPLICATION OF DIRECTIVE 2004/108/EC CONCERNING ELECTROMAGNETIC COMPATIBILITY (EMC)

a - for motors only

According to amendment 1 of IEC 60034-1, induction motors are not transmitters and do not produce interference (via carried or airborne signals) and therefore conform inherently to the essential requirements of the EMC directives.

b - for motors supplied by inverters (at fixed or variable frequency)

In this case, the motor is only a sub-assembly of a device which the system builder must ensure conforms to the essential requirements of the EMC directives.

APPLICATION OF LOW VOLTAGE DIRECTIVE 2006/95/CE

All motors are subject to this directive. The main requirements concern the protection of people, animals and property against risks caused by operation of the motors (see the commissioning and maintenance manual for precautions to be taken).

APPLICATION OF MACHINERY DIRECTIVE 2006/42/EC

All motors are designed to be integrated in a device subject to the machinery directive.

CE PRODUCT MARKING

The fact that motors comply with the essential requirements of the Directives is shown by the **CE** mark on their nameplates and/or packaging and documentation.

IMfinity® 3-phase induction motors - IE2 - IE3 - IE4 - Non IE Efficiency

General

Construction



Mounting arrangements

MOUNTINGS AND POSITIONS (IEC STANDARD 60034-7)

Foot mounted motors

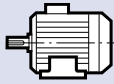
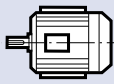
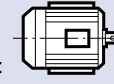
- all frame sizes

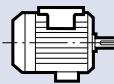
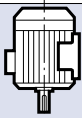
IM 1001 (IM B3) - Horizontal shaft - Feet on floor	
IM 1051 (IM B6) - Horizontal shaft - Wall mounted with feet on left when viewed from drive end	
IM 1061 (IM B7) - Horizontal shaft - Wall mounted with feet on right when viewed from drive end	

IM 1071 (IM B8) - Horizontal shaft - Feet on top	
IM 1011 (IM V5) - Vertical shaft facing down - Feet on wall	
IM 1031 (IM V6) - Vertical shaft facing up - Feet on wall	

(FF) flange mounted motors

- all frame sizes (except IM 3001, which is limited to frame size 225 mm)

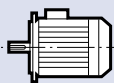
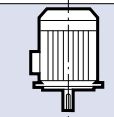
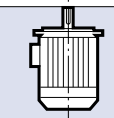
IM 3001 (IM B5) - Horizontal shaft	
IM 3011 (IM V1) - Vertical shaft facing down	
IM 3031 (IM V3) - Vertical shaft facing up	

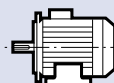
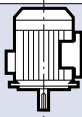
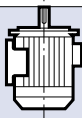
IM 2001 (IM B35) - Horizontal shaft - Feet on floor	
IM 2011 (IM V15) - Vertical shaft facing down - Feet on wall	
IM 2031 (IM V36) - Vertical shaft facing up - Feet on wall	

(FT) face mounted motors

- all frame sizes ≤ 132 mm

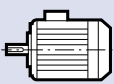
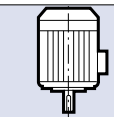
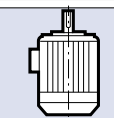
IM 3601 (IM B14) - Horizontal shaft	
IM 3611 (IM V18) - Vertical shaft facing down	
IM 3631 (IM V19) - Vertical shaft facing up	

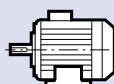
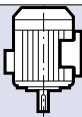
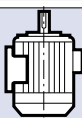
IM 2101 (IM B34) - Horizontal shaft - Feet on floor	
IM 2111 (IM V58) - Vertical shaft facing down - Feet on wall	
IM 2131 (IM V69) - Vertical shaft facing up - Feet on wall	

Motors without drive end shield

Warning: The protection (IP) specified on the IM B9 and IM B15 motor nameplates is provided by the customer when the motor is assembled.

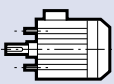
IM 9101 (IM B9) - Threaded tie rods - Horizontal shaft	
---	---

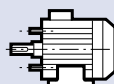
IM 1201 (IM B15) - Foot mounted with threaded tie rods - Horizontal shaft	
--	---

Frame size (mm)	Mounting positions											
	IM 1001	IM 1051	IM 1061	IM 1071	IM 1011	IM 1031	IM 3001	IM 3011	IM 3031	IM 2001	IM 2011	IM 2031
≤ 200	●	●	●	●	●	●	●	●	●	●	●	●
225 and 250	●	●	●	●	●	●	■	●	●	●	●	●
≥ 280	●	■	■	■	■	■	■	●	●	●	●	■

● : possible positions.

■ : please consult Leroy-Somer specifying the coupling method and the axial and radial loads if applicable

IMfinity® 3-phase induction motors - IE2 - IE3 - IE4 - Non IE Efficiency

General

Construction

Mains connection

TERMINAL BOX

Placed as standard on the top of the motor near the drive end, it is IP 55 protection and fitted with threaded plugs or a removable undrilled support plate.

The standard position of the plug is on the right, seen from the drive end but, owing to the symmetrical construction of the box, it can usually be placed in any of the 4 directions, as shown in the table below:

If required, the terminal box may be fitted in a different position (on the left or right as seen from the drive end, and at the DE or NDE of the motor housing).

Positions of the terminal box in relation to the drive end (motor in IM 1001 position)

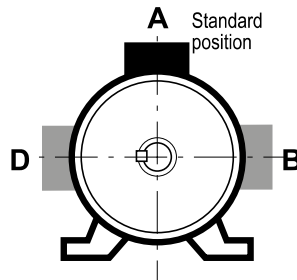

Positions of the plug in relation to the drive end

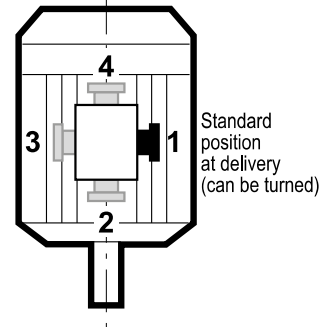

FLYING LEADS

According to specification, motors can be supplied with flying leads using single-core cables (as an option, the cables can be protected by a sheath) or multicore cables.

Please state cable characteristics (cross-section, length, number of conductors), connection method (flying leads or on a terminal block) and the drill hole position.

Terminal box position	A	B	D
LSES	●	■	■
FLSES 80 to 225 SR/MR	●	-	-
FLSES 225M to 450	●	■	■
PLSES	●	■	■

- : standard
- : please consult Leroy-Somer
- : not available

Cable gland position	1	2*	3	4
LSES - FLSES - PLSES 80 to 315	◆	★	★	★
PLSES 315 LG/MGU/VLG/VLGU PLSES 355/400	◆	-	★	-

* not recommended (impossible on (FF) flange mounted motors and on the FLSES 355LK/400/450)

- ◆ : standard
- ★ : possible by simply turning round the terminal box
- : not available

WIRING DIAGRAMS

All standard motors are supplied with a wiring diagram in the terminal box. The diagrams normally used are shown opposite.

On the following pages are outline diagrams with internal and external connections.

EARTH TERMINAL

This is situated inside the terminal box. Consisting of a threaded stud with a hexagonal nut, it is used to connect cables with cross-sections at least as large as the cross-section of the phase conductors.

It is indicated by the sign: \perp in the terminal box moulding.

On request, a second earth terminal can be fitted on one of the feet or on one of the cooling fins.

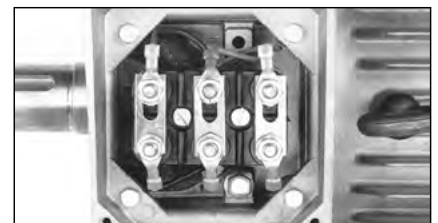
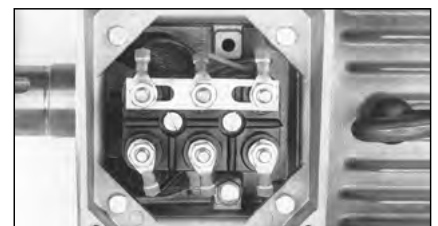
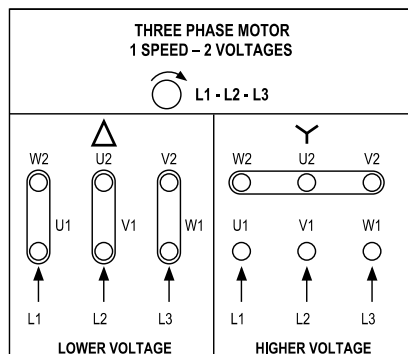

General

Construction

Radial loads

PERMISSIBLE RADIAL LOAD ON THE MAIN SHAFT EXTENSION

In pulley and belt couplings, the drive shaft carrying the pulley is subjected to a radial force F_{pr} applied at a distance X (mm) from the shoulder of the shaft extension (length E).

Radial force acting on the drive shaft: F_{pr}

The radial force F_{pr} expressed in daN applied to the drive shaft is found by the formula.

$$F_{pr} = 1.91 \cdot 10^6 \frac{P_N \cdot k}{D \cdot N_N} \pm P_P$$

where:

P_N = rated motor power (kW)

D = external diameter of the drive pulley (mm)

N_N = rated motor speed (min^{-1})

k = factor depending on the type of transmission

P_P = weight of the pulley (daN)

The weight of the pulley is positive when it acts in the same direction as the tension force in the belt (and negative when it acts in the opposite direction).

Range of values for factor k (*)

- toothed belts: $k = 1$ to 1.5

- V-belts: $k = 2$ to 2.5

- flat belts

• with tensioner: $k = 2.5$ to 3

• without tensioner: $k = 3$ to 4

(*) A more accurate figure for factor k can be obtained from the transmission suppliers.

Permissible radial force on the drive shaft:

The charts on the following pages indicate, for each type of motor, the radial force FR at a distance X permissible on the drive end shaft extension, for a bearing life L_{10h} of 25,000 hours.

Note: For frame sizes ≥ 315 M, the selection charts are applicable for a motor installed with the shaft horizontal.

Change in bearing life depending on the radial load factor.

For a radial load F_{pr} ($F_{pr} \neq FR$), applied at distance X , the bearing life L_{10h} changes, as a rough estimate, in the ratio k_R ($k_R = F_{pr}/FR$) as shown in the chart below, for standard fitting arrangements.

If the load factor k_R is greater than 1.05, you should consult our technical department, stating mounting position and direction of force before opting for a special fitting arrangement.

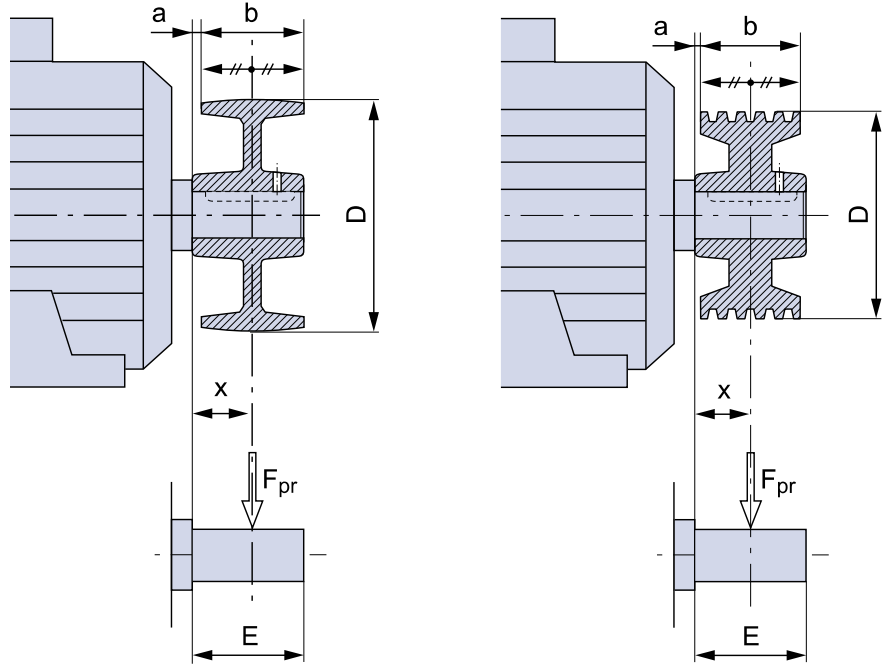

$$\left\{ \begin{array}{l} x = a + \frac{b}{2} \\ \text{where} \\ x \leq E \end{array} \right.$$

$$\left\{ \begin{array}{l} x = a + \frac{b}{2} \\ \text{where} \\ x \leq E \end{array} \right.$$

Change in bearing life L_{10h} depending on the radial load factor k_R for standard fitting arrangements.

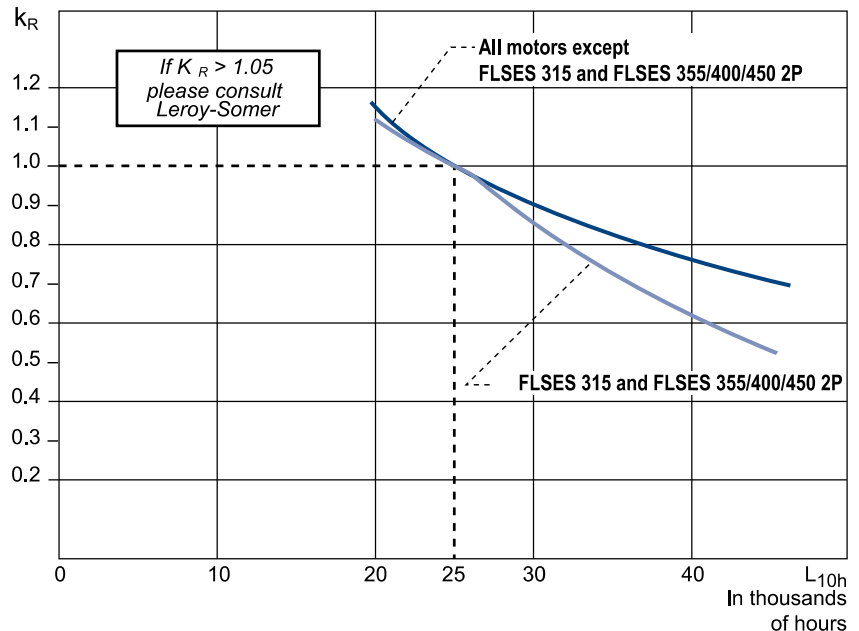

IMfinity® 3-phase induction motors - IE2 - IE3 - IE4 - Non IE Efficiency

General

Construction

Cooling

Designation for the IC (International Cooling) coded cooling method in the IEC 60034-6 standard.

The standard allows for two designations (general formula and simplified formula) as shown in the example opposite.

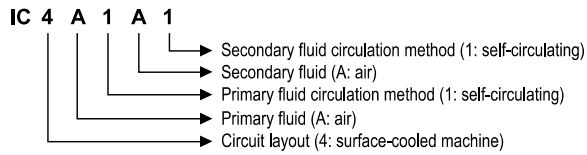

NB: The letter A may be omitted if this will not lead to confusion. This contracted formula becomes the simplified formula.
Simplified form: **IC 411**.

Circuit layout

Characteristic number	Abbreviated designation	Description
0(1)	Free circulation	The coolant enters and leaves the machine freely. It is taken from and returned to the fluid round the machine.
1(1)	Machine with one intake pipe	The coolant is taken up elsewhere than from the fluid round the machine, brought into the machine through an intake pipe and emptied into the fluid round the machine.
2(1)	Machine with one outlet pipe	The coolant is taken up from the fluid round the machine, brought away from the machine by an outlet pipe and does not go back into the fluid round the machine.
3(1)	Machine with two pipes (intake and outlet)	The coolant is taken up elsewhere than from the fluid round the machine, brought to the machine through an intake pipe, then taken away from the machine through an outlet pipe and does not go back into the fluid round the machine.
4	Surface cooled machine using the fluid round the machine	The primary coolant circulates in a closed circuit, transferring its heat to a secondary coolant (the one surrounding the machine) through the machine casing. The casing surface is either smooth or finned to improve heat transmission.
5(2)	Built-in heat exchanger (using the surrounding environment)	The primary coolant circulates in a closed circuit, transferring its heat to a secondary coolant (the one surrounding the machine) in an integral heat exchanger inside the machine.
6(2)	Machine-mounted heat exchanger (using the surrounding environment)	The primary coolant circulates in a closed circuit, transferring its heat to a secondary coolant (the one surrounding the machine) in a heat exchanger that forms an independent unit, mounted on the machine.
7(2)	Built-in heat exchanger (not using the surrounding environment)	The primary coolant circulates in a closed circuit, transferring its heat to a secondary coolant (which is not the one round the machine) in an integral heat exchanger inside the machine.
8(2)	Machine-mounted heat exchanger (not using the surrounding environment)	The primary coolant circulates in a closed circuit, transferring its heat to a secondary coolant (which is not the one round the machine) in a heat exchanger that forms an independent unit, mounted on the machine.
9(2)(3)	Separate heat exchanger (using the surrounding environment or not)	The primary coolant circulates in a closed circuit, transferring its heat to the secondary fluid in a heat exchanger that forms an independent unit, away from the machine.

Coolant

Characteristic letter	Type of fluid
A	Air
F	Freon
H	Hydrogen
N	Nitrogen
C	Carbon dioxide
W	Water
U	Oil
S	Any other fluid (must be identified separately)
Y	The fluid has not yet been selected (used temporarily)

Method of circulation

Characteristic number	Designation abbreviated	Description
0	Free circulation	The circulation of the coolant is due only to differences in temperature. Ventilation caused by the rotor is negligible.
1	Self-circulating	The circulation of the coolant depends on the rotational speed of the main machine, and is caused by the action of the rotor alone, or a device mounted directly on it.
2, 3, 4		Not yet defined.
5(4)	Built-in and independent device	The coolant is circulated by a built-in device which is powered independently of the rotational speed of the main machine.
6(4)	Independent device mounted on the machine	The coolant is circulated by a device mounted on the machine which is powered independently of the rotational speed of the main machine.
7(4)	Entirely separate independent device or using the pressure of the coolant circulation system	The coolant is circulated by a separate electrical or mechanical device, independent and not mounted on the machine, or by the pressure in the coolant circulation system.
8(4)	Relative displacement	The circulation of the coolant is produced by the relative movement between the machine and the coolant, either by displacement of the machine in relation to the coolant, or by the flow of the surrounding coolant.
9	All other devices	The coolant is circulated using a method other than those defined above: it must be described in full.

(1) Filters or labyrinth seals for dust removal or noise protection can be fitted inside the casing or in the ducting. The first characteristic numbers 0 to 3 also apply to machines in which the coolant is taken up at the outlet of a water-cooler designed to lower the temperature of the ambient air or recirculated through a water-cooler so as not to increase the ambient temperature.

(2) The nature of the heat exchanger elements is not specified (smooth or finned tubes, corrugated surfaces, etc).

(3) A separate heat exchanger can be installed near to or at a distance from the machine. A secondary gas coolant may be the surrounding environment or not.

(4) Use of such a device does not exclude the ventilating action of the rotor or the existence of an additional fan mounted directly on the rotor.

MOTOR VENTILATION

In compliance with IEC 60034-6, the motors in this catalogue are cooled using method IC 411, ie. "surface-cooled machine using the ambient air circulating round the machine".

Cooling is achieved by a fan mounted at the non-drive end of the motor, inside a fan cover which acts as a safety guard (check according to IEC 600 34-5). The fan draws the air through the grille in the cover and blows it along the housing fins, giving an identical heat balance in either direction of rotation (except for LSES 2-pole motors of frame size 315 mm).

NB: Obstruction, even accidental, of the fan cover grille (grille clogged or placed against a wall) seriously impairs motor cooling.

We recommend a minimum distance of 1/3 of the frame size between the end of the cover and any possible obstacle (wall, machine, etc).

Variable speed motor cooling (ventilation)

Special precautions need to be taken when standard induction motors are being used with variable speed, powered by an inverter or voltage controller. During prolonged operation at low speed, cooling efficiency is greatly diminished. It is therefore advisable to

install a forced ventilation unit that will produce a constant flow of air independently of the motor speed.

In prolonged operation at high speed, the fan may make excessive noise. It is again advisable to install a forced ventilation unit.

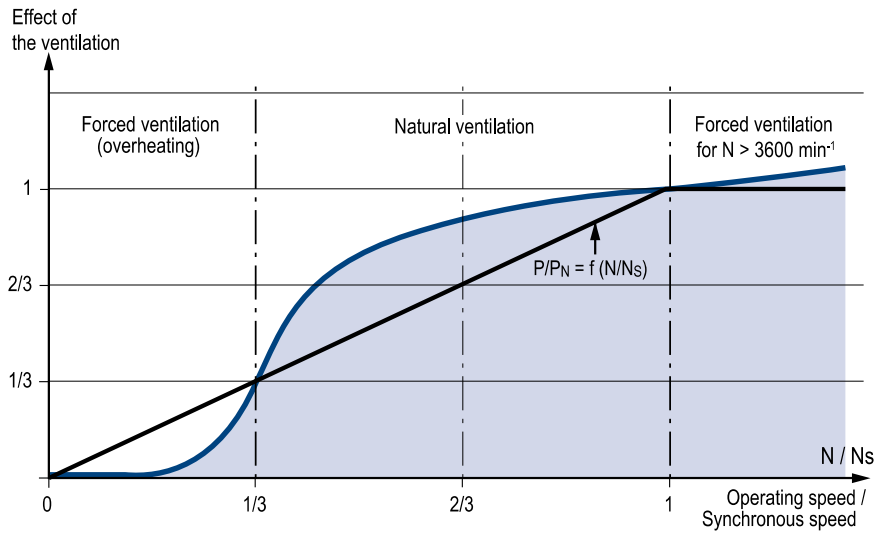

NON-VENTILATED APPLICATIONS IN CONTINUOUS OPERATION

Motors can be supplied without fans. Dimensions will depend on the application.

IC 418 COOLING SYSTEM

If they are placed in the air flow from a fan, these motors are capable of supplying their rated power if the speed of the air between the housing fins and the overall flow rate of the air between the fins comply with the data in the table below.

Type LSES/FLSES	2 poles		4 poles		6 poles	
	flow rate m³/h	speed m/s	flow rate m³/h	speed m/s	flow rate m³/h	speed m/s
80	120	7.5	60	4	40	2.5
90	200	11.5	75	5.5	60	3.5
100	300	15	130	7.5	95	5
112	460	18	200	9	140	6
132	570	21	300	10.5	220	7
160	1000	21	600	12.5	420	9
180	1200	21	900	16	600	10
200	1800	23	1200	16	750	10
225	2000	24	1500	18	1700	13
250	3000	25	2600	20	1700	13
280	3000	25	2600	20	2000	15
315	5000	25	2600	20	2000	15
355	5200	25	2800	20	2200	15
400	5500	25	3000	20	2600	15
450	6000	25	3200	20	2600	15

These air flows are valid for normal operating conditions as described in the "Environmental limitations" section.

IMfinity® 3-phase induction motors - IE2 - IE3 - IE4 - Non IE Efficiency

General

Construction

Cooling for LSES/FLSES/PLSES motors

STANDARD CODES

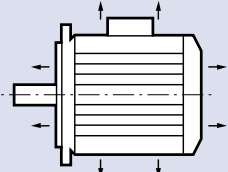
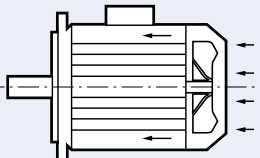
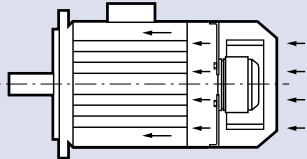
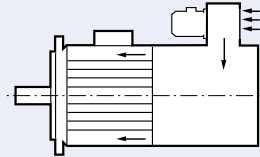
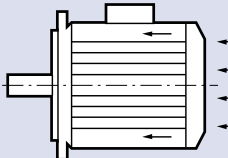
IC 410	Enclosed machine, surface-cooled by natural convection and radiation. No external fan.	
IC 411	Enclosed machine. Smooth or finned ventilated casing. External shaft-mounted fan.	
IC 416 A*	Enclosed machine. Smooth or finned enclosed casing. External motorized axial (A) fan supplied with the machine.	
IC 416 R*	Enclosed machine. Smooth or finned enclosed casing. External motorized radial (R) fan supplied with the machine.	
IC 418	Enclosed machine. Smooth or finned casing. No external fan. Ventilation provided by air flow coming from the driven system.	

* Features not within manufacturer's standard range.

APPLICATION OF COOLING SYSTEMS TO THE LEROY-SOMER RANGE

Type LSES/FLSES	IC 410 IC 418	IC 411	IC 416 A	IC 416 R
80	●	■	●	◆
≥ 90	●	■	●	●

- : standard construction
- : possible (ask for estimate)
- ◆ : not available

Other cooling systems may be fitted, such as liquid cooling.

IMfinity® 3-phase induction motors - IE2 - IE3 - IE4 - Non IE Efficiency

General

Construction

Motor connections

SINGLE SPEED MOTORS

Voltages and connections	Internal wiring diagrams	Winding outline diagrams	External connection diagrams	
			D.O.L. starting	Y / Δ starting
Single voltage type motors (3 TERMINALS)				
- Voltage: U - Connection: Y internal Eg: 400 V/Y				
- Voltage: U - Connection: internal Δ e.g. 400 V / Δ				
Dual-voltage motors with Y, Δ connections (6 TERMINALS)				
- Voltage: U - Connection: Δ (at lower voltage) e.g. 230 V / Δ				
- Voltage: U√3 - Connection: Y (at higher voltage) Eg: 400 V/Y				
Dual-voltage motors with series-parallel connections (9 TERMINALS)				
- Voltage: U - Connection: YY (at lower voltage) Eg: 230 V/YY				
- Voltage: 2 U - Connection: Y (series-star at higher voltage) Eg: 460 V/Y				

DEFINITIONS

LOAD RATINGS

Static load rating Co:

This is the load for which permanent deformation at point of contact between a bearing race and the ball (or roller) with the heaviest load reaches 0.01% of the diameter of the ball (or roller).

Dynamic load rating C:

This is the load (constant in intensity and direction) for which the nominal lifetime of the bearing will reach 1 million revolutions.

The static load rating Co and dynamic load rating C are obtained for each bearing by following the method in ISO 281.

LIFETIME

The lifetime of a bearing is the number of revolutions (or number of operating hours at a constant speed) that the bearing can accomplish before the first signs of fatigue (spalling) begin to appear on a ring, ball or roller.

Nominal lifetime L10h

According to the ISO recommendations, the nominal lifetime is the length of time achieved or exceeded by 90% of apparently identical bearings operating under the conditions specified by the manufacturer.

Note: The majority of bearings last much longer than the nominal lifetime; the average lifetime achieved or exceeded by 50% of bearings is around 5 times longer than the nominal lifetime.

DETERMINATION OF NOMINAL LIFETIME

Constant load and speed of rotation

The nominal lifetime of a bearing expressed in operating hours L10h, the dynamic load rating C expressed in daN and the applied loads (radial load Fr and axial load Fa) are related by the following equation:

$$L_{10h} = \frac{1000000}{60 \cdot N} \cdot \left(\frac{C}{P}\right)^p$$

where N = speed of rotation (rpm)

P (P = X Fr + Y Fa): equivalent dynamic load (Fr, Fa, P in daN)

p: exponent which is a function of the contact between the races and balls (or rollers)

p = 3 for ball bearings

p = 10/3 for roller bearings

The formulae that give Equivalent Dynamic Load (values of factors X and Y) for different types of bearing may be obtained from the various manufacturers.

Variable load and speed of rotation

For bearings with periodically variable load and speed, the nominal lifetime is established using the equation:

$$L_{10h} = \frac{1000000}{60 \cdot N_m} \cdot \left(\frac{C}{P_m}\right)^p$$

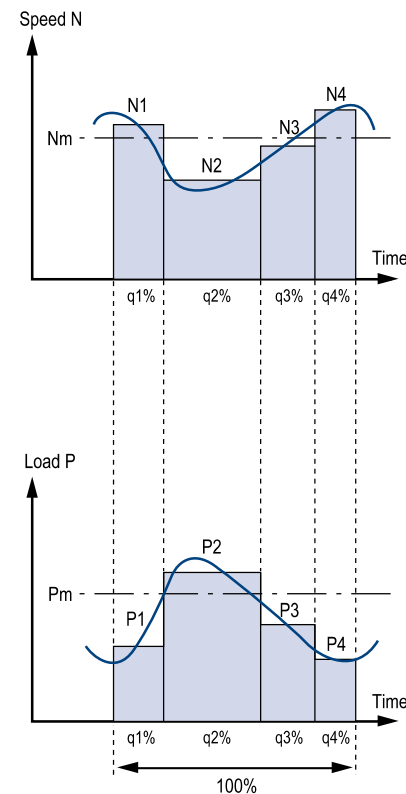

N_m: average speed of rotation

$$N_m = N_1 \cdot \frac{q_1}{100} + N_2 \cdot \frac{q_2}{100} + \dots (\text{min}^{-1})$$

P_m: average equivalent dynamic load

$$P_m = P \sqrt{P_1^p \cdot \left(\frac{N_1}{N_m}\right) \cdot \frac{q_1}{100} + P_2^p \cdot \left(\frac{N_2}{N_m}\right) \cdot \frac{q_2}{100} + \dots (\text{daN})}$$

with q1, q2, etc as a %

Nominal lifetime L10h is applicable to bearings made of bearing steel and normal operating conditions (lubricating film present, no contamination, correctly fitted, etc).

Situations and data differing from these conditions will lead to either a reduction or an increase in lifetime compared to the nominal lifetime.

Corrected nominal lifetime

If the ISO recommendations (DIN ISO 281) are used, improvements to bearing steel, manufacturing processes and the effects of operating conditions may be integrated in the nominal lifetime calculation.

The theoretical pre-fatigue lifetime L_{nah} is thus calculated using the formula:

$$L_{nah} = a_1 a_2 a_3 L_{10h}$$

where:

a₁: failure probability factor.

a₂: factor for the characteristics and tempering of the steel.

a₃: factor for the operating conditions (lubricant quality, temperature, speed of rotation, etc).

Lubrication and maintenance of bearings

ROLE OF THE LUBRICANT

The principal role of the lubricant is to avoid direct contact between the metal parts in motion: balls or rollers, slip-rings, cages, etc. It also protects the bearing against wear and corrosion.

The quantity of lubricant needed by a bearing is normally quite small. There should be enough to provide good lubrication without undesirable overheating. As well as lubrication itself and the operating temperature, the amount of lubricant should be judged by considerations such as sealing and heat dissipation.

The lubricating power of a grease or an oil lessens with time owing to mechanical constraints and straight forward ageing. Used or contaminated lubricants should therefore be replaced or topped up with new lubricant at regular intervals.

Bearings can be lubricated with grease, oil or, in certain cases, with a solid lubricant.

GREASING

A lubricating grease can be defined as a product of semi-fluid consistency obtained by the dispersion of a thickening agent in a lubricating fluid and which may contain several additives to give it particular properties.

Composition of a grease
Base oil: 85 to 97%
Thickener: 3 to 15 %
Additives: 0 to 12 %

THE BASE OIL LUBRICATES

The oil making up the grease **is of prime importance**. It is the oil that lubricates the moving parts by coating them with a protective film which prevents direct contact. The thickness of the lubricating film is directly linked to the viscosity of the oil, and the viscosity itself depends on temperature. The two main types used to make grease are mineral oils and synthetic oils. Mineral oils are suitable for normal applications in a range of temperatures from -30°C to +150°C.

Synthetic oils have the advantage of being effective in severe conditions (extreme variations of temperature, harsh chemical environments, etc).

THE THICKENER GIVES THE GREASE CONSISTENCY

The more thickener a grease contains, the "harder" it will be. Grease consistency varies with the temperature. In falling temperatures, the grease hardens progressively, and the opposite happens when temperatures rise.

The consistency of a grease can be quantified using the NLGI (National Lubricating Grease Institute) classification. There are 9 NLGI grades, from 000 for the softest greases up to 6 for the hardest. Consistency is expressed by the depth to which a cone may be driven into a grease maintained at 25°C.

If we only consider the chemical nature of the thickener, lubricating greases fall into three major categories:

- **Conventional greases with a metallic soap base** (calcium, sodium, aluminium, lithium). Lithium soaps have several advantages over other metallic soaps: a high melting point (180° to 200°), good mechanical stability and good water resistant properties.

- **Greases with a complex soap base.** The main advantage of this type of soap is a very high melting point (over 250°C).

- **Soapless greases.** The thickener is an inorganic compound, such as clay. Their main property is the absence of a melting point, which makes them practically non-liquefying.

ADDITIVES IMPROVE SOME GREASE PROPERTIES

Additives fall into two types, depending on whether or not they are soluble in the base oil.

The most common insoluble additives - graphite, molybdenum disulphide, talc, mica, etc, improve the friction characteristics between metal surfaces. They are therefore used in applications where heavy pressure occurs.

The soluble additives are the same as those used in lubricating oils: antioxidants, anti-rust agents, etc.

LUBRICATION TYPE

The bearings are lubricated with a polyurea soap-based grease.

General Operation

Duty cycle - Definitions

DUTY CYCLES

(IEC 60034-1)

The typical duty cycles are described below:

1 - Continuous duty - Type S1

Operation at constant load of sufficient duration for thermal equilibrium to be reached (see figure 1).

2 - Short-time duty - Type S2

Operation at constant load during a given time, less than that required for thermal equilibrium to be reached, followed by a rest and de-energized period of sufficient duration to re-establish machine temperatures within 2 K of the coolant (see figure 2).

3 - Intermittent periodic duty - Type S3

A sequence of identical duty cycles, each consisting of a period of operation at constant load and a rest and deenergized period (see figure 3). Here, the cycle is such that the starting current does not significantly affect the temperature rise.

4 - Intermittent periodic duty with starting - Type S4

A sequence of identical duty cycles, each consisting of a significant starting period, a period of operation at constant load and a rest and de-energized period (see figure 4).

5 - Intermittent periodic duty with electrical braking, Type S5.

A sequence of periodic duty cycles, each consisting of a starting period, a period of operation at constant load, a period of rapid electrical braking and a rest and de-energized period (see figure 5).

6 - Periodic continuous duty with intermittent load, Type S6.

A sequence of identical duty cycles, each consisting of a period of operation at constant load and a period of operation at no load. There is no rest and deenergized period (see figure 6).

7 - Periodic continuous duty with electrical braking, Type S7.

A sequence of identical duty cycles, each consisting of a starting period, a period of operation at constant load and a period of electrical braking. There is no rest and de-energized period (see figure 7).

8 - Periodic continuous duty with related changes of load and speed - Type S8

A sequence of identical duty cycles, each consisting of a period of operation at constant load corresponding to a predetermined rotation speed, followed by one or more periods of operation at other constant loads corresponding to different rotation speeds (in induction motors, this can be done by changing the number of poles). There is no rest and de-energized period (see figure 8).

9 - Duty with non-periodic variations in load and speed - Type S9

This is a duty in which the load and speed generally vary non-periodically within the permissible operating range. This duty frequently includes applied overloads which may be much higher than the full load or loads (see figure 9).

Note - For this type of duty, the appropriate full load values must be used as the basis for calculating overload.

10 - Operation at discrete constant loads - Type S10

This duty consists of a maximum of 4 discrete load values (or equivalent loads), each value being applied for sufficient time for the machine to reach thermal equilibrium. The minimum load during a load cycle may be zero (no-load operation or rest and de-energized period) (see figure 10).

NB: only S1 duty type is affected by IEC 60034-30-1

Fig. 1. - Continuous duty, Type S1.

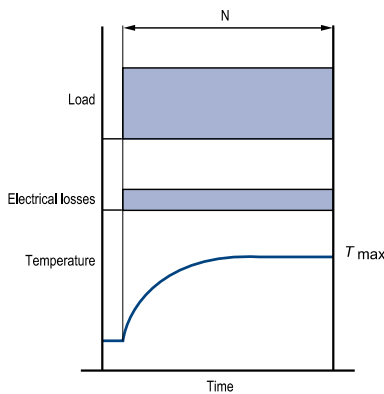

N = operation at constant load
 T_{max} = maximum temperature attained

Fig. 2. - Short-time duty, Type S2.

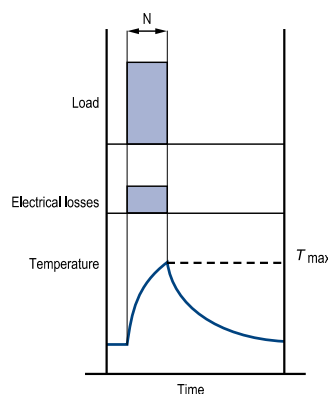

N = operation at constant load
 T_{max} = maximum temperature attained

Fig. 3. - Intermittent periodic duty, Type S3.

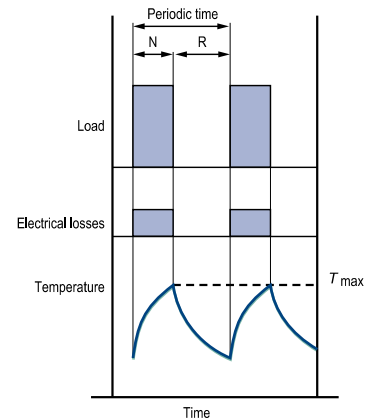

N = operation at constant load
 R = rest
 T_{max} = maximum temperature attained
 Running factor (%) = $\frac{N}{N + R} \cdot 100$

**General
Operation**

Duty cycle - Definitions

Fig. 4. - Intermittent periodic duty with starting, Type S4.

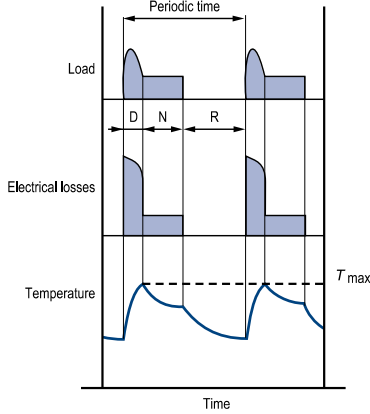

D = starting
 N = operation at constant load
 R = rest
 T_{max} = maximum temperature attained during cycle
 Operating factor (%) = $\frac{D + N}{N + R + D} \cdot 100$

Fig. 5. - Intermittent periodic duty with electrical braking, Type S5.

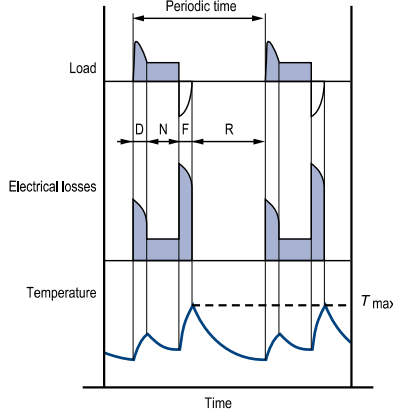

D = starting
 N = operation at constant load
 F = electrical braking
 R = rest
 T_{max} = maximum temperature attained during cycle
 Operating factor (%) = $\frac{D + N + F}{D + N + F + R} \cdot 100$

Fig. 6. - Periodic continuous duty with intermittent load, Type S6.

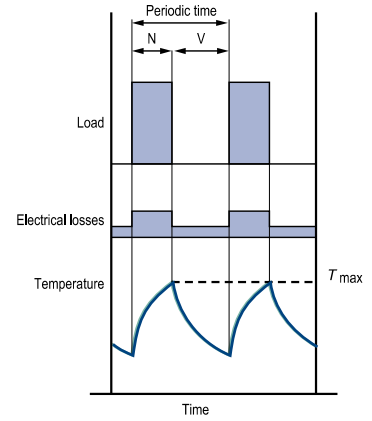

N = operation at constant load
 V = no-load operation
 T_{max} = maximum temperature attained during cycle
 Operating factor (%) = $\frac{N}{N + V} \cdot 100$

Fig. 7. - Periodic continuous duty with electrical braking, Type S7.

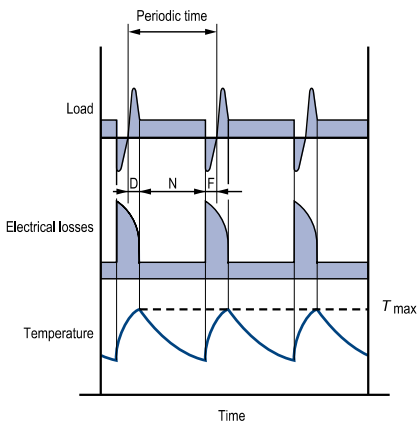

D = starting
 N = operation at constant load
 F = electrical braking
 T_{max} = maximum temperature attained during cycle
 Operating factor = 1

Fig. 8. - Periodic continuous duty with related changes of load and speed, Type S8.

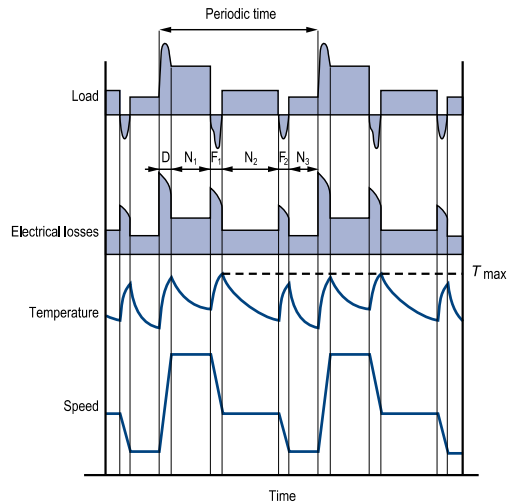

$F_1 F_2$ = electric braking
 D = starting
 $N_1 N_2 N_3$ = operation at constant loads
 T_{max} = maximum temperature attained during cycle
 Operating factor = $\frac{D + N_1}{D + N_1 + F_1 + N_2 + F_2 + N_3} \cdot 100\%$
 $\frac{F_1 + N_2}{D + N_1 + F_1 + N_2 + F_2 + N_3} \cdot 100\%$
 $\frac{F_2 + N_3}{D + N_1 + F_1 + N_2 + F_2 + N_3} \cdot 100\%$

Fig. 9. - Duty with non-periodic variations in load and speed, Type S9.

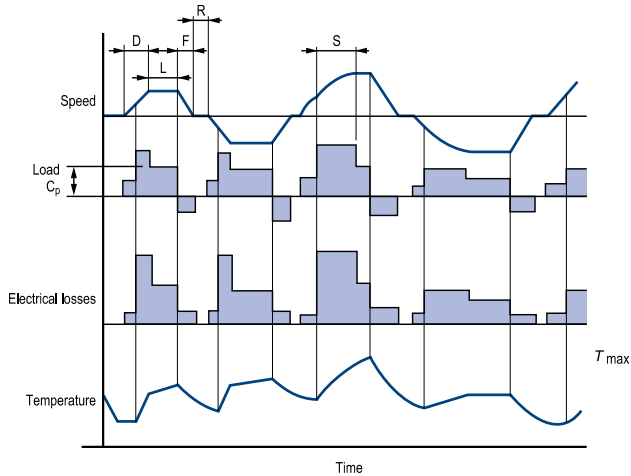

- D = starting
- L = operation at variable loads
- F = electrical braking
- R = rest
- S = operation at overload
- C_p = full load
- T_{max} = maximum temperature attained

Fig. 10 - Duty at discrete constant loads, Type S10.

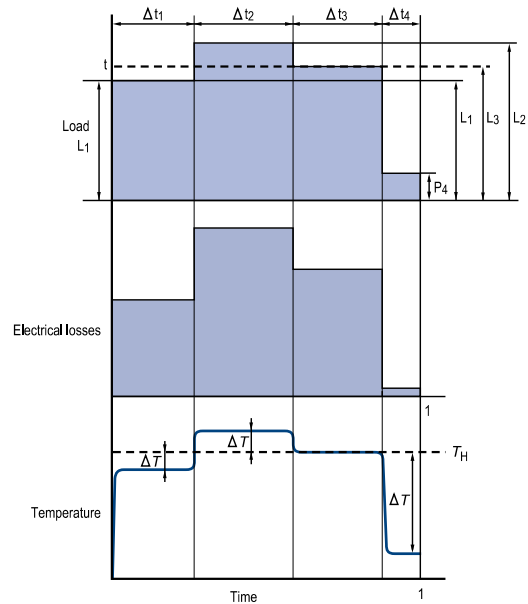

- L = load
- N = rated power for type S1 duty
- $p = p / \frac{L}{N} = \text{reduced load}$
- t = time
- T_p = total cycle time
- t_i = discrete period within a cycle
- $\Delta t_i = t_i / T_p = \text{relative duration of period within a cycle}$
- P_u = electrical losses
- H_N = temperature at rated power for type S1 duty
- $\Delta H_i = \text{increase or decrease in temperature rise during the } i\text{th period of the cycle}$

Power is determined according to duty cycle. See "Operation" section, § "Power - Torque - Efficiency - Power Factor (Cos φ)".

For duty ratings between S3 and S8 inclusive, the default cycle is 10 minutes unless otherwise indicated.

IMfinity® 3-phase induction motors - IE2 - IE3 - IE4 - Non IE Efficiency

General

Operation

Supply voltage

REGULATIONS AND STANDARDS

The IEC 60038 standard gives the European reference voltage as 230/400V three-phase and 230 V single-phase, with a tolerance of $\pm 10\%$.

The tolerances usually permitted for power supply sources are indicated below:

- Maximum line drop between customer delivery point and customer usage point: 4%.

- Variation in frequency around the rated frequency:

- continuous operation: $\pm 1\%$

- transient state: $\pm 2\%$

- Three-phase mains phase voltage imbalance:

- Zero-sequence component and/or negative phase sequence component compared to positive phase sequence component: $< 2\%$

The motors in this catalogue are designed for use on the European power supply of 230/400 V $\pm 10\%$ - 50 Hz.

All other voltages and frequencies are available on request.

- For motors of frame size ≤ 160 mm, maximum operating voltage: 700V

- For motors of frame size ≥ 180 mm, maximum operating voltage: 1000 V

EFFECTS ON MOTOR PERFORMANCE

VOLTAGE RANGE

The characteristics of motors will of course vary with a corresponding variation in voltage of $\pm 10\%$ around the rated value.

An approximation of these variations is given in the table opposite.

	Voltage variation as a %				
	UN-10%	UN-5%	UN	UN+5%	UN+10%
Torque curve	0.81	0.90	1	1.10	1.21
Slip	1.23	1.11	1	0.91	0.83
Rated current	1.10	1.05	1	0.98	0.98
Rated efficiency	0.97	0.98	1	1.00	0.98
Rated power factor (cos ϕ)	1.03	1.02	1	0.97	0.94
Starting current	0.90	0.95	1	1.05	1.10
Nominal temperature rise	1.18	1.05*	1	1*	1.10
P (Watt) no-load	0.85	0.92	1	1.12	1.25
Q (reactive VA) no-load	0.81	0.9	1	1.1	1.21

* According to standard IEC 60034-1, the additional temperature rise must not exceed 10 K within $\pm 5\%$ of UN.

IMfinity® 3-phase induction motors - IE2 - IE3 - IE4 - Non IE Efficiency

General Operation

Supply voltage

SIMULTANEOUS VARIATION OF VOLTAGE AND FREQUENCY

Within the tolerances defined in guide 106 of the IEC (see § D2.1), machine input and performance are unaffected if the variations are of the same polarity and the voltage/frequency ratio U/f remains constant.

If this is not the case, variations in performance are significant and require the machine specification to be changed.

Variation in main motor parameters (approx.) within the limits defined in IEC Guide 106.

U/f	P_u	M	N	$\cos \varphi$	Efficiency
Constant	$P_u \frac{f}{f'}$	M	$N \frac{f}{f'}$	$\cos \varphi$ unchanged	Efficiency unchanged
Variable	$P_u \left(\frac{u'/u}{f'/f}\right)^2$	$M \left(\frac{u'/u}{f'/f}\right)^2$	$N \frac{f}{f'}$	Dependent on the machine saturation state	

M = minimum and maximum values of starting torque.

USE OF 400V - 50 HZ MOTORS ON 460V - 60 HZ SUPPLIES

For a rated power at 60 Hz equal to the rated power at 50 Hz, the main characteristics are modified according to the following variations:

- Efficiency increases by 0.5 - 1.5%
- Power factor decreases by 0.5 to 1.5%
- Rated current decreases by 0 to 5%
- IS/IN increases by around 10%
- Slip and rated torque MN, MD/MN, MM/MN remain more or less constant.

Comment:

For the North American markets, a different type of construction is needed to comply with the regulatory requirements.

UUSE ON SUPPLIES WITH U' VOLTAGES different from the voltages in the characteristics tables

In this case, the machine windings should be adjusted. As a result, only the current values will be changed and become:

$$I' = I_{400V} \times \frac{400}{U'}$$

PHASE VOLTAGE IMBALANCE

The phase imbalance for voltage is calculated as follows:

$$\text{Phase voltage imbalance as a \%} = 100 \times \frac{\text{maximum difference in voltage compared to the average voltage value}}{\text{average voltage value}}$$

The effect on motor performance is summarized in the table opposite.

When this imbalance is known before the motor is purchased, it is advisable, in order to establish the type of motor

required, to apply the derating specified in standard IEC 60892, illustrated on the graph opposite.

Percentage imbalance	0	2	3.5	5
Stator current	100	101	104	107.5
Increase in losses as a %	0	4	12.5	25
Temperature rise	1	1.05	1.14	1.28

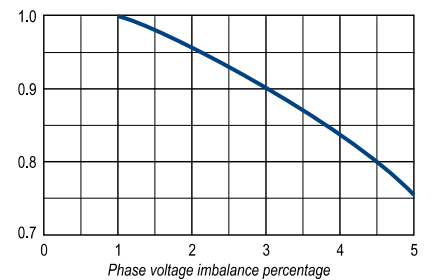

PHRASE CURRENT IMBALANCE

Voltage imbalances induce current imbalances. Natural lack of symmetry due to manufacture also induces current imbalances.

The chart opposite shows the ratios in which the negative phase component is equal to 5% (and 3%) of the positive phase components in three-phase current supplies without zero components (neutral absent or not connected).

Inside the curve, the negative phase component is lower than 5% (and 3%).

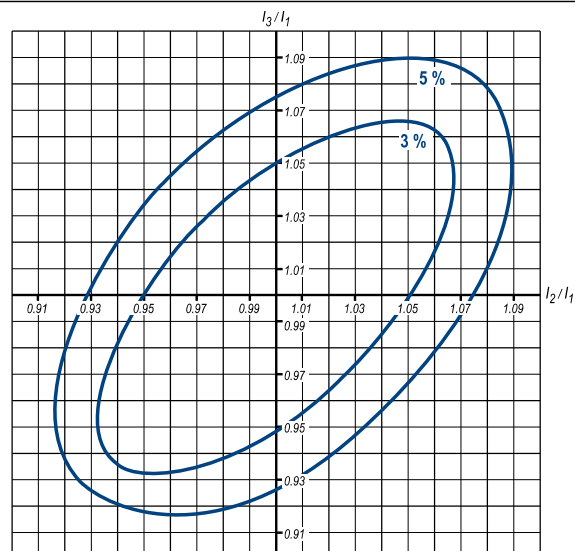

General Operation

Insulation class - Temperature rise and thermal reserve

INSULATION CLASS

The machines in this catalogue have been designed with a class F insulation system for the windings.

Class F allows for temperature rises of 105 K (measured by the resistance variation method) and maximum temperatures at the hot spots in the machine of 155°C (Ref. IEC 60085 and IEC 60034-1).

Complete impregnation with tropicalized varnish of thermal class 180°C gives protection against attacks from the environment, such as: 90% relative humidity, interference, etc.

For special constructions, the winding is class H and impregnated with special varnishes which enable it to operate in conditions of high temperatures with relative air humidity of up to 100%.

The insulation of the windings is monitored in two ways:

a - Dielectric inspection which involves checking the leakage current, at an applied voltage of (2U + 1000) V, in conditions complying with standard IEC 60034-1 (systematic test).

b - Monitoring the insulation resistance between the windings and between the windings and the earth (sampling test) at a D.C. voltage of 500 V or 1000 V.

TEMPERATURE RISE AND THERMAL RESERVE

Leroy-Somer motors are built to have a maximum winding temperature rise of 80 K under normal operating conditions (ambient temperature 40°C, altitude below 1000 m, rated voltage and frequency, rated load).

The result is a thermal reserve linked to the following factors:

- A difference of 25 K between the nominal temperature rise (Un, Fn, Pn) and the permissible temperature rise (105 K) for class F insulation.

- A difference of 10°C minimum at the voltage limits.

In IEC 60034-1 and 60034-2, temperature rise ($\Delta\theta$), is calculated using the winding resistance variation method, with the formula:

$$\Delta T = \frac{R_2 - R_1}{R_1} (235 + T_1) + (T_1 - T_2)$$

R_1 : cold resistance measured at ambient temperature T_1

R_2 : stabilized hot resistance measured at ambient temperature T_2

235: coefficient for a copper winding (for an aluminium winding, the coefficient is 225)

Temperature rise (ΔT^*) and maximum temperatures at hot spots (T_{max}) for insulation classes (IEC 60034-1).

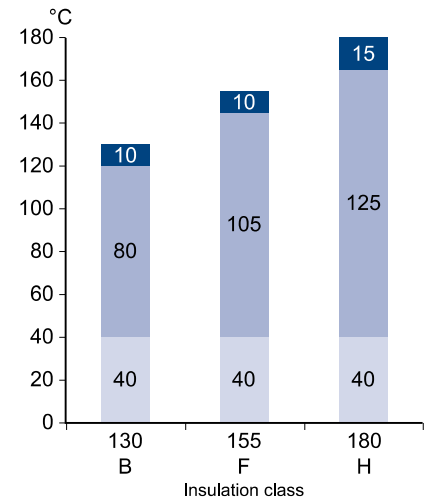

■ Temperature rise at hot spots T_{max}
 ■ Temperature rise
 ■ Ambient temperature



General

Operation

Starting times and starting current

PERMISSIBLE STARTING TIMES AND LOCKED ROTOR TIMES

The calculated starting times must remain within the limits of the graph opposite which defines maximum starting times in relation to the current surge.

Three successive cold starts and two consecutive hot starts are allowed with return to stop between each start.

Permissible motor starting time as a function of the ratio I_d/I_n .

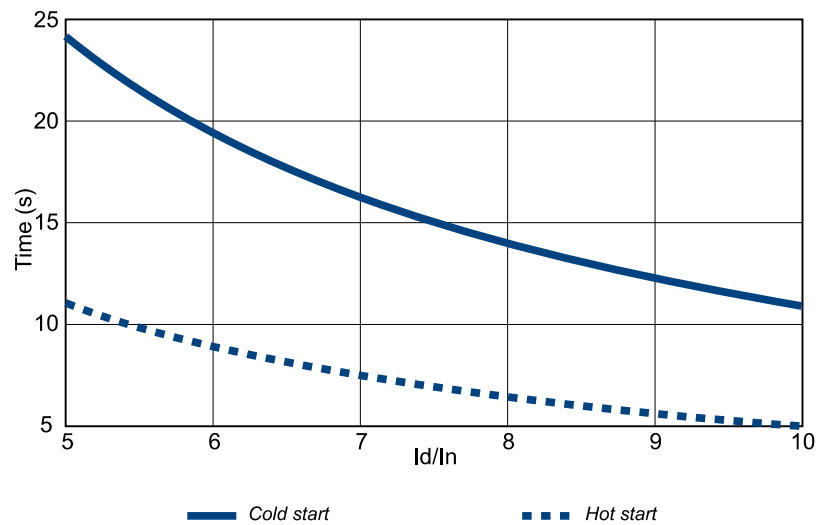

Note: For IP55 motors with frame size ≥ 355 LD, 2 successive cold starts and 1 hot start are allowed (after thermal stabilisation at rated power). A stop of at least 15 minutes must be observed between each successive start.



IMfinity® 3-phase induction motors - IE2 - IE3 - IE4 - Non IE Efficiency

General Operation

Power - Torque - Efficiency - Power Factor (Cos φ)

DEFINITIONS

The output power (Pu) at the motor shaft is linked to the torque (M) by the equation:

$$P_u = M \cdot \omega$$

where Pu in W, M in N.m, ω in rad/s and where ω is expressed as a function of the speed of rotation in rpm by the equation:

$$\omega = 2\pi \cdot N / 60$$

The active power (P) drawn from the

mains is expressed as a function of the apparent power (S) and the reactive power (Q) by the equation:

$$S = \sqrt{P^2 + Q^2}$$

(S in VA, P in W and Q in VAR)

The power P is linked to the output power Pu by the equation:

$$P = \frac{P_u}{\eta}$$

where η is the efficiency of the machine. The output power Pu at the motor shaft is expressed as a function of the phase-to-phase mains voltage (U in Volts), of the line current absorbed (I in Amps) by the equation:

$$P_u = U \cdot I \cdot \sqrt{3} \cdot \cos \varphi \cdot \eta$$

where cos φ is the power factor found from the ratio:

$$\cos \varphi = \frac{P}{S}$$

EFFICIENCY

In accordance with the agreements signed at the Rio and Buenos Aires international conferences, **the new generation of motors with aluminium or cast iron frame** has been designed to improve efficiency in order to reduce atmospheric pollution (carbon dioxide). The improved efficiency of low voltage industrial motors (representing around 50% of installed power in industry) has had a large impact on energy consumption.

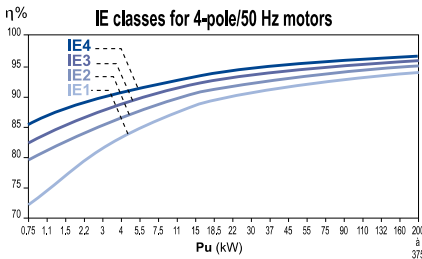

Advantages of improvement in efficiency:

Motor characteristics	Effects on the motor	Customer benefits
Increase in efficiency and in power factor	-	Lower operating costs Longer service life (x2 or 3) Better return on investment
Noise reduction	-	Improved working conditions
Vibration reduction	-	Quiet operation and longer service life of equipment being driven
Temperature reduction	Longer service life of fragile components (insulation system components, greased bearings)	Reduced number of operating incidents and reduced maintenance costs
	Increased capability of instantaneous or extended overloads	Wider field of applications (voltages, altitude, ambient temperature, etc)

INFLUENCE OF LOAD ON EFFICIENCY AND COS φ

See the selection data.

Overrating motors in a number of applications causes them to operate at about 3/4 load, resulting in optimum motor efficiency.

General

Operation

Power - Torque - Efficiency - Power Factor (Cos φ)

RATED POWER P_N IN RELATION TO DUTY CYCLE

GENERAL RULE FOR STANDARD MOTORS

$$P_n = \sqrt{\frac{n \times t_d \times [(I_D/I_n \times P)^2 + (3600 - n \times t_d)P^2_u \times f_{dm}]}{3600}}$$

Iterative calculation where:

- t_d(s) starting time achieved with motor rated P_(w)
- n number of (equivalent) starts per hour
- f_{dm} (OF) Operating factor (decimal)
- I_D/I_n current demand for motor rated P
- P_u (w) motor output power during the duty cycle using OF (in decimal), operating factor
- P_(w) motor rated power selected for the calculation

Note: n and OF are defined in section D4.6.2

Sp = specification

S1	OF = 1 ; n ≤ 6
S2	n = 1 operating life determined by specification (Sp)
S3	OF according to Sp; n ~ 0 (no effect of starting on temperature rise)
S4	OF according to Sp; n according to Sp; t _d , P _u , P according to Sp (replace n with 4n in the above formula)
S5	OF according to Sp; n = n starts + 3 n brakings = 4 n ; t _d , P _u , P as per CdC (replace n with 4n in the above formula)
S6	$P = \sqrt{\frac{\sum^n_i (P^2_i \cdot t_i)}{\sum^n_i t_i}}$
S7	same formula as S5 but OF = 1
S8	at high speed, same formula as in S1 at low speed, same formula as in S5
S9	S8 duty formula after complete description of cycle with OF on each speed
S10	same formula as S6

In addition, see the warning regarding precautions to be taken. Variations in voltage and/or frequency greater than standard should also be taken into account. The application should also be taken into account (general at constant torque, centrifugal at quadratic torque, etc).

DETERMINATION OF THE POWER IN INTERMITTENT DUTY CYCLES FOR ADAPTED MOTORS

RMS POWER IN INTERMITTENT DUTY

This is the rated power absorbed by the driven machine, usually defined by the manufacturer.

If the power absorbed by the machine varies during a cycle, the rms power P is calculated using the equation:

$$P = \sqrt{\frac{\sum^n_i (P^2_i \cdot t_i)}{\sum^n_i t_i}} = \sqrt{\frac{P^2_1 \cdot t_1 + P^2_2 \cdot t_2 + \dots + P^2_n \cdot t_n}{t_1 + t_2 + \dots + t_n}}$$

if, during the working time the absorbed power is:

- P1 for period t1
- P2 for period t2

Pn for period tn

Power values lower than 0.5 PN are replaced by 0.5 PN in the calculation of rms power P (no-load operation is a special case).

Additionally, it is also necessary to check that for a particular motor of power PN:

- the actual starting time is at most equal to 5 seconds
- the maximum output of the cycle does not exceed twice the rated output power P
- there is still sufficient accelerating torque during the starting period

Load factor (LF)

Expressed as a percentage, this is the ratio of the period of operating time with a load during the cycle to the total powered-up time during the cycle.

Operating factor (OF)

Expressed as a percentage, this is the ratio of the motor powered-up time during the cycle to the total cycle time, provided that the total cycle time is less than 10 minutes.

Starting class

Class: n = nD + k.nF + k'.ni

nD: number of complete starts per hour

nF: number of electrical braking operations per hour

“Electrical braking” means any braking directly involving the stator winding or the rotor winding:

- Regenerative braking (with frequency drive, multipole motor, etc).
- Reverse-current braking (the most commonly used)
- D.C. injection braking

ni: number of pulses (incomplete starts up to a third of maximum speed) per hour

k and k' are constants determined as follows:

	k	k'
Cage induction motors	3	0.5

- Reversing the direction of rotation involves braking (usually electrical) and starting.
- Braking with Leroy-Somer electro-mechanical brakes, as with any other brakes that are independent of the motor, does not constitute electrical braking in the sense described above.

General

Operation

Power - Torque - Efficiency - Power Factor (Cos φ)

CALCULATING DERATING

- Input criteria (load)
 - rms power during the cycle = P
 - Moment of inertia related to the speed of the motor: J_e
 - Operating factor = OF
 - Class of starts per hour = n
 - Resistive torque during starting = M_r

- Selection in catalogue
 - Motor rated power = PN
 - Starting current I_d , $\cos\phi_D$
 - Moment of rotor inertia J_r
 - Average starting torque M_{mot}
 - Efficiency at PN (η_{PN}) and at P (η_P)

Calculations

- Starting time:

$$t_d = \frac{\pi}{30} \cdot N \cdot \frac{(J_e + J_r)}{M_{mot} - M_r}$$

- Cumulative starting time per hour: $n \times t_d$

- Energy to be dissipated per hour during starts = sum of the energy dissipated in the rotor (= inertia acceleration energy) and the energy dissipated in the stator during the cumulative starting time per hour:

$$E_d = \frac{1}{2} (J_e + J_r) \left(\frac{\pi \cdot N}{30} \right)^2 \times n + n \times t_d \sqrt{3} U_d \cos\phi_d$$

- Energy to be dissipated during operation

$$E_f = P \cdot (1 - \eta_P) \cdot [(OF) \times 3600 - n \times t_d]$$

- Energy that the motor can dissipate at rated power with the Operating Factor for Intermittent Duty.

$$E_m = (OF) \cdot 3600 \cdot PN(1 - \eta_{PN})$$

- (The heat dissipated when the motor is at rest can be ignored).

Dimensioning is correct if the following relationship is verified =

$$E_m \geq E_d + E_f$$

If the sum of $E_d + E_f$ is lower than 0.75 E_m , check whether a motor with the next lowest power rating would be more suitable.

EQUIVALENT THERMAL CONSTANT

The equivalent thermal constant enables the machine cooling time to be predetermined.

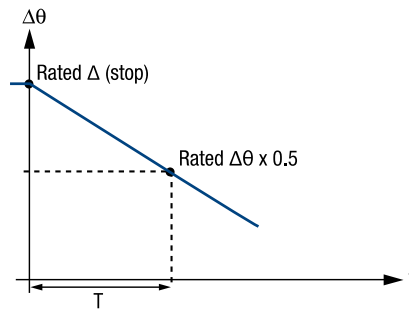

$$\text{Thermal constant} = \frac{T}{\ln 2} = 1.44 T$$

Cooling curve $\Delta\theta = f(t)$
where:

$\Delta\theta$ = temperature rise in S1 duty

T = time taken to go from the nominal temperature rise to half its value

t = time

ln = natural logarithm

TRANSIENT OVERLOAD AFTER OPERATING IN TYPE S1 DUTY CYCLE

At rated voltage and frequency, the motors can withstand an overload of:
1.20 for an OF = 50 %
1.40 for an OF = 10 %

However, it is necessary to ensure that the maximum torque is much greater than 1.5 times the rated torque corresponding to the overload.

IMfinity® 3-phase induction motors - IE2 - IE3 - IE4 - Non IE Efficiency

General Operation

Use with speed drive

As of 1st January 2015, European regulations require IE3 motors or IE2 motors + drive to be released onto the market.

The motors in this catalogue comply with regulation 640/2009, and its modifications, in the ErP directive. For better selection, use and adjustment of the drive parameters, IE2 motors, as defined in the following pages, benefit from a dual nameplate* which means equally good performance can be obtained on a mains supply (non- EU market) as on a drive (EU market).

It should also be noted that the regulation requires information to be included on the nameplate stating that a variable speed drive must be used with a class IE2 motor*.

* See example of nameplate in the Identification section.



CEMEP (the European Committee of Manufacturers of Electrical Machines and Power Electronics) decided to create a label to highlight the conformance of motors manufactured by its members with European regulations, thus ensuring the conformance of products released onto the market with the implementing regulation in the ErP directive.

The Emerson range of drives is extremely well adapted to all the most demanding constraints of the market.



For applications which require an encoder and/or forced ventilation unit, refer to the LSMV range (catalogue ref. 4981) which is specially designed for variable speed.



IMfinity® 3-phase induction motors - IE2 - IE3 - IE4 - Non IE Efficiency

General

Operation

Use with speed drive

APPLICATIONS AND CHOICE OF SOLUTIONS

In principle, there are three typical types of load. It is essential to determine the speed range and the application torque (or power) in order to select the drive system:

CENTRIFUGAL MACHINES

The torque varies as the square of the speed (or cube of the power). The torque required for acceleration is low (about 20% of rated torque). The starting torque is low.

- Sizing: depends on the power or torque at maximum speed
- Drive selected for normal duty

Typical applications: ventilation, pumping, ...

APPLICATIONS WITH CONSTANT TORQUE

The torque remains constant throughout the speed range. The torque required for acceleration may be high, depending on the machine (higher than the rated torque).

- Sizing: depends on the torque required over the entire speed range
- Drive selected for heavy duty

Typical machines: extruders, crushers, gantries, presses, ...

APPLICATIONS WITH CONSTANT POWER

The torque decreases as the speed increases. The torque required for acceleration is no more than the rated torque. The starting torque is at its maximum.

- Sizing: depends on the torque required at minimum speed and the range of operating speeds.
- Drive selected for heavy duty

- An encoder feedback is advisable for improved regulation

Typical machines: winders, machine tool spindles, ...

4 QUADRANTS MACHINES

These applications have a torque/speed operating type as described opposite, but the load becomes a driving load in certain stages of the cycle.

- Sizing: see above depending on the load.
- In the case of repetitive braking, install a reinforced insulation system (RIS).
- Drive selection: to dissipate the power from a driving load, it is possible to use a braking resistor, or to send power back to the grid. In the latter case, a regenerative or 4-quadrant drive should be used.

Typical machines: centrifuges, travelling cranes, presses, machine tool spindles, etc

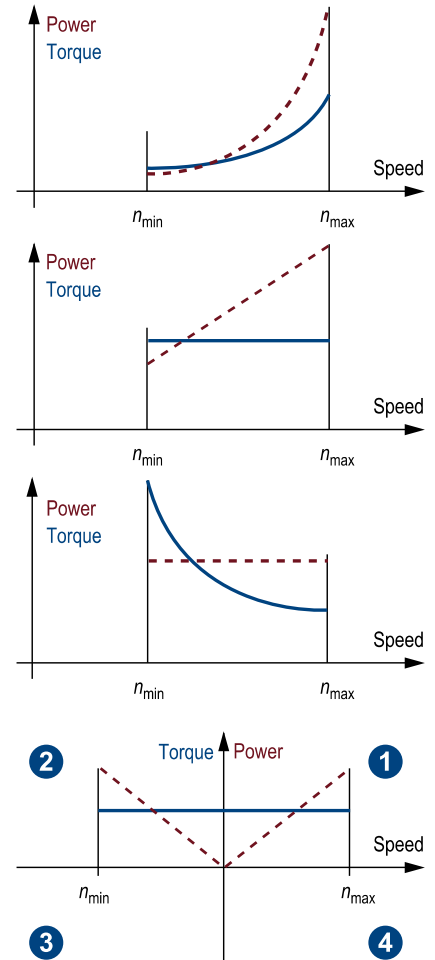

CHOICE OF INVERTER/ MOTOR COMBINATION

The curve below expresses the output torque of a 50 Hz motor (2, 4 or 6 poles) supplied by a drive.

For a frequency inverter with power P_N operating at constant power P within a determined range of speeds, it is possible to optimise the choice of motor and its number of poles to give a maximum amount of torque.

Example: the Unidrive M400-034-00056A-3.5 T drive can supply the following motors:
 LSES 90 - 2 p - 2.2 kW - 7.1 N.m
 LSES 100 - 4 p - 2.2 kW - 14.6 N.m
 LSES 112 - 6 p - 2.2 kW - 21.9 N.m

The choice of the motor and inverter combination will therefore depend on the application.

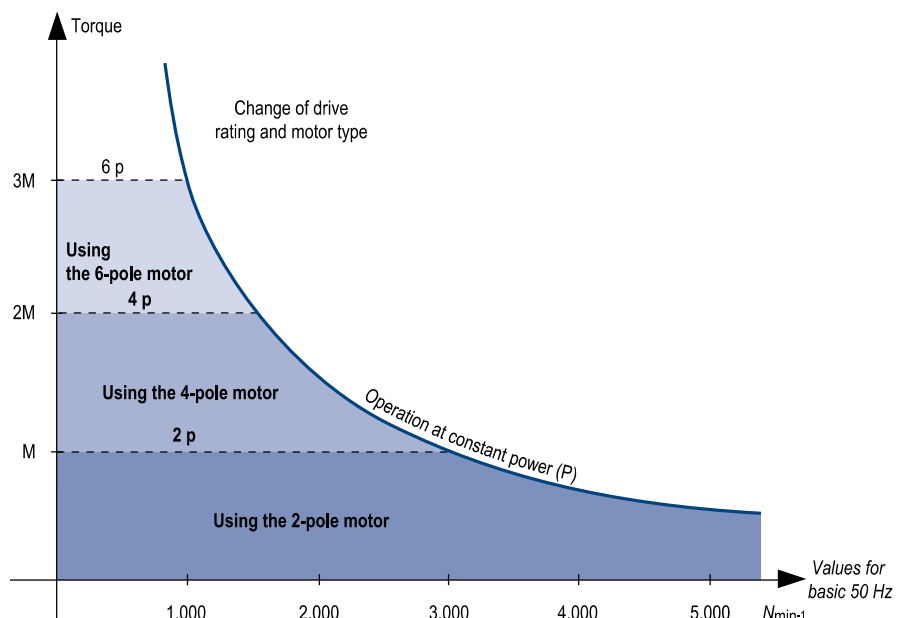

IMfinity® 3-phase induction motors - IE2 - IE3 - IE4 - Non IE Efficiency

General

Operation

Use with speed drive

USING THE MOTOR AT CONSTANT TORQUE FROM 0 to 87 HZ

Using motors with a Δ connection in conjunction with a frequency inverter increases the constant torque range from 50 to 87 Hz, which can increase the power by the same ratio.

The size of the frequency inverter is determined by the current value in 230 V and programmed with a voltage/frequency ratio of 400 V 87 Hz.

Example of selection with 4 poles:

- For constant torque of 195 Nm from 750 to 2600 min^{-1} :
- > selection: 30 kW 4P LSES motor + 100 A drive

Example of selection with 2 poles:

- For constant power of 4 kW from 3000 to 5200 min^{-1} :
- > selection: 3 kW 2P LSES motor + 11 A drive

CAUTION: Max. mechanical speed by frame size to be complied with.

Characteristics of motors on drives
230 V Δ connection 400 V 50 Hz supply

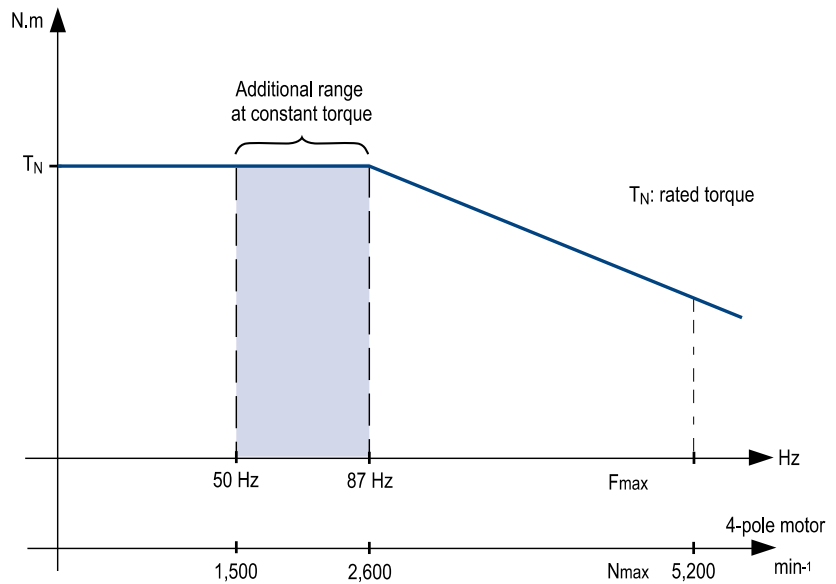
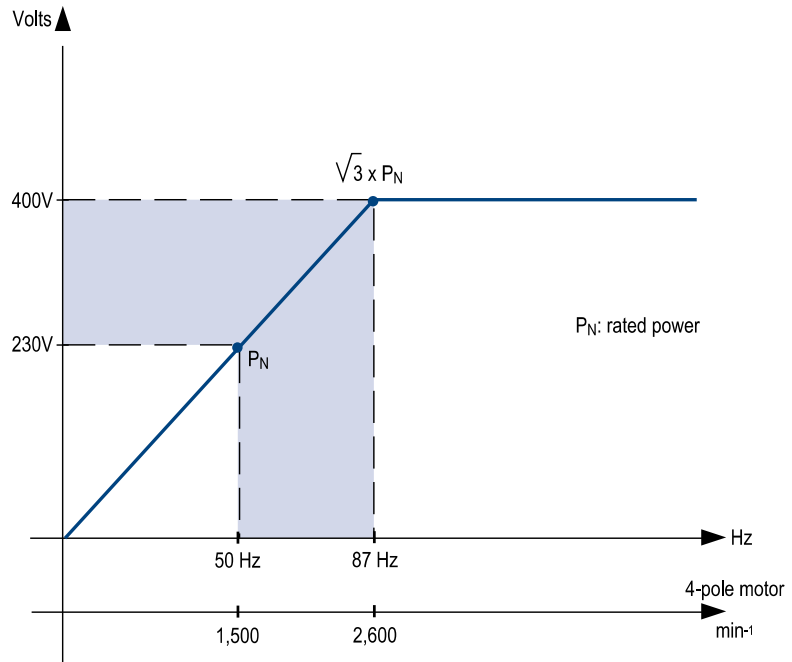

The motors in this catalog are equipped with PTC sensors for frame size ≥ 160 mm

MOTORS USED WITH VARIABLE SPEED DRIVE

GENERAL

Drive control by a frequency inverter can in fact result in an increase in the machine temperature rise, due to a significantly lower supply voltage than on the mains, additional losses related to the wave form produced by the drive (PWM) and the reduction in speed of the cooling fan. Standard IEC 60034-17 describes numerous good practices for all types of electric motor, however since this is LEROY-SOMER's area of specialist expertise, we describe the best ways to deal with variable speed in the section below.

DERATING THE POWER WHEN THE LSES, FLSES AND PLSES RANGES ARE USED AT VARIABLE SPEED

Reminder: Leroy-Somer recommends the use of PTC sensors, monitored by the drive, to protect the motor.

The choice of temperature class B for the mains power supply means that LSES, FLSES or PLSES motors can be used on a drive without derating the power in centrifugal applications. In this case, the temperature class will change from B to F, ie. between 80 and 105 K.

In constant torque applications which can operate below the rated frequency and to avoid derating the power, it may prove necessary to use a forced ventilation unit, depending on the operating cycle.

Note 1: The thermal reserve, a Leroy-Somer special feature, should be used to keep the motor in its temperature class. However in certain cases, the temperature class will change from B to F, ie. between 80 k and 105 k.

Note 2: To avoid changes in frame size due to derating within the standard ranges, Leroy-Somer has developed a range of LSMV adapted motors with standardized dimensions.

General

Operation

Use with speed drive

ADAPTATION OF MOTORS

A motor is always characterised by the following parameters, which depend on the design:

- temperature class
- voltage range
- frequency range
- thermal reserve

CHANGES IN MOTOR PERFORMANCE

When power is supplied by a drive, changes are observed in the above parameters due to certain phenomena:

- Voltage drops in the drive components
- Current increase in proportion with the decrease in voltage
- Difference in motor power supply according to the type of control (flux vector or U/F)

The main consequence is an increase in the motor current resulting in increased copper losses and therefore a higher temperature rise in the winding (even at 50 Hz).

Reducing the speed leads to a reduction in air flow and hence a reduction in cooling efficiency, and as a result the motor temperature rise will increase again. Conversely, in prolonged operation at high speed, the fan may make excessive noise, and it is advisable to install a forced ventilation system.

Above the synchronous speed, the iron losses increase and hence cause further temperature rise in the motor.

The type of control mode influences temperature rise in the motor:

- A U/F ratio gives the fundamental voltage maximum at 50 Hz but requires more current at low speed to obtain a high starting torque and therefore generates a temperature rise at low speed when the motor is poorly ventilated.
- Flux vector control requires less current at low speed while providing significant torque but regulates the voltage at 50 Hz and causes a voltage drop at the motor terminals, therefore requiring more current at the same power.

Consequences for the motor

Reminder: Leroy-Somer recommends the connection of PTC sensors, monitored by the drive, to protect the motor as much as possible.

CONSEQUENCES OF POWER SUPPLIED BY DRIVES

When power is supplied to the motor by a variable speed drive with diode rectifier, this causes a voltage drop (~5%).

Some PWM techniques can be used to limit this voltage drop (~2%), to the detriment of the machine temperature rise (injection of harmonics of orders 5 and 7).

The non-sinusoidal signal (PWM) provided by the drive generates voltage peaks at the winding terminals due to the significant voltage variations relating to switching of the IGBTs (also called dV/dt). Repeated overvoltages can eventually damage the windings depending on their value and/or the motor design.

The value of the voltage peaks is proportional to the supply voltage. This value can exceed the minimum voltage for the windings which is related to the wire grade, the impregnation type and the insulation that may or may not be present in the slot bottoms or between phases.

Another reason for attaining high voltage values is when regeneration phenomena occur in the case of a driving load, hence the need to prioritise freewheel stops or stops that follow the longest permissible ramp.

General

Operation

Use with speed drive

INSULATION SYSTEM FOR VARIABLE SPEED APPLICATIONS

The insulation system for the LSES, FLSES or PLSES motor series means it can be used on a drive without modification, regardless of the size of the machine or the application, at a supply voltage ≤ 480 V 50/60 Hz and can tolerate voltage peaks up to 1500 V and variations of 3500 V/ μ s at the motor terminals.

These values are guaranteed without using a filter at the motor terminals.

For any voltage > 480 V, Leroy-Somer's reinforced insulation system (RIS) must be used unless otherwise agreed by Leroy-Somer or a sine filter is used (only compatible with a U/F control mode).

RECOMMENDATIONS CONCERNING THE MECHANISM OF ROTATION FOR VARIABLE SPEED APPLICATIONS

The voltage wave form at the drive output (PWM) can generate high-frequency leakage currents which can, in certain situations, damage the motor bearings. This phenomenon is amplified with:

- High mains supply voltages
- Increased motor size
- Incorrectly earthed motor-drive system
- Long cable length between the drive and the motor
- Motor incorrectly aligned with the driven machine

Leroy-Somer machines which have been earthed in accordance with good practice need no special options except in the situations listed below:

- For voltage ≤ 480 V 50/60 Hz, and frame size ≥ 315 mm, we recommend using an insulated NDE bearing.
- For voltage > 480 V 50/60 Hz, and frame size ≥ 315 mm, we recommend using 2 insulated bearings. Another solution could be to only use one insulated NDE bearing, accompanied by a filter at the drive output (dV/dt type or common mode filter).

SUMMARY OF RECOMMENDED PROTECTION

Mains voltage	Cable length	Frame size	Winding protection	Insulated bearings
≤ 480 V	< 20 m	All frame sizes	Standard	No
	> 20 m and < 100 m	≤ 315 ≥ 315	Standard RIS or drive filter	No NDE
≤ 480 V and ≤ 690 V	< 20 m	< 250	Standard	No
		≥ 250	RIS or drive filter	NDE
	> 20 m and < 100 m	≤ 250 ≥ 250	RIS or drive filter RIS or drive filter	NDE NDE

RIS: Reinforced Insulation system.

The filter is recommended above frame size 315.

Standard insulation = **1500 V peak and 3500 V/ μ s.**

For different cable length(s) and/or voltage(s), please consult Leroy-Somer.

EXTREME OPERATING CONDITIONS AND OTHER POINTS

MOTOR CONNECTIONS

Leroy-Somer do not recommend any specific connections for applications operating with a single motor on a single drive.

TRANSIENT OVERLOADS

Drives are designed to withstand transient overload. When the overload values are too high, the system will automatically shut down. Leroy-Somer motors are designed to withstand these overloads, however in the event of very repetitive operation we still recommend use of a temperature sensor at the heart of the motor.

STARTING TORQUE AND CURRENT

Thanks to advances in control electronics, the torque available when the motor is switched on can be adjusted to a value between the rated torque and the variable speed drive breakdown torque. The starting current will be directly related to the torque (120 or 180%).

ADJUSTING THE SWITCHING FREQUENCY

The variable speed drive switching frequency has an impact on losses in the motor and the drive, on the acoustic noise and the torque ripple.

A low switching frequency has an adverse effect on temperature rise in motors.

Leroy-Somer recommends a drive switching frequency of 3 kHz minimum.

In addition, a high switching frequency optimises the acoustic noise and torque ripple level.

OPERATION AT SPEEDS HIGHER THAN THOSE ASSIGNED BY THE MAINS FREQUENCIES

(speed higher than 3600 min⁻¹) can be risky:

- The cage may be damaged
- Bearing life may be impaired
- There may be increased vibration
- Etc.

When high-speed motors are used, they often need to be adapted, **and an in-depth mechanical and electrical design exercise is needed.**

CHOICE OF MOTOR

There are two possibilities:

a - The frequency inverter is not supplied by Leroy-Somer

All the motors in this catalogue can be used with a frequency inverter. Depending on the application, motors will need to be derated by around 10% compared to the motor operating curves in order to guarantee that motors will not be damaged.

b - The frequency inverter is supplied by Leroy-Somer

As these two ranges have been specifically designed for use in combination, excellent performance is guaranteed, in accordance with the curves on the previous page.

Use of motors in the LSMV range, especially in constant torque applications, can achieve unrivalled performance levels.



GOOD WIRING PRACTICE

It is the responsibility of the user and/or the installer to connect the motor-drive system in accordance with the current legislation and regulations in the country of use. This is particularly important as concerns cable size and connection of earths and grounds.

The following information is given for guidance only, and should never be used as a substitute for the current standards, nor does it relieve the installer of his responsibility.

To ensure the safety of motors with frame size 315 mm or above, we recommend installing grounding braids between the terminal box and the housing and/or the motor and the driven machine.

For high-powered motors, unshielded single-core cables can be used as long as they are installed together in a metal cable duct earthed on both sides with a grounding braid.

Cables must be kept as short as possible.

Connection of control and encoder cables



Strip back the shielding on the metal clamp collars in order to ensure 360° contact.

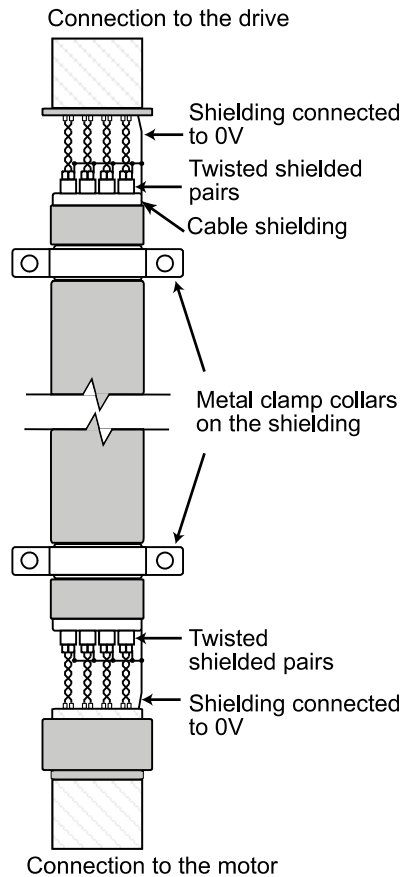

Power cables

The following information is given for guidance only, and should never be used as a substitute for the current standards, nor does it relieve the installer of his responsibility. For more information, please refer to technical specification IEC 60034-25.

To ensure the safety of personnel, the size of the earthing cables should be determined individually in accordance with local regulations.

For compliance with standard EN 61800-3, the power conductors between drive and motor must be shielded. Use a special variable speed cable: shielded with low stray capacity and with 3 PE conductors 120° apart (diagram below). There is no need to shield the drive power supply cables.

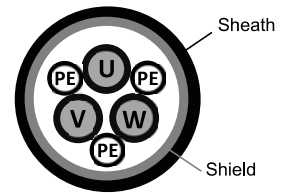

CAUTION: the following configuration is acceptable only if the motor cables include phase conductors with a cross-section below 10 mm² (motors < 30 kW / 40 HP).

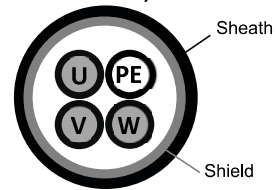

The use of shielded unipolar cables is forbidden.



The variable speed drive wiring must be symmetrical (U,V,W at the motor end must correspond to U,V,W at the drive end) with the cable shielding earthed at both the drive end and motor end over 360°.

When the installation complies with EMC 61800-3 standard on C2 category emissions (if the user has an HV/LV transformer), the shielded motor power supply cable can be replaced with a 3-core + earth cable placed in a fully-enclosed metal conduit (metal cable duct for example).

This metal conduit must be mechanically connected to the electrical cabinet and the structure supporting the motor.

If the conduit consists of several pieces, these should be interconnected by braids to ensure earth continuity.

The cables must be fixed securely at the bottom of the conduit.

The motor earth terminal (PE) must be connected directly to the drive earth terminal.

A separate PE protective conductor is mandatory if the conductivity of the cable shielding is less than 50% of the conductivity of the phase conductor.

IMfinity® 3-phase induction motors - IE2 - IE3 - IE4 - Non IE Efficiency

General Operation

Use with speed drive

TYPICAL INSTALLATION OF A MOTOR-DRIVE

The following information is given for guidance only, and should never be used as a substitute for the current standards, nor does it relieve the installer of his responsibility.

Depending on the installation, more optional elements can be added to the installation:

Fuse switch: a padlockable breaking device to isolate the installation in case of intervention.

This element must ensure thermal and short-circuit protections. The fuse rating is indicated in the drive documentation. The fuse switch can be replaced by a circuit breaker (with a suitable breaking power).

RFI filter: its role is to reduce electromagnetic emissions of drives and hence meet EMC standards. In standard, our drives are fitted with an internal RFI filter. Certain environments require adding an external filter. Refer to the drive documentation for the levels of compliance of the drive, with and without external RFI filter.

Drive supply cables: these cables do not require systematic shielding. Their cross-section is recommended in the drive documentation, however, it can be adapted according to the type of cable, fitting mode, cable length (voltage drop), etc.

Line reactor: it reduces the risk of damage of the drives following an imbalance between phases or strong disturbance on the main supply. The line reactor also reduces low frequency harmonics.

Motor choke: different types of chokes or filters are available. According to the case at hand, the motor choke reduces high frequency leakage currents, differential currents between phases, voltage peaks $dV/dt...$ The choke is chosen according to the distance between motor and drive.

Motor supply cables: these cables must be shielded to ensure EMC compliance of the installation. The cable shield must be connected over 360° at both ends. The cross-section of the cables is recommended in the drive documentation, however, it can be adapted according to the type of cable, fitting mode, cable length (voltage drop), etc.

Encoder cable: the shielding of the sensor cables is important because of the interferences with the power cables. This cable must be laid at least 30 cm away from any power cables.

Power cable sizing: size the drive and motor supply cables according to the applicable standard and operating current, as indicated in the drive documentation.

Factors to be taken into account:

- installation method: inside a duct, a raceway, suspended,...
- Conductor material: copper or aluminium

Once the cable cross-section has been determined, check the voltage drop at the motor terminals. A high voltage drop causes increased current and additional loss in the motor (heating).

Equipotential bonding between the frame, motor, drive and ground carried out in accordance with good practice will contribute significantly to reducing the voltage on the shaft and the motor casing, resulting in fewer high-frequency leakage currents. Premature breakage of bearings and auxiliary equipment, such as encoders, will thus be largely avoided.

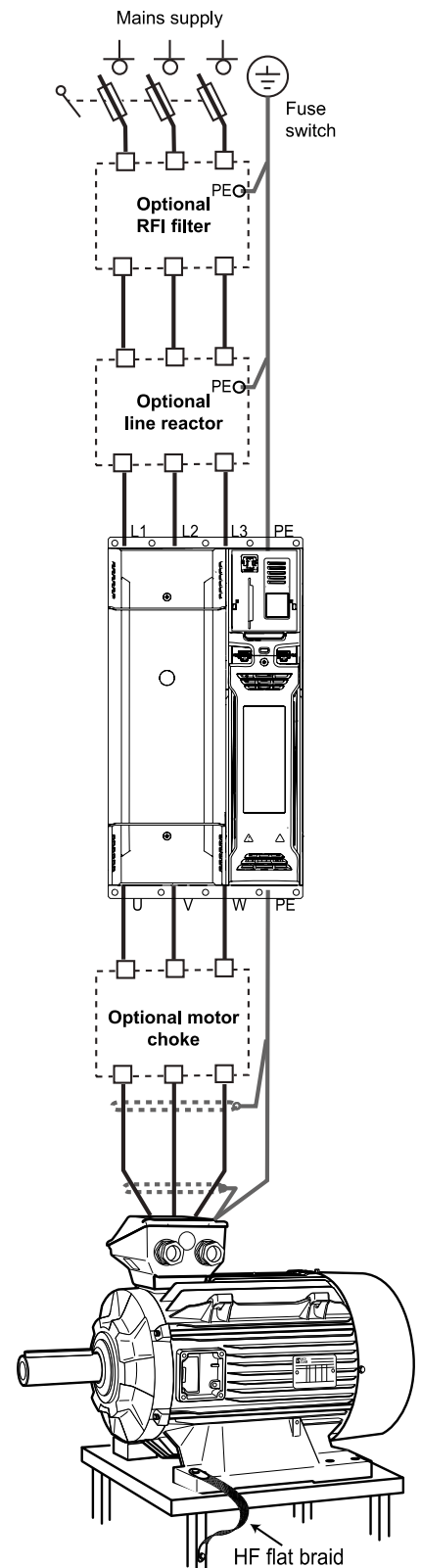

NOISE EMITTED BY ROTATING MACHINES

In a compressible medium, the mechanical vibrations of an elastic body create pressure waves which are characterized by their amplitude and frequency. The pressure waves constitute an audible noise if they have a frequency of between 16 Hz and 16,000 Hz.

Noise is measured by a microphone linked to a frequency analyser. Measurements are taken in an anechoic chamber on machines at no-load, and a sound pressure level L_p or a sound power level L_w can then be established. Measurement can also be carried out in situ on machines which may be on-load, using an acoustic intensity meter which can differentiate between sound sources and identify the sound emissions from the machine. The concept of noise is linked to hearing. The auditory sensation is determined by integrating weighted frequency components with isosonic curves (giving a sensation of constant sound level) according to their intensity.

The weighting is carried out on sound meters using filters whose bandwidth takes into account, to a certain extent, the physiology of the human ear:

- Filter A:** used for low and medium noise levels. High attenuation, narrow bandwidth.
- Filter B:** used for very high noise levels. Wide bandwidth.
- Filter C:** very low attenuation over the whole of the audible frequency range.

A few basic definitions:
 The unit of reference is the bel, and the sub-multiple decibel dB is used here.

Sound pressure level in dB
 $L_p = 20 \log_{10} \left(\frac{P}{P_0} \right)$ $P_0 = 2 \cdot 10^{-5} \text{ Pa}$

Sound power level in dB
 $L_w = 10 \log_{10} \left(\frac{P}{P_0} \right)$ $P_0 = 10^{-12} \text{ W}$

Sound intensity level in dB
 $L_w = 10 \log_{10} \left(\frac{I}{I_0} \right)$ $I_0 = 10^{-12} \text{ W/m}^2$

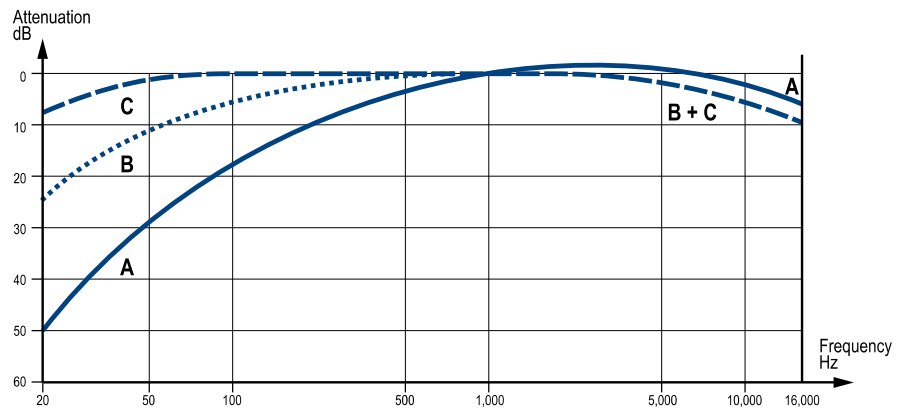

CORRECTION OF MEASUREMENTS

For differences of less than 10 dB between 2 sound sources or where there is background noise, corrections can be made by addition or subtraction using the rules below.

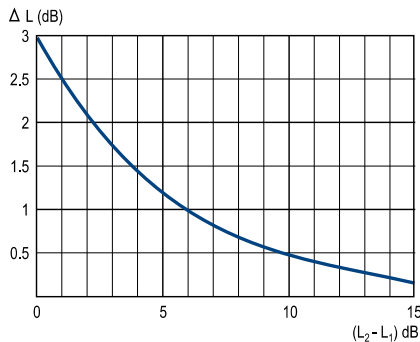

Addition of levels

If L_1 and L_2 are the separately measured levels ($L_2 \geq L_1$), the resulting sound level LR will be obtained by the formula:

$$LR = L_2 + \Delta L$$

ΔL is found by using the curve above.

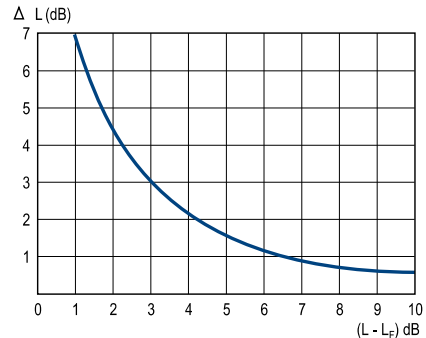

Subtraction of levels*

This is most commonly used to eliminate background noise from measurements taken in a "noisy" environment. If L is the measured level and L_f the background noise level, the actual sound level LR will be obtained by the calculation:

$$LR = L - \Delta L$$

ΔL is found by using the curve above.

*This method is the one normally used for measuring sound power and pressure levels. It is also an integral part of sound intensity measurement.

IMfinity® 3-phase induction motors - IE2 - IE3 - IE4 - Non IE Efficiency

General

Operation

Weighted sound level [dB(A)]

Under IEC 60034-9, the guaranteed values are given for a machine operating at no-load under normal supply conditions (IEC 60034-1), in the actual operating position, or sometimes in the direction of rotation as specified in the design.

This being the case, standardized sound power level limits are shown for the values obtained for the machines described in this catalogue. (Measurements were taken in conformity with standard ISO 1680).

Expressed as sound power level (L_w) according to the standard, the level of sound is also shown as sound pressure level (L_p) in the selection data. The maximum standard tolerance for all these values is + 3 dB(A).



The noise levels of the motors in this catalogue are indicated in the selection tables.

General Operation

Vibration

VIBRATION LEVELS - BALANCING

Inaccuracies due to construction (magnetic, mechanical and air-flow) lead to sinusoidal (or pseudo sinusoidal) vibrations over a wide range of frequencies. Other sources of vibrations disturb operation: bad fastening of the frame, incorrect coupling, bushing misalignment, etc.

We shall first of all look at the vibrations emitted at the operating frequency, corresponding to an unbalanced load, whose amplitude swamps all other frequencies and on which the dynamic balancing of the mass in rotation has a decisive effect.

Under standard ISO 8821, rotating machines can be balanced with or without a key or with a half-key on the shaft extension.

Standard ISO 8821 requires the balancing method to be marked on the shaft extension as follows:

- Half-key balancing: letter H
- Full key balancing: letter F
- No-key balancing: letter N

The machines in this catalogue are in vibration class level A - level B is available on request.

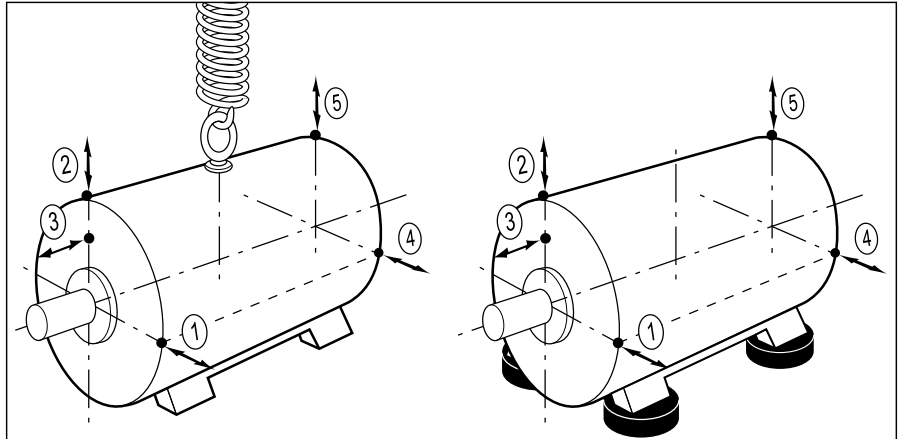

Measuring system for suspended machines

Measuring system for machines on flexible mountings

The measurement points quoted in the standards are indicated in the drawings above.

At each point, the results should be lower than those given in the tables below for each balancing class and only the highest value is to be taken as the "vibration level".

MEASURED MAGNITUDE

The vibration speed can be chosen as the variable to be measured. This is the speed at which the machine moves either side of its static position. It is measured in mm/s.

As the vibratory movements are complex and non-harmonic, it is the root mean square (rms) value of the speed of vibration which is used to express the vibration level.

Measured are the vibratory displacement amplitude (in μm) or vibratory acceleration (in m/s^2). If the vibratory displacement is measured against frequency, the measured value decreases with the frequency: high-frequency vibrations cannot be measured.

If the vibratory acceleration is measured, the measured value increases with the frequency: low-frequency vibrations (unbalanced loads) cannot be measured here.

The rms speed of vibration is the variable chosen by the standards.

However, if preferred, the table of vibration amplitudes may still be used (for measuring sinusoidal and similar vibrations).

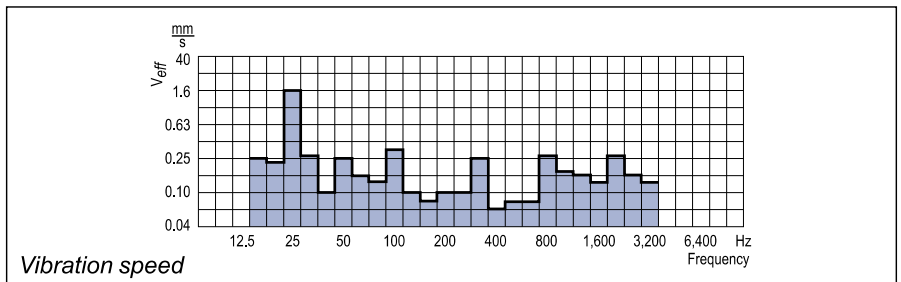

Vibration speed

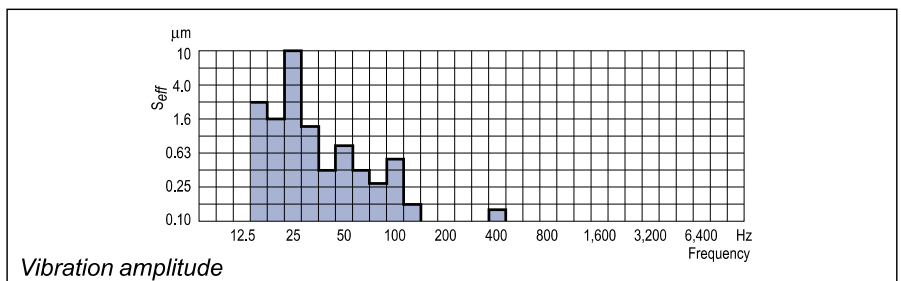

Vibration amplitude

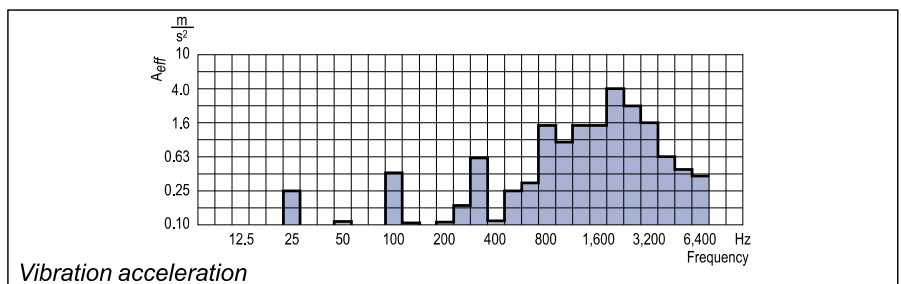

Vibration acceleration

IMfinity® 3-phase induction motors - IE2 - IE3 - IE4 - Non IE Efficiency

General

Operation

Vibration

MAXIMUM VIBRATION MAGNITUDE LIMITS (RMS VALUES), IN TERMS OF DISPLACEMENT, SPEED AND ACCELERATION FOR A FRAME SIZE H (IEC 60034-14)

Vibration level	Frame size H (mm)								
	$56 \leq H \leq 132$			$132 < H \leq 280$			$H > 280$		
	Displacement μm	Speed mm/s	Acceleration m/s^2	Displacement μm	Speed mm/s	Acceleration m/s^2	Displacement μm	Speed mm/s	Acceleration m/s^2
A	25	1.6	2.5	35	2.2	3.5	45	2.8	4.4
B	11	0.7	1.1	18	1.1	1.7	29	1.8	2.8

For large machines and special requirements with regard to vibration, balancing can be carried out *in situ* (finished assembly). Prior consultation is essential, as the machine dimensions may be modified by the necessary addition of balancing disks mounted on the shaft extensions.

IMfinity® 3-phase induction motors - IE2 - IE3 - IE4 - Non IE Efficiency

General

Operation

Optimised performance



THERMAL PROTECTION

Motors are protected by a manual or automatic overcurrent relay, placed between the isolating switch and the motor. This relay may in turn be protected by fuses.

These protection devices provide total protection of the motor against non-transient overloads. If a shorter reaction time is required, if you want to detect transient overloads, or if you wish to monitor temperature rises at "hot spots" in the motor or at strategic points in the installation for maintenance purposes, it

would be advisable to install heat sensors at sensitive points. The various types are shown in the table below, with a description of each. It must be emphasized that under no circumstances can these sensors be used to carry out direct regulation of the motor operating cycles.

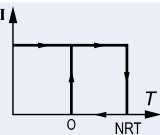
BUILT-IN INDIRECT THERMAL PROTECTIONS

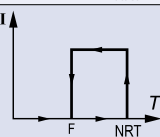
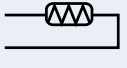
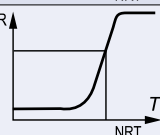
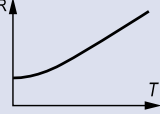
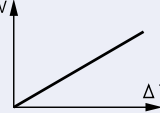
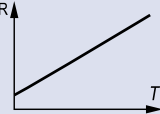
Type	Operating principle	Operating curve	Breaking capacity (A)	Protection provided	Mounting Number of devices*
Normally closed thermal protection PTO	Bimetallic strip, indirectly heated, with normally closed (NC) contact 		2.5 A at 250 V with $\cos \phi$ 0.4	General monitoring for non-transient overloads	Mounting in control circuit 2 in series
Normally open thermal protection PTF	Bimetallic strip, indirectly heated, with normally open (NO) contact 		2.5 A at 250 V with $\cos \phi$ 0.4	General monitoring for non-transient overloads	Mounting in control circuit 2 in parallel
Positive temperature coefficient thermistor PTC	Non-linear variable resistor, indirectly heated 		0	General monitoring for transient overloads	Mounted with associated relay in control circuit 3 in series
Temperature sensor KT Y	Resistance depends on the winding temperature		0	High accuracy continuous surveillance of key hot spots	Mounted in control boards with associated reading equipment (or recorder) 1 per hot spot
Thermocouples T ($T < 150\text{ }^{\circ}\text{C}$) Copper Constantan K ($T < 1000\text{ }^{\circ}\text{C}$) Copper-nickel	Peltier effect		0	Continuous surveillance of hot spots at regular intervals	Mounted in control boards with associated reading equipment (or recorder) 1 per hot spot
Platinum temperature sensor PT 100	Linear variable resistor, indirectly heated		0	High accuracy continuous surveillance of key hot spots	Mounted in control boards with associated reading equipment (or recorder) 1 per hot spot

- NRT: nominal running temperature.

- The NRTs are chosen according to the position of the sensor in the motor and the temperature rise class.

- KT Y 84/130 as standard.

* The number of devices relates to the winding protection.

FITTING THERMAL PROTECTION

- PTO or PTF, in the control circuits
- PTC, with relay, in the control circuits
- PT 100 or thermocouples, with reading equipment or recorder, in the installation control panel for continuous surveillance

ALARM AND EARLY WARNING

All protective equipment can be backed up by another type of protection (with different NRTs): the first device will then act as an early warning (light or sound signals given without shutting down the power circuits), and the second device will be the alarm (shutting down the power circuits).

BUILT-IN DIRECT THERMAL PROTECTIONS

For low rated currents, bimetallic strip-type protection may be used. The line current passes through the strip, which shuts down or restores the supply circuit as necessary. The design of this type of protection allows for manual or automatic reset.

IMfinity® 3-phase induction motors - IE2 - IE3 - IE4 - Non IE Efficiency

General Operation

Starting methods for induction motors

The two essential parameters for starting cage induction motors are:

- starting torque,
- starting current.

These two parameters and the resistive torque determine the starting time.

These three characteristics arise from the construction of cage induction motors. Depending on the driven load, it may be necessary to adjust these values to avoid torque surges on the load or current surges in the supply. There are essentially five different types of supply, which are:

- D.O.L. starting
- star/delta starting
- soft starting with auto-transformer
- soft starting with resistors
- electronic starting

The tables on the next few pages give the electrical outline diagrams, the effect on the characteristic curves, and a comparison of the respective advantages of each mode.

MOTORS WITH ASSOCIATED ELECTRONICS

Electronic starting modes control the voltage at the motor terminals throughout the entire starting phase, giving very gradual smooth starting.

DIGISTART D2 ELECTRONIC STARTER

This simple, compact electronic starter enables three-phase induction motors to be started smoothly by controlling their acceleration. It incorporates motor protection.



- **18 to 200 A range**
 - **Integrated by-pass:** ease of wiring
 - Simplicity and speed of setup
- All settings configured with just seven selector switches
- **Flexibility**
 - Mains supply voltages
200 - 440 VAC & 200 - 575 VAC

- **Starting and stopping modes:**

- Current limit
- Current ramp
- Deceleration control
- Communication
- Modbus RTU, DeviceNet, Profibus, Ethernet/IP, Profinet, Modbus TCP, USB, display console
- Management of pumping functions

DIGISTART D3 ELECTRONIC STARTER

Using the latest electronic control technologies to manage transient phases, the DIGISTART D3 range combines simplicity and user-friendliness while offering the user a high-performance, communicating electronic starter, and can achieve substantial energy savings.



- Range from 23 to 1600A/ 400V or 690V
- Integrated bypass up to 1000 A:
- Compact design Up to 60% space saving.
- Energy saving.
- Reduced installation costs.

- **Advanced control**

- Starting and stopping adapt to the load automatically.
- Automatic parameter optimisation by gradually learning the types of start.
- Special deceleration curve for pumping applications which derives from more than 15 years of Leroy-Somer's experience and expertise.

- **High availability**

- Able to operate with only two power components operational.
- Protection devices can be disabled to implement forced run mode (smoke extraction, fire pump, etc.).

- **Total protection**

- Continuous thermal modelling for maximum motor protection (even in the event of a power cut).

- Trips on configurable power thresholds
- Control of phase current imbalance.
- Monitoring of motor temperatures and the environment with PTC or PT 100.

- **Other features**

- Installation trips in the event of an earth fault
- Connection to "Δ" motor (6-wire)
- Starter size at least one rating lower
- Automatic detection of motor connection
- Ideal for replacing Y/Δ starters

- **Communication**

Modbus RTU, DeviceNet, Profibus, Ethernet/IP, Profinet, Modbus TCP, USB.

- **Simplicity of setup**

- 3 parameter-setting levels
- Preset configurations for pumps, fans, compressors, etc
- Standard: access to the main parameters
- Advanced menu: access to all data.
- Storage
- Time-stamped log of trips
- Energy consumption and operating conditions
- Latest modifications
- Simulate operation by forcing control
- Display the state of the inputs/outputs
- Counters: running time, number of starts, etc.

INTEGRATED VARIABLE SPEED MOTOR

These motors (VARMECA type) are designed and developed with built-in electronics.

- **Characteristics:**

- $0.75 < P \leq 7.5 \text{ kW}^*$
 - 50/60 Hz
 - $360 < \text{speed} < 2400 \text{ min}^{-1}$ (4-pole motors)
 - $\text{Cos } \varphi = 1$
 - Constant torque
- * other power ranges on request*

- **Starting on variable speed drive**

One of the advantages of variable speed drives is that loads can be started without a current surge on the mains supply, since starting is always performed with no voltage or frequency at the motor terminals.

IMfinity® 3-phase induction motors - IE2 - IE3 - IE4 - Non IE Efficiency

General

Operation

Starting methods for induction motors

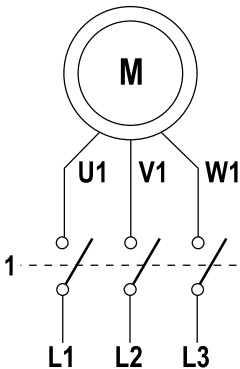
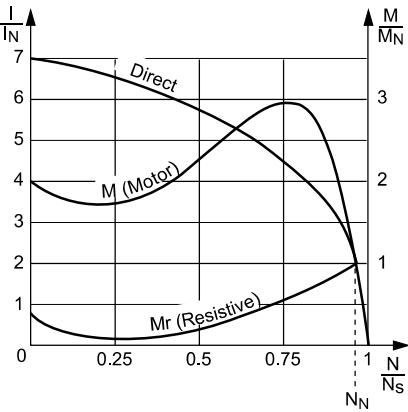
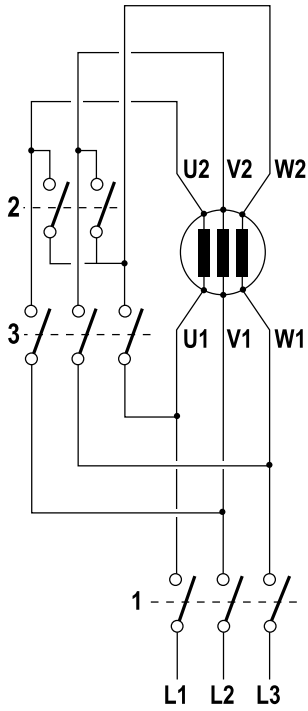
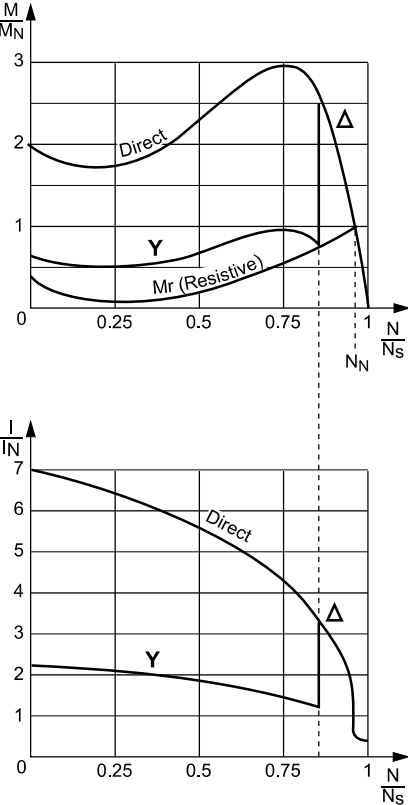
Mode	Outline diagram	Characteristic curves	Number of steps	Starting torque	Starting current	Advantages
D.O.L.			1	M_D	I_D	<ul style="list-style-type: none"> Simplicity of the equipment High torque Minimum starting time
Star-Delta			2	$M_D/3$	$I_D/3$	<ul style="list-style-type: none"> Starting current divided by 3 Simple equipment 3 contactors including 1 two-pole

IMfinity® 3-phase induction motors - IE2 - IE3 - IE4 - Non IE Efficiency

General

Operation

Starting methods for induction motors

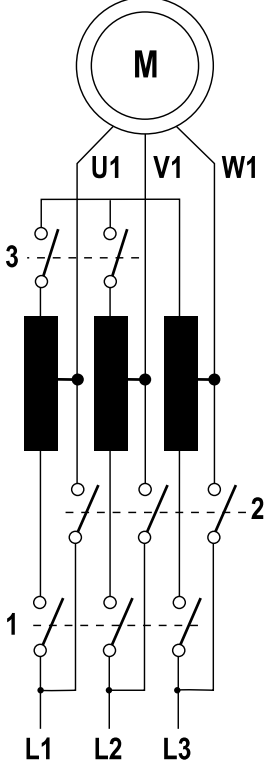
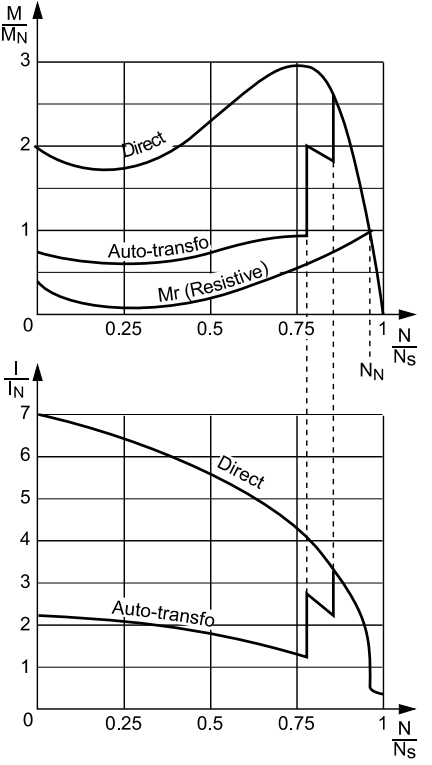
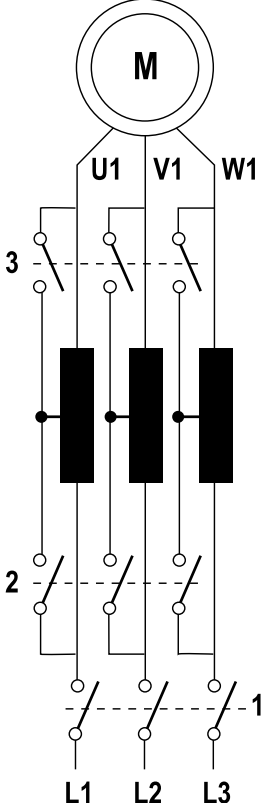
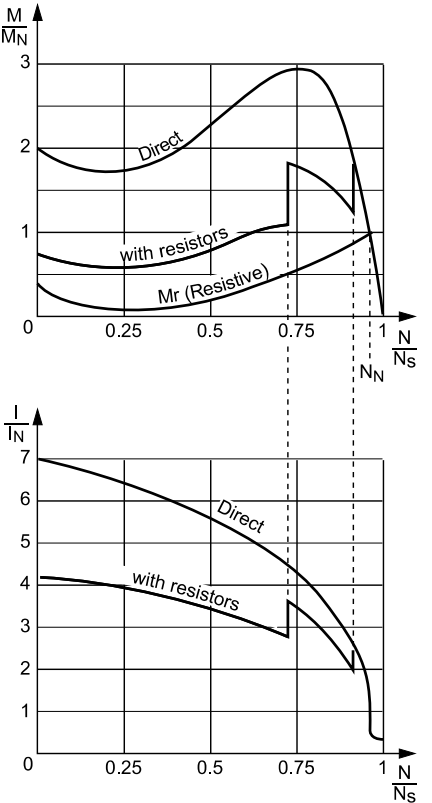
Mode	Outline diagram	Characteristic curves	Number of steps	Starting torque	Starting current	Advantages
<p>Soft starting with autotransformer</p>			$n \geq 3$	$K^2 \cdot M_D$	$K^2 \cdot I_D$	<p>Can be used to select the torque</p> <p>Current reduction proportional to that for the torque</p> <p>No power cut-off</p>
<p>Soft starting with resistors</p>			n	$K^2 \cdot M_D$	$K \cdot I_D$	<p>Can be used to select the torque or the current</p> <p>No power cut-off</p> <p>Modest additional cost (1 contactor per step)</p>

IMfinity® 3-phase induction motors - IE2 - IE3 - IE4 - Non IE Efficiency

General

Operation

Starting methods for induction motors

Mode	Outline diagram	Characteristic curves	Number of steps	Starting torque	Starting current	Advantages
DIGISTART D2 & D3				$K^2 M_D$	$K I_D$	<ul style="list-style-type: none"> Adjustable on site Choice of torque and current No power cut-off Smooth starting Compact size No maintenance High number of starts Digital Integrated motor and machine protection Serial link
DIGISTART D3 mode «6-wire»				$K^2 M_D$	$K I_D$	<ul style="list-style-type: none"> Same advantages as the above DIGISTART Current reduced by 35% Suitable for retrofitting on installations Y-D With or without bypass

General Operation

Braking

GENERAL

The braking torque equals the torque developed by the motor increased by the resistant torque of the driven machine.

$$C_f = C_m + C_r$$

- C_f = braking torque
- C_m = motor torque
- C_r = resistive torque

Braking time, ie. the time required for an induction motor to change from speed N to stop, is calculated by the formula:

$$T_f = \frac{\pi \cdot J \cdot N}{30 \cdot C_f(\text{moy})}$$

- T_f (in s) = braking time
- J (in kgm^2) = moment of inertia
- N (in min^{-1}) = speed of rotation
- $C_f(\text{av})$ (in N.m) = average braking torque during the time period

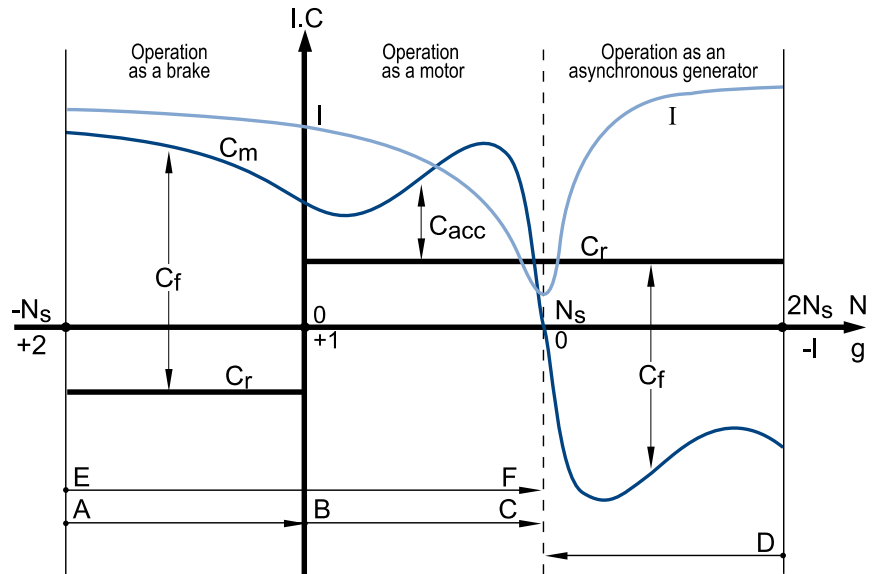

Curves $I = f(N)$, $C_m = f(N)$, $C_r = f(N)$, in the motor's starting and braking zones.

- I = current absorbed
- C = torque value
- C_f = braking torque
- C_r = resistive torque
- C_m = motor torque
- N = speed of rotation
- g = slip
- N_s = synchronous speed
- AB = reverse current braking
- BC = starting, acceleration
- DC = regenerative braking
- EF = reversal

REVERSE-CURRENT BRAKING

This method of braking is obtained by reversing two of the phases.

In general, an isolator disconnects the motor from the supply at the time the speed changes to $N=0$.

In cage induction motors, the average braking torque is generally greater than the starting torque.

Braking torque varies in different types of machine, as it depends on the rotor cage construction.

This method of braking involves a large amount of absorbed current, more or less constant and slightly higher than the starting current.

Thermal stresses during braking are three times higher than during acceleration.

Accurate calculations are required for repetitive braking.

Note: The direction of rotation of a motor is changed by reverse-current braking and restarting.

Thermically, one reversal is the equivalent of 4 starts. Care must therefore be taken when choosing a machine.

D.C. INJECTION BRAKING

Operating stability can be a problem when reverse-current braking is used, due to the flattening out of the braking torque curve in the speed interval $(0, -N_s)$.

There is no such problem with D.C. injection braking: this can be used on both cage induction and slip-ring motors. With this braking method, the induction motor is connected to the mains and braking occurs when the A.C. voltage is cut off and D.C. voltage is applied to the stator.

There are four different ways of connecting the windings to the D.C. voltage.

The D.C. voltage applied to the stator is usually supplied by a rectifier plugged into the mains.

Thermal stresses are approximately three times lower than for reverse-current braking.

The shape of the braking torque curve in the speed interval $(0, -N_s)$ is similar to that of the curve $T_m = f(N)$ and is obtained by changing the abscissa variable to $N_f = N_s - N$.

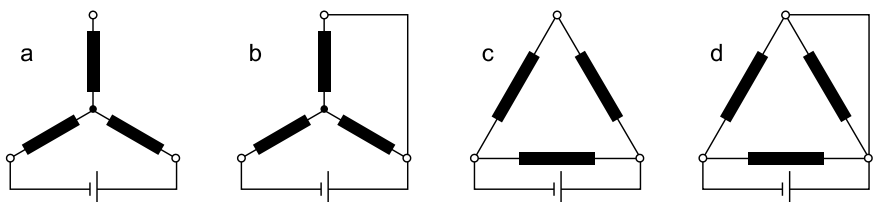

Motor winding connections for D.C. voltage

General Operation

Braking

The braking current is calculated using the formula:

$$I_f = k1_i \times I_d \sqrt{\frac{C_f - C_{f0}}{k2 - C_d}}$$

The values of k1 according to the 4 couplings are:

$$\begin{aligned} k1_a &= 1.225 & k1_c &= 2.12 \\ k1_b &= 1.41 & k1_d &= 2.45 \end{aligned}$$

The braking torque can be found by:

$$C_f = \frac{\pi \cdot J \cdot N}{30 \cdot T_f}$$

In the formulae above:

- If (in A) = direct current for braking
- Id (in A) = starting current in the phase
= $\frac{1}{\sqrt{3}}$ Id as per catalogue (for Δ connection)
- Cf (in N.m) = average braking torque during the time period (Ns, N)
- Cf (in N.m) = external braking torque
- Cd (in N.m) = starting torque
- J (in kgm²) = total moment of inertia at motor shaft
- N (in min⁻¹) = speed of rotation
- Tf (in s) = braking time
- k1i = numerical factors for connections a, b, c and d in the diagram
- k2 = numerical factors taking account of the average braking torque (k2 = 1.7)

The D.C. voltage to be applied to the windings is calculated by:

$$U_f = k3_i \cdot k4 \cdot I_f \cdot R1$$

k3 values for the four diagrams are as follows:

$$\begin{aligned} k3_a &= 2 & k3_b &= 1.5 \\ k3_c &= 0.66 & k3_d &= 0.5 \end{aligned}$$

- Uf (in V) = D.C. voltage for braking
- If (in A) = direct current for braking
- R1 (in Ω) = stator phase resistance at 20°C
- k3i = numerical factors for diagrams a, b, c and d
- k4 = numerical factor taking account of the temperature rise in the motor (k4 = 1.3)

MECHANICAL BRAKING

Electromechanical brakes (D.C. or A.C. field excitation) can be fitted at the nondrive end of the motor.

For further details, see our "Brake motors" catalogue.

REGENERATIVE BRAKING

This is the braking method applied to multi-speed motors when changing down to lower speeds. This procedure cannot be used to stop the motor.

Thermal stresses are approximately equal to those occurring when motors with Dahlander connections are started at the lower rated speed (speed ratio 1 : 2).

With the motor at the lower speed, working as an asynchronous generator, it develops very high braking torque in the speed interval (2Ns, Ns).

The maximum braking torque is slightly higher than the starting torque of the motor at the lower speed.

DECELERATION BRAKES

For safety reasons, deceleration brakes are fitted at the rear of motors used on hazardous machines (for example, where cutting tools may come into contact with the operator).

The range of brakes is determined by its braking torques:
2.5 - 4 - 8 - 16 - 32 - 60 N.m

The appropriate brake is selected in the factory according to the number of motor poles, the driven inertia, the number of brakings per hour and the required braking time.



IMfinity® 3-phase induction motors - IE2 - IE3 - IE4 - Non IE Efficiency

General

Operation

Operation as an asynchronous generator

GENERAL

The motor operates as an asynchronous generator each time the load becomes a driving load and the rotor speed exceeds the synchronous speed (N_s).

This can be induced either voluntarily, as in the case of electric power stations (water or wind power, etc) or involuntarily, caused by factors linked to the application (downward movement of crane hooks or blocks, inclined conveyors, etc).

OPERATING CHARACTERISTICS

The diagram opposite shows the various operations of an asynchronous machine in relation to its slip (g) or its speed (N).

Example: Let us consider an induction motor of 45 kW, 4 poles, 50 Hz at 400 V. As a rough estimate, its characteristics as an asynchronous generator can be deduced from its rated characteristics as a motor, by applying the rules of symmetry.

If more precise values are required, the manufacturer should be consulted.

In practice, it is confirmed that the same machine, operating as a motor and as a generator with the same slip, has approximately the same losses in both cases, and therefore virtually the same efficiency. It can be deduced from this that the rated electrical power supplied by the asynchronous generator will be virtually the same as the motor output power.

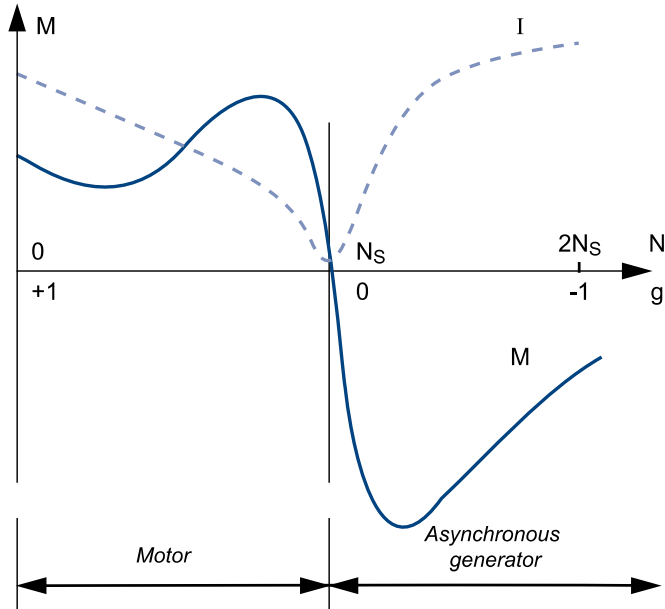

Characteristics	Motor	AG
Synchronism speed (min^{-1})	1500	1500
Rated speed (min^{-1})	1465	1535
Rated torque (m.N)	+ 287	- 287
Rated current under 400 (A)	87 A (absorbed)	87 A (supplied)

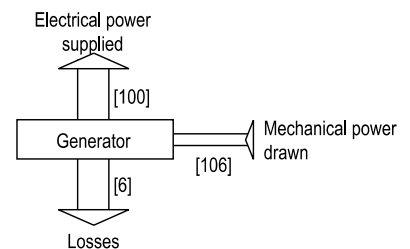
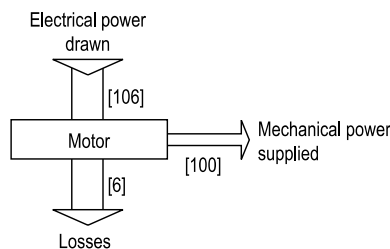

General

Operation

Operation as an asynchronous generator

CONNECTION TO A POWERFUL MAINS SUPPLY

It is assumed that the machine stator is connected to a powerful electrical mains supply (usually the national grid), ie. a mains supply provided by a generator which regulates the power to at least twice that of the asynchronous generator.

Under these conditions, the mains supply imposes its own voltage and frequency on the asynchronous generator. Furthermore, it supplies it automatically with the reactive energy necessary for all its operating conditions.

CONNECTION - DISCONNECTION

Before connecting the asynchronous generator to the mains supply, it is necessary to ensure that the direction of phase rotation of the asynchronous generator and the mains supply are in the same order.

- To connect an asynchronous generator to the mains supply, it should be accelerated gradually until it reaches its synchronous speed N_s . At this speed, the machine torque is zero and the current is minimal.

This is an important advantage of asynchronous generators: as the rotor is not polarised until the stator is powered up, it is not necessary to synchronise the mains supply and the machine when they are connected.

However, there is a phenomenon affecting the connection of asynchronous generators which, in some cases, can be a nuisance: the rotor of the asynchronous generator, although not energised, still has some residual magnetism.

On connection, when the magnetic flux created by the mains supply and that caused by the rotor residual magnetism are not in phase, the stator experiences a very brief current peak (one or two halfwaves), combined with an instantaneous overtorque of the same duration.

It is advisable to use connecting stator resistances to limit this phenomenon.

- Disconnecting the asynchronous generator from the mains supply does not pose any particular problem.

As soon as the machine is disconnected, it becomes electrically inert since it is no longer energised by the mains supply. It no longer brakes the driving machine, which should therefore be stopped to avoid reaching overspeed.

Reactive power compensation

To limit the current in the lines and the transformer, the asynchronous generator can be compensated by restoring the power factor of the installation to the unit, using a bank of capacitors.

In this case, the capacitors are only inserted at the terminals of the asynchronous generator once it has been connected, to avoid self-energisation of the machine due to the residual magnetism during speed pick up. For a 3-phase low voltage asynchronous generator, 3-phase or single-phase capacitors in delta connection are used.

Electrical protection and safety

There are two protection and safety categories:

- those which relate to the mains
- those which relate to the set and its generator

The major mains protection devices monitor:

- maximum-minimum voltage
- maximum-minimum frequency
- minimum power or energy feedback (operating as a motor)
- generator connection fault

The protection devices for the set are:

- stop on detection of racing start
- stop on detection of lubrication faults
- thermal magnetic protection of the generator, usually with probes in the winding.

POWER SUPPLY FOR AN ISOLATED NETWORK

This concerns supplying a consuming network which does not have another generator of sufficient power to impose its voltage and frequency on the asynchronous generator.

REACTIVE POWER COMPENSATION

In the most common case, reactive energy must be supplied:

- to the asynchronous generator,
- to the user loads which consume it.

To supply both of these consumption types with reactive energy, a reactive energy source of suitable power is connected in parallel on the circuit. This is usually a bank of capacitors with one or more stages which may be fixed, manually adjusted (using notches) or automatically adjusted. Synchronous capacitors are now rarely used.

Example: In an isolated network with power consumption of 50 kW where $\cos \varphi = 0.9$ (and $\tan \varphi = 0.49$), supplied by an asynchronous generator with $\cos \varphi$ of 0.8 at 50 kW (and $\tan \varphi = 0.75$), it is necessary to use a bank of capacitors which supplies: $(50 \times 0.49) + (50 \times 0.75) = 62$ kvar.



IMfinity® 3-phase induction motors - IE2 - IE3 - IE4 - Non IE Efficiency

General

Electrical and mechanical data

Identification

INFORMATION PLATES

The information plate identifies the motors, indicate the main performance and show compatibility of the motor concerned with the main standards and concerning them.

All motors in this catalogue with a power between 0.75 and 375 kW are fitted with two information plates: one indicating the motor's performance when supplied by the grid, and the other the motor's performance when supplied through an inverter.

The following table provides a clear vision of compliance of the motors with the different European and North-American regulations and standards.

		Plate marking	CE	cURus	cCSAus	IEC & CE (IE3 or IE2)	CSAE	ee (CC055B)	NEMA Premium
Aluminium motors LS / LSES	Power < 7.5 kW	2 & 4 P	Standard	Standard	Option	Standard	Option	Standard ²	Standard ²
		6 P	Standard	Standard	Option	Standard	Option	Option	Option
	Puissance ≥ 7.5 kW	2 & 4 P	Standard	Standard	Standard	Standard	Standard	Standard	Standard
		6 P	Standard	Standard	Standard	Standard	Option	Option	Option
FLSES cast iron motors	Power > 0.75 kW	2, 4 & 6 P	Standard	Standard	-	Standard	-	-	-
PLSES IP 23 Drip-proof motors	Power > 55 kW	2 & 4 P	Standard	Standard	-	Standard	-	-	-

1. Non-IE motors are not CE plated

2. except 2 P: 1.8 kW, 3 kW, 3.7 kW and 4 P: 0.9 kW, 1.8 kW, 2.2 kW = option

Option: available upon request. In certain cases, may result in a modification or specific dimensioning of the motor.

DEFINITION OF SYMBOLS USED ON NAMEPLATES

 Legal mark of compliance of equipment with the requirements of European Directives

Main supply plate:

MOT 3 ~ : Three-phase A.C. motor
LSES : Series
200 : Frame size
LU : Housing symbol
T : Impregnation index

Motor no.

789456 : Motor batch number
F : Month of production
14 : Year of production
001 : Serial number
IE3 : Efficiency class
93.6% : Efficiency at 4/4 load

IP55 IK08 : Degree of protection
I cl. F : Insulation class F
40°C : Ambient operating temperature
S1 : Duty - Duty (operating) factor
kg : Weight
V : Supply voltage
Hz : Supply frequency
min⁻¹ : Revolutions per minute (rpm)
kW : Rated output power
cos φ : Power factor
A : Rated current
Δ : Delta connection
Y : Star connection

Bearings

DE : Drive end
 Drive end bearing
NDE : Non drive end bearing
 Bearing on end opposite the drive
g : Amount of grease at each regreasing (in g)
h : Regreasing interval (in hours)
POLYREX EM103 : Type of grease

 : Vibration level

 : Balancing mode

Please quote when ordering spare parts

Inverter supply plate:

Inverter settings : Parameter setting the frequency inverter
Motor performance : Torque available on the motor shaft in % rated torque at the plate frequencies
Min. Fsw (kHz) : Minimum cut-off frequency acceptable for the motor
Nmax (min⁻¹) : Maximum mechanical speed acceptable for the motor

IMfinity® 3-phase induction motors - IE2 - IE3 - IE4 - Non IE Efficiency

General

Electrical and mechanical data

Identification

INFORMATION PLATES LSES ALUMINIUM MOTORS

IE3 power ≥ 7.5 kW*

Main supply plate

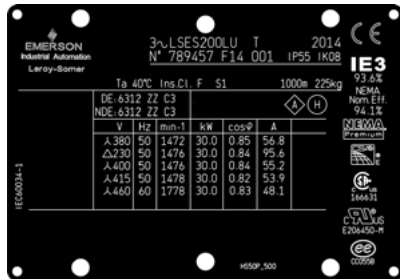

Inverter supply plate

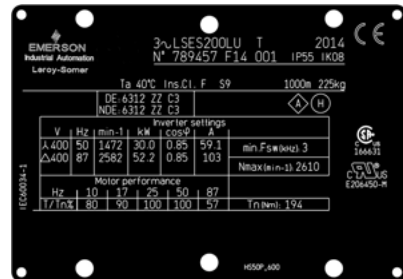

IE3 power < 7.5 kW*

Main supply plate

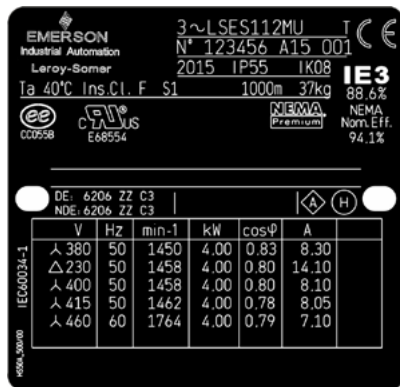

Inverter supply plate

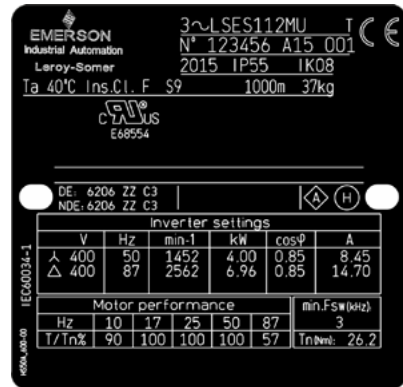

* Valid only for 2 & 4 pole motors except 2P 3 kW and 4P 2.2 kW.

Aluminium 6P motors all powers and 2P 3 kW and 4P 2.2 kW are available in CSAe, ee, cCSAus, NEMA Premium version as options upon specific request.

IE2 power ≥ 7.5 kW

Main supply plate

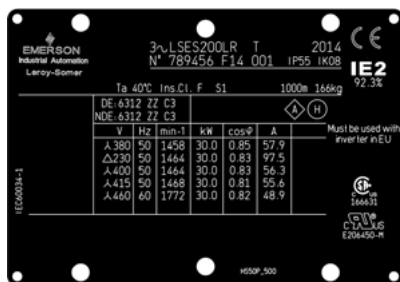

Inverter supply plate

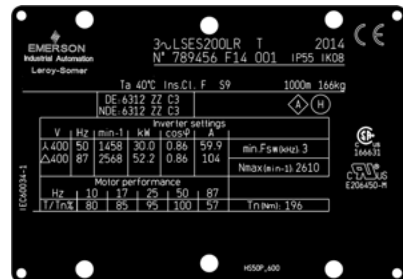

IE2 power < 7.5 kW

Main supply plate

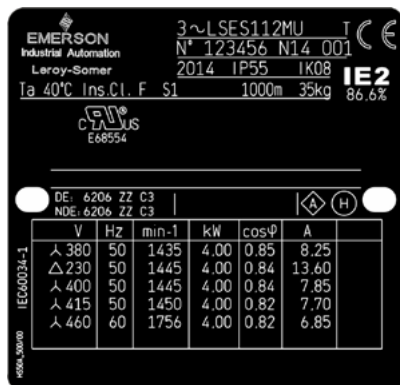

Inverter supply plate

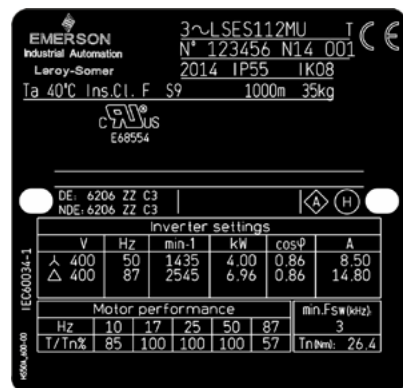

Plate values provided for information only.

IMfinity® 3-phase induction motors - IE2 - IE3 - IE4 - Non IE Efficiency

General

Electrical and mechanical data

Identification

INFORMATION PLATES FLSES CAST IRON MOTORS

IE2

Main supply plate

EMERSON Industrial Automation Leroy-Somer		MOT. 3~ FLSES 315 LB		CE	
N° 62349200XM01		2014	1220 kg		
DE 6320 C3	50 g	12400 h	IP 55	1000 m	
NDE 6316 C3	33 g	12400 h	IK 08	IM 1001	IE2
40 °C		Ins cl. F	S1	100%	6 d/h SF 1.0
V	Hz	min ⁻¹	kW	A	cos φ %
Δ 400	50	1486	200	357	0.85
Δ 690	50	1486	200	206	0.85
Δ 380	50	1483	200	367	0.87
Δ 415	50	1487	200	348	0.84
Δ 460	60	1785	200	308	0.85
95.1 %					
Must be used with inverter in EU Polyrex EM 103					
E68554-B IEC 60034-1 - MADE IN FRANCE					

IE3

Main supply plate

EMERSON Industrial Automation Leroy-Somer		MOT. 3~ FLSES 315 LB		CE	
N° 62349200XM01		2014	1220 kg		
DE 6320 C3	50 g	12400 h	IP 55	1000 m	
NDE 6316 C3	33 g	12400 h	IK 08	IM 1001	IE3
40 °C		Ins cl. F	S1	100%	6 d/h SF 1.0
V	Hz	min ⁻¹	kW	A	cos φ %
Δ 400	50	1486	200	354	0.85
Δ 690	50	1486	200	204	0.85
Δ 380	50	1483	200	364	0.87
Δ 415	50	1487	200	345	0.84
Δ 460	60	1785	200	307	0.85
96.0 %					
Polyrex EM 103					
E68554-B IEC 60034-1 - MADE IN FRANCE					

IE4

Main supply plate

EMERSON Industrial Automation Leroy-Somer		MOT. 3~ FLSES 355 LB 4		CE	
N° 61138201DF01		2015	1650 kg		
DE 6322 C3	60 g	8316 h	IP 55	1000 m	
NDE 6316 C3	33 g	8316 h	IK 08	IM 1001	IE4
40 °C		Ins cl. F	S1	100%	6 d/h SF 1.0
V	Hz	min ⁻¹	kW	A	cos φ %
Δ 400	50	1490	250	439	0.85
Δ 690	50	1490	250	253	0.85
Δ 380	50	1488	250	454	0.87
Δ 415	50	1491	250	428	0.84
Δ 460	60	1791	250	381	0.85
96.7 %					
Polyrex EM 103					
E68554-B IEC 60034-1 - MADE IN FRANCE					

Inverter supply plate (for IE2-IE3-IE4)

EMERSON Industrial Automation Leroy-Somer		MOT. 3~ FLSES 315 LB		CE		
N° 62349200XM01		2014	1220 kg			
DE 6320 C3	50 g	12400 h	IP 55	1000 m		
NDE 6316 C3	33 g	12400 h	IK 08	IM 1001		
40 °C		Ins cl. F	S9	%	d/h SF	
Inverter settings						
V	Hz	min ⁻¹	kW	A	cos φ	
Δ 400	50	1486	200	357	0.85	
min. Fsw (kHz): 3 Nmax (min ⁻¹): 2610						
Motor performance						
Hz	10	17	25	50	60	87
T/Tn%	85	93	100	100	82.3	54.6
Polyrex EM 103						
E68554-B IEC 60034-1 - MADE IN FRANCE						

INFORMATION PLATES PLSES DRIP-PROOF MOTORS

IE3

Main supply plate

EMERSON Industrial Automation Leroy-Somer		3~ PLSES315LUS T		CE	
N° 789456 F14 001		2014			
Ta 40°C		Ins.Cl. F	S1	1000m	960kg
DE: 6320 C3	POLYREX EM103		A H		
NDE: 6316 C3	48g / 7800h				
V	Hz	min-1	kW	cosφ	A
Δ 380	50	1484	250	0.85	466
Δ 400	50	1486	250	0.83	450
Δ 690	50	1486	250	0.83	260
Δ 415	50	1488	250	0.81	446
Δ 460	60	1790	250	0.82	398
E68554-M IEC 60034-1					

Inverter supply plate

EMERSON Industrial Automation Leroy-Somer		3~ PLSES315LUS T		CE	
N° 789456F14 001		2014			
Ta 40°C		Ins.Cl. F	S9	1000m	960kg
DE: 6320 C3	POLYREX EM 103		A H		
NDE: 6316 C3	48g / 10200h				
Inverter settings					
V	Hz	min-1	kW	cosφ	A
Δ 400	50	1484	250	0.85	478
min. Fsw(kHz): 3 Nmax(min-1): 2610					
Motor performance					
Hz	10	17	25	50	87
T/Tn%	70	80	90	100	57
Tn (rpm): 1610					
E68554-M IEC 60034-1					

Plate values provided for information only.

IMfinity® 3-phase induction motors - IE2 - IE3 - IE4 - Non IE Efficiency

General

Electrical and mechanical data

Identification

INFORMATION PLATES LS ALUMINIUM MOTORS

EMERSON Industrial Automation Leroy-Somer
 ~3 LS7M/T_ N°502131/001/2015
 IP 55 IK 00 Isol.CLF 40°C amb S1 7,5 kg

V	Hz	min-1	kW	cos φ	A
Δ 230	50	1420	0,37	0,7	1,9
Y 380/400	50	1410	0,37	0,7	1,1
T 415	50	1430	0,37	0,65	1,1
T 440/460	60	1710	0,44	0,7	1,1

IEC60034-1

Frame size 56 to 71

EMERSON Industrial Automation Leroy-Somer
 3~LS112M T N° 123456 F15 001
 2015 IP55 IK08 Tg 40°C Ins.Cl. F S1 1000h 23kg

DE 4204 Z2 C3 NDE 4205 Z2 C3

V	Hz	min-1	kW	cosφ	A
Δ 380	50	1420	4,00	0,84	8,90
Δ 400	50	1430	4,00	0,79	8,95
Δ 415	50	1430	4,00	0,79	5,15
Δ 440	50	1440	4,00	0,75	9,10
Δ 460	60	1730	4,00	0,81	8,60

IEC60034-1

Frame size 80 to 160 M

EMERSON Industrial Automation Leroy-Somer
 3~LS200LR T 2015 N° 789456 F14 001 IP55 IK08
 Tg 40°C Ins.Cl. F S1 1000h 14kg

DE 6312 Z2 C3 NDE 6312 Z2 C3

V	Hz	min-1	kW	cosφ	A
A 380	50	1458	30,0	0,85	57,9
Δ 230	50	1464	30,0	0,83	97,5
A 400	50	1464	30,0	0,83	56,7
A 415	50	1468	30,0	0,81	55,6
A 460	60	1772	30,0	0,82	48,9

IEC60034-1

Frame size 160 L to 225

IMfinity® 3-phase induction motors - IE2 - IE3 - IE4 - Non IE Efficiency IP55 aluminium frame

Contents

GENERAL INFORMATION	64-65
Designation.....	64
Description.....	65
ELECTRICAL AND MECHANICAL DATA	66 to 76
Non IE efficiency	66-67
IE2 powered by the mains.....	68-69
IE2 powered by the drive.....	70-71
IE3 powered by the mains.....	72-73
IE3 powered by the drive.....	74-75
Mains connection.....	76
DIMENSIONS.....	77 to 82
Shaft extensions	77
Foot mounted IM 1001 (IM B3).....	78
Foot and flange mounted IM 2001 (IM B35)	79
Flange mounted IM 3001 (IM B5) IM 3011 (IM V1).....	80
Foot and face mounted IM 2101 (IM B34)	81
Face mounted IM 3601 (IM B14).....	82
CONSTRUCTION.....	83 to 94
Bearings and lubrication	83-84
Axial loads	85 to 87
Radial loads	88 to 94
OPTIONAL EQUIPMENT.....	95 to 97
Non-standard flanges	95
Mechanical options.....	96
Mechanical and electrical options	97
INSTALLATION AND MAINTENANCE.....	98
Position of the lifting rings	98

IMfinity® 3-phase induction motors - IE2 - IE3 - IE4 - Non IE Efficiency

IP55 aluminium frame

General information

Designation

IP55 ALUMINIUM MOTORS



IP 55
Cl. F - ΔT 80 K

The complete motor **reference** described below will enable you to order the desired **equipment**.

The selection method consists of following the terms in the designation.

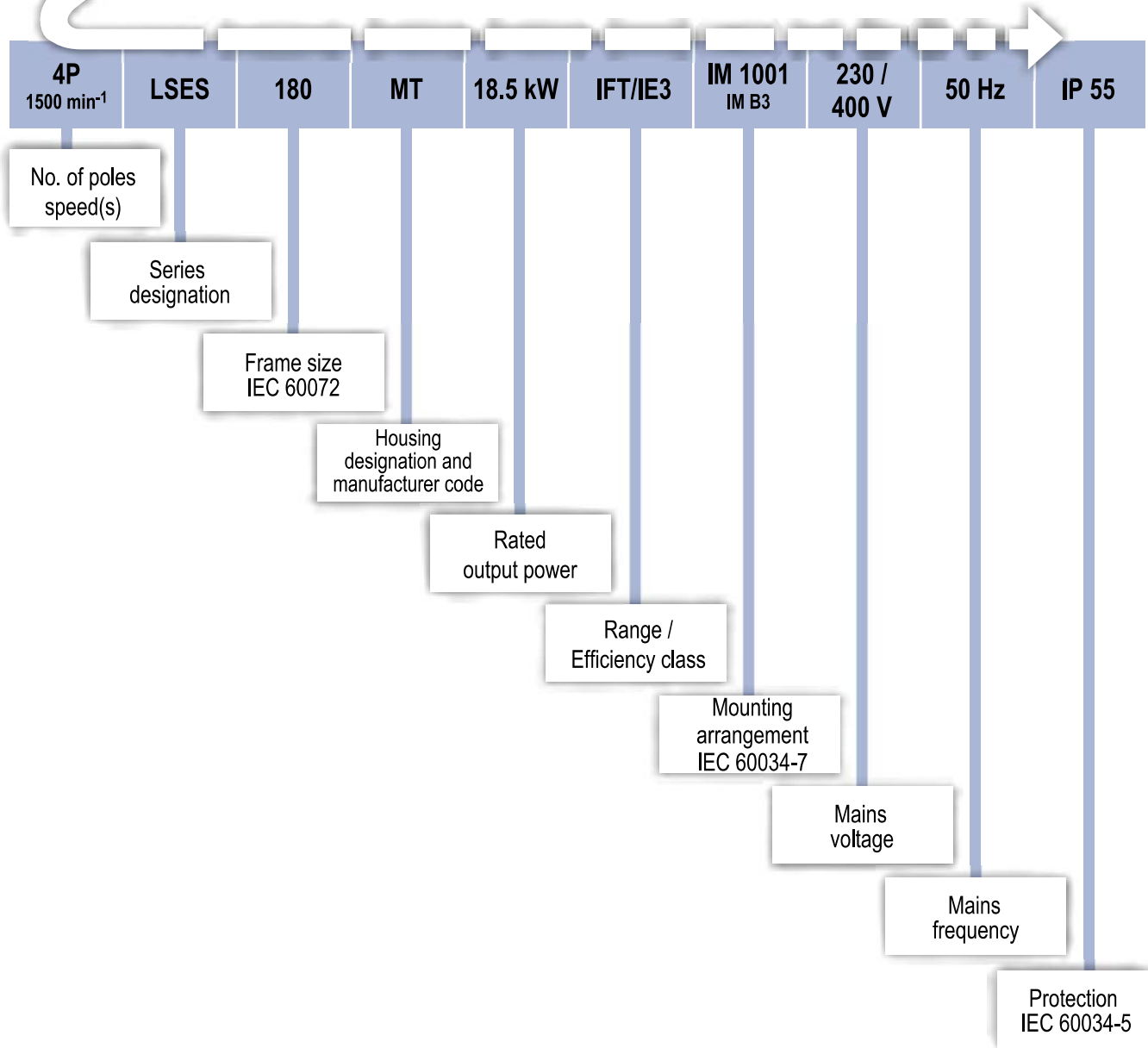

IMfinity® 3-phase induction motors - IE2 - IE3 - IE4 - Non IE Efficiency

IP55 aluminium frame

General information

Description

Component	Materials	Remarks
Housing with cooling fins	Aluminium alloy	<ul style="list-style-type: none"> - with integral or screw-on feet, or without feet - 4 or 6 fixing holes for housings with feet - lifting rings for frame size ≥ 100 - earth terminal with an optional jumper screw
Stator	Insulated low-carbon magnetic steel laminations Electroplated copper	<ul style="list-style-type: none"> - low carbon content guarantees long-term lamination pack stability - semi-enclosed slots - class F insulation
Rotor	Insulated low-carbon magnetic steel laminations	<ul style="list-style-type: none"> - inclined cage bars - rotor cage pressure die-cast in aluminium (or alloy for special applications) - shrink-fitted to shaft - rotor balanced dynamically, 1/2 key
Shaft	Steel	<ul style="list-style-type: none"> - for frame size ≤ 160 MP - LR: <ul style="list-style-type: none"> • tapped hole • closed keyway - for frame size ≥ 160 M - L: <ul style="list-style-type: none"> • tapped hole • open keyway
End shields	Aluminium alloy	<ul style="list-style-type: none"> - 56 - 63 - 71 front and rear - 80 - 90 NDE shield
	Cast iron	<ul style="list-style-type: none"> - 80 - 90 DE shield (except for 6-pole version and optional for 80 and 90 NDE shield) - 100 to 315 DE shield and NDE shield
Bearings and lubrication		<ul style="list-style-type: none"> - permanently greased bearings frame size 56 to 225 - regreasable bearings frame size 250 to 315 - bearings preloaded at non drive end
Labyrinth seal Lipseals	Plastic or steel Synthetic rubber	<ul style="list-style-type: none"> - lipseal or deflector at drive end for all flange mounted motors - lipseal, deflector or labyrinth seal for foot mounted motors
Fan	Composite material or aluminium alloy	<ul style="list-style-type: none"> - 2 directions of rotation: straight blades
Fan cover	Composite material or pressed steel	<ul style="list-style-type: none"> - fitted, on request, with a drip cover for operation in vertical position, shaft end facing down (steel cover)
Terminal box	Composite material or aluminium alloy	<ul style="list-style-type: none"> - IP 55 - can be turned at 90° - fitted with a terminal block with 6 steel terminals as standard (brass as an option) - terminal box fitted with threaded plugs, supplied without cable glands (cable glands as an option) - 1 earth terminal in each terminal box - fixing system consisting of a cover with captive screws

In the standard version, the motors are wound 400 V 50 Hz:

- power ratings ≤ 5.5 kW: Y connection
- power ratings ≥ 7.5 kW: connection D

IMfinity® 3-phase induction motors - IE2 - IE3 - IE4 - Non IE Efficiency

IP55 aluminium frame

Electrical and mechanical characteristics

Non IE efficiency - Powered by the mains

IP55 ALUMINIUM MOTORS

Type	Rated power P _n kW	Rated torque M _n N.m	Starting torque/ Rated torque M _d /M _n	Maximum torque/ Rated torque M _m /M _n	Starting current/ Rated current I _d /I _n	Moment of inertia J kg.m ²	Weight IM B3 kg	Noise LP db(A)	400V 50Hz							
									Rated speed N _n min ⁻¹	Rated current I _n A	Efficiency IEC 60034-2-1 2007 η			Power factor Cos φ		
											4/4	3/4	2/4	4/4	3/4	2/4
2 poles																
LS 56 L *	0.09	0.3	5.5	5.6	4.9	0.00015	3.8	54	2860	0.44	54.0	45.0	37.0	0.55	0.45	0.40
LS 56 L *	0.12	0.4	4.1	4.2	4.6	0.00015	3.8	54	2820	0.50	58.0	54.0	45.0	0.60	0.55	0.45
LS 63 M *	0.18	0.6	3.4	3.0	5.0	0.00019	4.8	57	2790	0.52	67.0	66.0	59.0	0.75	0.65	0.55
LS 63 M *	0.25	0.8	3.4	3.1	5.4	0.00025	6.0	57	2800	0.71	68.0	67.0	59.0	0.75	0.65	0.55
LS 71 L *	0.37	1.3	3.2	3.8	5.2	0.00035	6.4	62	2800	0.98	68.0	67.0	63.0	0.80	0.70	0.60
LS 71 L *	0.55	1.9	3.2	3.1	6.0	0.00045	7.3	62	2800	1.32	75.0	75.0	71.0	0.80	0.70	0.55
LS 71 L *	0.75	2.5	3.6	3.4	6.7	0.00060	9.0	62	2825	1.67	77.6	77.7	74.8	0.83	0.76	0.64
LS 80 L	0.75	2.6	2.2	2.4	5.1	0.00070	8.2	56	2820	1.75	72.1	73.4	71.5	0.85	0.77	0.64
LS 80 L	1.1	3.7	2.4	2.6	5.3	0.00090	9.7	56	2830	2.50	75.0	76.3	74.9	0.84	0.77	0.63
LS 90 SL	1.5	5.0	2.5	3.0	6.1	0.00140	13.5	66	2880	3.35	77.2	77.8	76.3	0.84	0.77	0.66
LS 90 L	2.2	7.3	2.8	2.9	6.1	0.00210	15.6	67	2870	4.65	79.7	81.0	80.3	0.86	0.80	0.69
LS 100 L	3	10.0	2.9	2.9	6.0	0.00220	19.5	70	2860	6.45	81.5	82.7	81.5	0.82	0.75	0.62
LS 100 L	3.7	12.2	3.7	3.9	8.1	0.00290	24.8	66	2905	7.80	82.7	83.2	82.0	0.83	0.76	0.65
LS 112 M	4	13.2	3.6	3.6	7.9	0.00290	24.8	66	2890	8.20	83.1	84.0	83.3	0.85	0.79	0.68
LS 132 S	5.5	18.0	2.3	3.2	7.4	0.00790	35.8	63	2925	11.0	84.7	85.0	83.3	0.85	0.79	0.67
LS 132 S	7.5	24.6	2.4	3.1	7.6	0.00960	39.4	63	2915	14.6	86.0	86.6	85.5	0.86	0.79	0.67
LS 132 M	9	29.3	2.2	3.0	6.6	0.01100	50.7	71	2935	18.0	86.8	87.4	86.6	0.83	0.77	0.66
LS 160 MP	11	35.8	2.2	3.1	6.7	0.01260	61.7	74	2935	22.4	87.6	87.8	86.6	0.81	0.74	0.63
LS 160 MR	15	48.8	2.7	3.3	7.7	0.01500	72.5	75	2935	28.3	88.7	89.3	88.7	0.86	0.82	0.73
LS 160 L	18.5	60.1	2.7	3.4	7.4	0.04400	100	72	2940	35.2	89.3	89.3	88.3	0.85	0.80	0.69
LS 180 MT	22	71.5	2.7	3.2	7.3	0.05200	105	73	2940	41.6	89.9	90.6	90.3	0.85	0.81	0.72
LS 200 LR	30	97.1	3.1	3.6	8.3	0.09010	158	74	2950	55.8	90.7	91.1	90.8	0.86	0.82	0.74
LS 200 L	37	120	2.0	2.8	6.5	0.11700	198	74	2940	67.9	91.2	91.8	91.8	0.86	0.83	0.76
LS 225 MT	45	146	2.3	3.3	7.2	0.13890	200	73	2945	83.3	91.7	92.3	92.3	0.85	0.81	0.73
4 poles																
LS 56 L *	0.09	0.6	2.8	2.8	3.2	0.00025	4.0	47	1400	0.39	55.0	49.6	42.8	0.60	0.52	0.42
LS 63 M *	0.12	0.8	2.5	2.4	3.2	0.00035	4.8	49	1380	0.44	56.0	54.0	46.8	0.70	0.58	0.47
LS 63 M *	0.18	1.2	2.7	2.7	3.7	0.00048	5.0	49	1390	0.64	62.0	58.0	51.0	0.65	0.55	0.44
LS 71 L *	0.25	1.7	2.7	2.9	4.6	0.00068	6.4	49	1425	0.80	69.0	67.0	60.0	0.65	0.56	0.45
LS 71 L *	0.37	2.5	2.4	2.8	4.9	0.00085	7.3	49	1420	1.06	72.0	72.0	66.0	0.70	0.59	0.47
LS 71 L *	0.55	3.8	2.3	2.5	4.8	0.00110	8.3	49	1400	1.62	70.0	70.0	65.0	0.70	0.62	0.49
LS 80 L	0.55	3.8	2.2	2.3	3.9	0.00128	8.5	61	1405	1.70	66.9	64.6	57.3	0.71	0.59	0.46
LS 80 L	0.75	5.1	1.8	2.2	4.3	0.00164	10.5	61	1400	2.05	69.3	68.8	64.0	0.77	0.67	0.53
LS 80 L	0.9	6.1	3.1	3.1	5.6	0.00240	10.9	61	1425	2.45	73.0	73.0	70.0	0.73	0.67	0.54
LS 90 SL	1.1	7.4	1.5	2.2	4.5	0.00265	12.0	49	1425	2.50	76.1	78.4	77.6	0.84	0.77	0.64
LS 90 L	1.5	10.0	1.9	2.4	5.3	0.00337	13.8	49	1430	3.30	79.2	80.8	79.6	0.83	0.75	0.61
LS 90 L	1.8	12.0	2.0	2.6	5.6	0.00380	14.8	54	1435	3.95	79.9	81.3	80.0	0.82	0.74	0.60
LS 100 L	2.2	14.6	2.3	2.7	5.7	0.00430	18.8	53	1435	4.80	80.2	81.6	80.4	0.82	0.74	0.61
LS 100 L	3	20.0	2.6	3.1	6.7	0.00570	22.5	51	1435	6.35	82.2	83.7	83.0	0.83	0.76	0.64
LS 112 M	4	26.7	2.7	3.1	5.9	0.00620	23.0	51	1430	8.95	81.4	82.4	80.6	0.79	0.70	0.55
LS 132 S	5.5	36.1	2.6	3.2	7.0	0.01450	38.0	58	1456	11.5	85.4	85.9	84.5	0.81	0.74	0.60
LS 132 M	7.5	49.4	2.3	3.0	5.9	0.01920	48.0	63	1450	15.6	86.8	87.7	86.9	0.80	0.71	0.56
LS 132 M	9	59.3	2.4	3.0	6.6	0.02280	52.9	63	1450	17.8	87.5	88.9	89.1	0.83	0.77	0.64
LS 160 MP	11	72.3	2.9	3.3	6.9	0.02780	65.6	63	1452	22.1	88.8	89.7	89.3	0.81	0.72	0.58
LS 160 LR	15	98.5	2.9	3.4	7.5	0.03570	78.8	64	1454	30.0	89.1	89.9	89.4	0.81	0.73	0.59
LS 180 MT	18.5	121	2.1	3.2	8.0	0.08440	100	58	1464	36.0	89.3	90.1	90.1	0.83	0.77	0.66
LS 180 LR	22	143	2.6	3.4	8.4	0.09560	108	60	1466	41.9	89.9	90.7	90.6	0.84	0.79	0.68
LS 200 LR	30	196	2.0	2.6	7.6	0.15630	166	64	1464	57.4	90.7	91.6	91.7	0.83	0.78	0.69
LS 225 ST	37	240	2.7	2.7	6.1	0.22940	205	64	1472	71.5	91.2	92.0	92.1	0.82	0.77	0.67
LS 225 MR	45	292	2.3	2.4	6.8	0.28850	230	70	1472	85.3	91.7	92.3	92.3	0.83	0.78	0.68
6 poles																
LS 63 M *	0.09	0.9	1.8	1.8	2.1	0.00060	5.5	48	860	0.46	35.0	32.0	26.0	0.80	0.70	0.63
LS 71 L *	0.12	1.3	2.5	2.6	2.9	0.00070	6.5	52	920	0.64	49.0	45.0	36.0	0.55	0.48	0.40
LS 71 L *	0.18	1.8	1.9	2.0	2.7	0.00110	7.6	52	895	0.81	52.0	50.0	43.0	0.62	0.53	0.43
LS 71 L *	0.25	2.6	1.7	1.7	2.5	0.00130	7.9	52	840	1.00	50.0	52.0	47.0	0.70	0.59	0.48
LS 80 L	0.37	3.7	2.1	2.5	3.9	0.00320	9.7	41	954	1.30	61.7	50.3	50.3	0.66	0.55	0.44
LS 80 L	0.55	5.5	2.6	3.0	3.4	0.00420	11.0	41	956	2.15	61.0	47.4	47.4	0.60	0.50	0.40
LS 90 SL	0.75	7.5	1.9	2.4	3.7	0.00330	14.8	43	952	2.25	70.0	66.8	66.8	0.68	0.58	0.44
LS 90 L	1.1	11.2	1.9	2.2	3.9	0.00380	16.0	56	940	3.05	72.9	72.2	72.2	0.71	0.61	0.47
LS 100 L	1.5	15.4	2.0	2.3	3.8	0.00437	13.8	70	930	4.00	75.2	76.0	76.0	0.72	0.62	0.48
LS 112 MG	2.2	21.9	2.1	2.4	4.8	0.01520	30.4	50	960	5.60	77.7	78.0	78.0	0.73	0.65	0.52
LS 132 S	3	29.8	2.4	2.7	5.0	0.01920	38.4	49	960	7.65	79.7	79.8	79.8	0.71	0.63	0.50
LS 132 M	4	39.6	2.2	2.6	5.4	0.02528	23.0	53	964	9.25	81.4	82.6	82.6	0.77	0.71	0.59
LS 132 M	5.5	54.4	2.6	2.8	5.6	0.03027	38.0	58	966	13.1	83.1	83.7	83.7	0.73	0.66	0.53
LS 160 M	7.5	73.5	1.7	2.7	5.2	0.08840	48.0	59	974	17.2	84.7	83.3	83.3	0.74	0.66	0.53
LS 160 L	11	109	1.9	2.6	5.3	0.11600	65.6	59	966	23.6	86.4	86.6	86.6	0.78	0.70	0.57
LS 180 LR	15	149	1.8	2.5	4.8	0.13900	78.8	59	960	31.9	87.0	88.2	88.2	0.78	0.73	0.61
LS 200 LR	18.5	181	2.6	2.9	6.7	0.25000	100	58	974	37.7	88.6	89.7	89.7	0.80	0.75	0.64

* non IMfinity® generation

IMfinity® 3-phase induction motors - IE2 - IE3 - IE4 - Non IE Efficiency

IP55 aluminium frame

Electrical and mechanical characteristics

Non IE efficiency - Powered by the mains

Type	Rated power P_n kW	380V 50Hz				415V 50Hz				460V 60Hz				
		Rated speed N_n min ⁻¹	Rated current I_n A	Efficiency η 4/4	Power factor $\cos \phi$ 4/4	Rated speed N_n min ⁻¹	Rated current I_n A	Efficiency η 4/4	Power factor $\cos \phi$ 4/4	Rated power P_n kW	Rated speed N_n min ⁻¹	Rated current I_n A	Efficiency η 4/4	Power factor $\cos \phi$ 4/4
		N_n min ⁻¹	I_n A	η 4/4	$\cos \phi$ 4/4	N_n min ⁻¹	I_n A	η 4/4	$\cos \phi$ 4/4	P_n kW	N_n min ⁻¹	I_n A	η 4/4	$\cos \phi$ 4/4
2 poles														
LS 56 L *	0.09	2850	0.42	56.0	0.60	2870	0.49	51.0	0.50	0.11	3450	0.47	59.0	0.50
LS 56 L *	0.12	2800	0.47	60.0	0.65	2830	0.50	56.0	0.60	0.15	3400	0.47	61.0	0.65
LS 63 M *	0.18	2750	0.53	65.0	0.80	2800	0.55	65.0	0.70	0.22	3400	0.53	69.0	0.75
LS 63 M *	0.25	2750	0.73	65.0	0.80	2810	0.74	67.0	0.70	0.30	3420	0.65	72.0	0.80
LS 71 L *	0.37	2780	0.97	68.0	0.85	2820	0.95	68.0	0.80	0.44	3380	0.93	70.0	0.85
LS 71 L *	0.55	2750	1.33	74.0	0.85	2810	1.36	75.0	0.75	0.66	3380	1.34	77.0	0.80
LS 71 L *	0.75	2800	1.69	77.9	0.87	2840	1.66	78.5	0.80	0.90	3410	1.67	79.9	0.85
LS 80 L	0.75	2790	1.85	70.6	0.88	2840	1.75	72.6	0.82	0.86	3425	1.70	74.7	0.84
LS 80 L	1.1	2800	2.60	74.1	0.87	2845	2.50	75.4	0.81	1.27	3435	2.45	77.3	0.84
LS 90 SL	1.5	2860	3.45	76.4	0.86	2890	3.35	77.5	0.81	1.73	3475	3.30	78.0	0.85
LS 90 L	2.2	2855	4.85	79.0	0.87	2890	4.65	80.3	0.82	2.53	3465	4.60	80.5	0.86
LS 100 L	3	2835	6.60	80.7	0.86	2870	6.45	81.4	0.79	3.45	3455	6.25	82.8	0.84
LS 100 L	3.7	2890	7.90	82.5	0.86	2910	7.75	82.8	0.80	4.26	3505	7.55	83.6	0.85
LS 112 M	4	2875	8.35	82.5	0.88	2900	8.15	83.3	0.82	4.60	3485	7.95	84.0	0.86
LS 132 S	5.5	2910	11.1	84.4	0.89	2930	11.0	84.6	0.82	6.33	3520	10.6	85.2	0.88
LS 132 S	7.5	2900	15.0	85.5	0.89	2925	15.2	85.7	0.80	8.63	3520	14.3	86.7	0.87
LS 132 M	9	2925	18.4	86.4	0.86	2940	18.3	86.7	0.79	10.35	3535	17.8	87.3	0.84
LS 160 MP	11	2930	22.3	87.5	0.86	2945	22.7	87.5	0.77	12.65	3540	21.5	88.1	0.84
LS 160 MR	15	2925	29.1	88.1	0.89	2945	27.9	89.0	0.84	17.25	3540	27.7	89.0	0.88
LS 160 L	18.5	2935	35.5	89.0	0.89	2945	35.6	89.4	0.81	21.28	3545	34.2	89.6	0.87
LS 180 MT	22	2930	42.6	89.3	0.88	2945	41.0	90.2	0.83	25.30	3535	40.5	90.2	0.87
LS 200 LR	30	2945	57.6	90.2	0.88	2954	54.5	90.9	0.84	34.50	3550	55.0	90.7	0.87
LS 200 L	37	2925	70.8	90.3	0.87	2945	67.0	91.2	0.84	42.55	3540	67.5	90.9	0.87
LS 225 MT	45	2935	86.4	91.2	0.87	2950	81.8	91.8	0.83	51.75	3545	82.2	92.1	0.86
4 poles														
LS 56 L *	0.09	1380	0.38	56.0	0.65	1410	0.40	52.0	0.60	0.11	1700	0.36	62.0	0.60
LS 63 M *	0.12	1365	0.47	56.0	0.70	1390	0.46	56.0	0.65	0.15	1680	0.46	59.0	0.70
LS 63 M *	0.18	1375	0.68	62.0	0.65	1400	0.68	61.0	0.60	0.22	1690	0.64	65.0	0.65
LS 71 L *	0.25	1425	0.78	70.0	0.70	1430	0.84	69.0	0.60	0.30	1720	0.76	71.0	0.70
LS 71 L *	0.37	1410	1.10	73.0	0.70	1430	1.10	72.0	0.65	0.44	1720	1.06	75.0	0.70
LS 71 L *	0.55	1385	1.59	70.0	0.75	1410	1.56	70.0	0.70	0.66	1700	1.51	73.0	0.75
LS 80 L	0.55	1390	1.65	67.5	0.75	1415	1.75	65.5	0.67	0.63	1710	1.40	71.6	0.70
LS 80 L	0.75	1380	2.05	68.3	0.81	1410	2.05	69.0	0.73	0.86	1705	1.95	73.3	0.76
LS 80 L	0.9	1415	2.45	73.0	0.77	1435	2.50	72.0	0.70	1.04	1715	2.20	75.5	0.78
LS 90 SL	1.1	1420	3.40	77.8	0.86	1440	3.25	79.5	0.80	1.27	1730	2.40	78.8	0.84
LS 90 L	1.5	1425	4.10	78.8	0.85	1445	4.00	80.3	0.78	1.73	1735	3.20	81.2	0.83
LS 90 L	1.8	1410	2.60	74.3	0.87	1435	2.45	77.0	0.82	2.07	1735	3.90	81.8	0.82
LS 100 L	2.2	1425	4.90	79.3	0.86	1445	4.90	80.6	0.78	2.53	1735	4.70	82.4	0.82
LS 100 L	3	1425	6.50	81.3	0.86	1440	6.30	82.7	0.80	3.45	1735	6.15	83.8	0.84
LS 112 M	4	1420	8.90	80.9	0.84	1440	9.10	81.4	0.75	4.60	1735	8.70	83.4	0.80
LS 132 S	5.5	1440	11.5	84.5	0.86	1456	11.2	85.5	0.81	6.33	1756	11.0	86.7	0.83
LS 132 M	7.5	1445	15.9	86.5	0.83	1415	14.3	85.5	0.67	8.63	1740	14.8	87.9	0.83
LS 132 M	9	1440	18.4	86.5	0.86	1410	16.9	69.0	0.73	10.35	1745	17.2	88.7	0.85
LS 160 MP	11	1450	22.8	88.5	0.83	1435	20.6	72.0	0.70	12.65	1745	20.8	89.7	0.85
LS 160 LR	15	1450	31.0	88.7	0.83	1440	27.8	79.5	0.80	17.25	1745	28.4	89.8	0.85
LS 180 MT	18.5	1450	36.9	88.8	0.86	1445	34.9	80.3	0.78	21.28	1762	34.5	92.1	0.84
LS 180 LR	22	1460	43.1	89.2	0.87	1435	40.8	77.0	0.82	25.30	1768	40.4	92.7	0.85
LS 200 LR	30	1458	58.4	91.4	0.85	1445	55.6	80.6	0.78	34.50	1764	55.0	92.9	0.85
LS 225 ST	37	1472	73.9	90.6	0.84	1440	65.3	82.7	0.80	42.55	1776	68.9	93.4	0.83
LS 225 MR	45	1466	88.8	92.2	0.84	1440	78.4	81.4	0.75	51.75	1770	82.6	93.6	0.84
6 poles														
LS 63 M *	0.09	840	0.47	35.0	0.84	880	0.46	34.0	0.80	0.11	1060	0.44	45.0	0.70
LS 71 L *	0.12	910	0.62	50.0	0.59	925	0.67	47.0	0.53	0.14	1120	0.60	53.0	0.55
LS 71 L *	0.18	850	0.82	50.0	0.67	895	0.82	51.0	0.60	0.22	1100	0.79	58.0	0.60
LS 71 L *	0.25	830	1.09	49.0	0.71	890	1.05	52.0	0.64	0.30	1080	1.00	57.0	0.66
LS 80 L	0.37	945	1.25	63.1	0.70	958	1.35	60.8	0.63	0.43	1154	1.25	66.6	0.64
LS 80 L	0.55	952	2.05	63.7	0.64	960	2.35	57.9	0.56	0.63	1156	2.00	66.9	0.59
LS 90 SL	0.75	945	2.25	69.9	0.72	956	2.30	70.1	0.65	0.86	1154	2.25	72.8	0.67
LS 90 L	1.1	930	3.10	71.7	0.75	945	3.05	73.0	0.68	1.27	1145	3.00	75.8	0.70
LS 100 L	1.5	915	4.05	73.8	0.76	935	4.05	75.5	0.68	1.73	1135	3.85	78.6	0.72
LS 112 MG	2.2	952	5.85	76.5	0.75	962	5.60	77.9	0.71	2.53	1160	5.50	79.5	0.73
LS 132 S	3	954	7.80	78.8	0.74	964	7.65	79.9	0.68	3.45	1160	7.50	81.6	0.71
LS 132 M	4	956	9.60	80.0	0.80	966	9.15	81.6	0.75	4.60	1162	9.10	82.5	0.77
LS 132 M	5.5	960	13.4	82.5	0.75	970	13.5	83.4	0.68	6.33	1158	12.4	83.9	0.76
LS 160 M	7.5	970	17.3	84.4	0.78	976	17.4	84.5	0.71	8.63	1174	16.6	85.9	0.76
LS 160 L	11	960	24.1	85.4	0.81	968	23.6	86.4	0.75	12.65	1162	22.0	87.8	0.82
LS 180 LR	15	952	32.3	86.0	0.82	964	31.4	87.3	0.76	17.25	1150	31.4	87.2	0.79
LS 200 LR	18.5	968	39.3	87.8	0.82	976	36.8	89.0	0.78	21.28	1174	36.9	89.3	0.81

* non IMfinity® generation

IMfinity® 3-phase induction motors - IE2 - IE3 - IE4 - Non IE Efficiency

IP55 aluminium frame

Electrical and mechanical characteristics

IE2 powered by the mains

IP55 ALUMINIUM MOTORS

Type	Rated power P _n kW	Rated torque M _n N.m	Starting torque/ Rated torque M _d /M _n	Maximum torque/ Rated torque M _m /M _n	Starting current/ Rated current I _d /I _n	Moment of inertia J kg.m ²	Weight IM B3 kg	Noise LP db(A)	400V 50Hz							
									Rated speed N _n min ⁻¹	Rated current I _n A	Efficiency IEC 60034-2-1 2007 η			Power factor Cos φ		
											4/4	3/4	2/4	4/4	3/4	2/4
2 poles																
LSES 80 L	0.75	2.5	3.0	3.2	6.4	0.00084	9.7	56	2850	1.6	79.5	80.4	78.9	0.85	0.78	0.66
LSES 80 L	1.1	3.7	2.5	3.1	6.7	0.00095	9.9	57	2850	2.3	80.7	82.0	81.0	0.85	0.78	0.65
LSES 90 SL	1.5	5	2.2	2.9	6.4	0.00201	14.4	63	2865	3	83.7	85.8	86.1	0.86	0.80	0.68
LSES 90 L	1.8	6	3.0	3.1	6.9	0.00223	15.6	63	2885	3.9	83.4	84.8	84.6	0.84	0.78	0.66
LSES 90 L	2.2	7.4	2.7	2.9	6.2	0.00223	15.6	64	2860	4.4	83.7	85.8	86.1	0.86	0.80	0.68
LSES 100 L	3	10	4.4	3.9	8.0	0.00297	21.5	67	2855	5.9	85.3	86.4	85.7	0.86	0.79	0.67
LSES 100 L	3.7	12.3	3.0	3.2	7.2	0.00364	35.2	67	2875	7.15	85.8	87.4	87.7	0.87	0.82	0.71
LSES 112 M	4	13.3	3.4	3.0	7.4	0.00364	24.4	66	2875	7.85	86.1	87.7	87.7	0.85	0.79	0.67
LSES 132 S	5.5	18	2.4	3.2	7.7	0.00967	35.6	72	2920	10.5	87.7	88.5	87.7	0.86	0.81	0.70
LSES 132 SU	7.5	24.5	2.5	3.3	7.8	0.01207	42.7	71	2920	14.3	88.5	89.4	89.1	0.86	0.81	0.70
LSES 132 M	9	29.3	2.1	2.9	6.6	0.01102	55.5	67	2930	16.8	90.2	91.3	91.4	0.86	0.82	0.73
LSES 160 MP	11	35.8	2.4	3.1	6.9	0.01263	65	71	2935	21.1	90.4	91.1	90.7	0.83	0.77	0.67
LSES 160 MR	15	48.8	2.4	3.2	7.3	0.01506	76.1	73	2935	28.2	90.6	91.3	91.0	0.85	0.80	0.70
LSES 160 L	18.5	60	2.7	3.0	8.2	0.049	100	69	2945	32.8	92.3	93.1	93.2	0.88	0.85	0.77
LSES 180 MT	22	71.6	2.6	2.6	7.4	0.0554	100	68	2935	39.4	92.0	93.0	93.3	0.88	0.85	0.78
LSES 200 LR	30	97.1	3.1	3.6	8.5	0.0929	158	74	2950	54.4	93.0	93.4	93.1	0.86	0.82	0.74
LSES 200 L	37	120	2.0	2.8	6.6	0.2492	198	74	2940	66.4	93.3	93.9	93.9	0.86	0.83	0.76
LSES 225 MT	45	146	2.3	3.3	7.3	0.1389	200	73	2945	81.7	93.5	94.1	94.1	0.85	0.81	0.73
LSES 250 MZ	55	178	2.5	3.5	8.0	0.1754	234	72	2945	96.1	94.0	94.6	94.6	0.88	0.85	0.79
LSES 280 SC	75	241	2.3	3.3	8.0	0.4092	350	79	2970	127	94.4	94.6	94.3	0.90	0.88	0.82
LSES 280 MC	90	289	2.5	3.6	8.4	0.476	382	80	2972	152	94.7	95.0	94.7	0.90	0.88	0.82
LSES 315 SN	110	354	2.6	3.1	8.0	0.5343	452	79	2968	186	95.0	95.4	95.3	0.90	0.88	0.84
LSES 315 MP	132	423	2.3	3.2	7.7	0.5784	470	79	2978	228	95.2	95.2	94.6	0.88	0.86	0.80
LSES 315 MP	160	513	2.2	3.3	7.7	1.2646	705	80	2978	275	95.4	95.5	93.9	0.88	0.86	0.80
LSES 315 MP	200	642	2.2	3.5	7.8	1.3841	770	80	2974	342	95.6	95.8	95.5	0.88	0.86	0.80
4 poles																
LSES 80 LG	0.75	5	1.9	2.8	5.9	0.00265	11.6	47	1445	1.7	80.9	81.5	80.1	0.78	0.70	0.57
LSES 80 LG	0.9	6	1.9	2.5	6.3	0.00316	14.1	47	1435	1.95	80.5	81.5	79.8	0.82	0.60	0.74
LSES 90 SL	1.1	7.3	1.9	2.7	6.1	0.00336	13.9	47	1440	2.35	82.1	83.8	83.5	0.82	0.74	0.61
LSES 90 L	1.5	10	2.3	2.9	6.3	0.00418	16.2	47	1440	3.15	83.5	85.1	84.7	0.82	0.75	0.62
LSES 90 LU	1.8	11.9	2.6	2.3	6.6	0.0045	20.4	47	1440	3.8	83.9	84.4	82.8	0.81	0.72	0.57
LSES 100 L	2.2	14.6	2.5	3.1	6.8	0.00567	22.6	49	1440	4.5	85.0	86.3	85.9	0.83	0.76	0.64
LSES 100 LR	3	19.9	2.8	3.2	6.7	0.00677	25.8	54	1440	6.25	85.8	87.1	86.8	0.81	0.73	0.60
LSES 112 MU	4	26.4	2.2	3.0	6.2	0.01312	34.4	55	1445	7.9	87.2	88.9	89.3	0.84	0.78	0.67
LSES 132 SU	5.5	36.1	2.7	3.1	7.1	0.01611	42.1	55	1454	11.2	88.5	89.5	89.2	0.80	0.73	0.60
LSES 132 M	7.5	49.3	2.6	3.4	7.5	0.02286	52.1	60	1452	14.4	89.4	90.5	90.5	0.84	0.78	0.66
LSES 132 M	9	58.9	2.8	3.6	8.0	0.02722	59.1	63	1458	17.1	90.0	91.0	91.0	0.84	0.78	0.66
LSES 160 MR	11	71.9	3.1	3.7	8.4	0.03574	78	61	1460	20.9	90.6	91.5	91.3	0.84	0.78	0.66
LSES 160 L	15	97.8	2.5	3.1	8.1	0.0712	90	60	1464	28.2	91.2	92.1	92.1	0.84	0.79	0.67
LSES 180 MT	18.5	121	2.1	3.2	8.2	0.0844	100	58	1464	35.2	91.4	92.3	92.2	0.83	0.77	0.66
LSES 180 LR	22	143	2.6	3.4	8.6	0.0956	108	60	1466	41	91.9	92.7	92.6	0.84	0.79	0.68
LSES 200 LR	30	196	2.0	2.6	7.8	0.1563	166	64	1464	56.3	92.4	93.3	93.4	0.83	0.78	0.69
LSES 225 ST	37	240	2.7	2.7	6.3	0.2294	205	64	1472	70.2	92.9	93.7	93.8	0.82	0.77	0.67
LSES 225 MR	45	292	2.3	2.4	6.9	0.2885	230	70	1472	83.8	93.4	94.1	94.0	0.83	0.78	0.68
LSES 250 ME	55	354	2.3	2.7	7.3	0.7793	350	69	1484	101	94.7	95.1	95.0	0.83	0.79	0.70
LSES 280 SD	75	482	2.5	3.2	8.2	0.9595	428	69	1486	138	94.5	94.7	94.4	0.83	0.79	0.69
LSES 280 MD	90	579	2.6	3.5	8.3	1.0799	470	68	1484	169	94.7	94.9	94.6	0.81	0.76	0.65
LSES 315 SP	110	706	3.1	2.9	7.6	2.4322	690	76	1488	200	94.8	94.8	94.3	0.84	0.80	0.70
LSES 315 MP	132	848	3.1	2.8	7.3	3.223	740	76	1486	236	95.0	95.2	94.8	0.85	0.81	0.72
LSES 315 MP	160	1030	2.6	2.8	7.2	3.223	740	76	1486	293	95.0	95.1	94.6	0.83	0.78	0.68
LSES 315 MR	200	1290	3.0	2.9	7.3	3.2324	820	76	1486	366	95.5	95.7	95.3	0.83	0.78	0.68
6 poles																
LSES 90 SL	0.75	7.5	1.9	2.4	4.1	0.00338	14.8	43	952	2.05	76.6	76.7	73.6	0.68	0.58	0.46
LSES 90 L	1.1	11.2	1.9	2.3	4.3	0.00437	17.8	53	940	2.8	79.2	80.7	79.7	0.71	0.62	0.49
LSES 100 L	1.5	15.2	2.0	2.4	4.3	0.00602	24.8	53	945	3.9	80.6	81.8	80.6	0.69	0.60	0.47
LSES 112 MG	2.2	21.9	2.1	2.4	5.0	0.01523	30.4	50	960	5.3	82.0	83.2	82.3	0.73	0.65	0.52
LSES 132 S	3	29.8	2.4	2.7	5.3	0.01922	38.4	49	960	7.3	83.4	84.5	83.5	0.71	0.63	0.50
LSES 132 M	4	39.6	2.2	2.6	5.6	0.02528	47.7	53	964	8.8	85.5	86.9	86.8	0.77	0.71	0.59
LSES 132 M	5.5	54.4	2.6	2.8	5.8	0.03027	54	53	966	12.6	86.2	87.3	86.8	0.73	0.66	0.53
LSES 160 M	7.5	73.5	1.7	2.7	5.4	0.0912	82	59	974	16.6	87.9	88.1	86.4	0.74	0.66	0.53
LSES 160 LUR	11	108	1.9	2.7	5.9	0.1378	105	57	974	23.7	89.2	89.5	88.3	0.75	0.68	0.55
LSES 180 L	15	147	2.6	2.9	7.3	0.2048	140	62	976	29.6	90.0	90.9	90.7	0.81	0.76	0.65
LSES 200 LR	18.5	181	2.6	2.9	6.9	0.2538	165	62	974	36.7	90.8	91.8	91.9	0.80	0.75	0.64
LSES 200 L	22	216	1.8	2.5	6.1	0.33	200	62	974	42.5	91.1	92.2	92.5	0.82	0.79	0.70
LSES 225 MR	30	293	2.9	3.2	7.6	0.3915	222	65	978	62.7	92.0	92.4	91.8	0.75	0.70	0.59
LSES 250 ME	37	360	2.2	2.4	6.1	0.9234	310	64	982	68	92.5	93.0	92.9	0.85	0.81	0.72
LSES 280 SC	45	438	2.2	2.5	6.2	1.1279	377	64	982	84.3	92.9	93.5	93.3	0.83	0.78	0.68
LSES 280 MC	55	534	2.4	2.7	6.5	1.3995	444	59	984	103	93.3	93.8	93.6	0.83	0.79	0.68
LSES 315 SP	75	723	3.0	2.6	7.4	2.8937	630	71	990	148	94.0	94.1	93.3	0.78	0.73	0.61
LSES 315 MP	90	868	3.1	2.7	7.8	3.4127	700	75	990	172	94.5	94.5	93.7	0.80	0.75	0.64
LSES 315 MR	110	1060	3.0	2.1	7.4	3.0776	770	73	990	209	94.8	95.0	94.5	0.80	0.76	0.66
LSES 315 MR	132	1270	2.7	2.2	7.1	4.6331	860	76	990	252	95.0	95.2	94.8	0.80	0.76	0.66

IMfinity® 3-phase induction motors - IE2 - IE3 - IE4 - Non IE Efficiency

IP55 aluminium frame

Electrical and mechanical characteristics

IE2 powered by the mains

Type	Rated power P _n kW	380V 50Hz				415V 50Hz				460V 60Hz			
		Rated speed	Rated current	Efficiency	Power factor	Rated speed	Rated current	Efficiency	Power factor	Rated speed	Rated current	Efficiency	Power factor
		N _n min ⁻¹	I _n A	η 4/4	Cos φ 4/4	N _n min ⁻¹	I _n A	η 4/4	Cos φ 4/4	N _n min ⁻¹	I _n A	η 4/4	Cos φ 4/4
2 poles													
LSES 80 L	0.75	2830	1.65	78.7	0.87	2865	1.6	79.6	0.83	3475	1.4	80.9	0.82
LSES 80 L	1.1	2825	2.4	79.6	0.87	2865	2.3	81.0	0.83	3475	2	83.2	0.83
LSES 90 SL	1.5	2825	4.55	83.2	0.88	2870	4.3	84.6	0.84	3485	3.8	86.5	0.84
LSES 90 L	1.8	2865	4.05	82.3	0.87	2900	3.85	83.9	0.81	3495	3.2	84.4	0.84
LSES 90 L	2.2	2825	4.55	83.2	0.88	2870	4.3	84.6	0.84	3485	3.8	86.5	0.84
LSES 100 L	3	2830	6.15	84.6	0.88	2875	5.85	85.8	0.83	3485	5.15	86.8	0.84
LSES 100 L	3.7	2860	7.55	85.5	0.88	2890	7.05	86.6	0.84	3500	6.3	86.6	0.85
LSES 112 M	4	2850	8.05	85.8	0.87	2885	7.75	86.6	0.83	3500	6.8	88.1	0.83
LSES 132 S	5.5	2905	10.8	87.0	0.88	2930	10.4	87.9	0.83	3535	9.15	88.8	0.85
LSES 132 SU	7.5	2905	14.6	88.1	0.88	2925	14.1	88.7	0.83	3535	12.4	89.6	0.85
LSES 132 M	9	2920	17.6	89.4	0.87	2940	16.5	90.6	0.84	3540	14.6	91.4	0.85
LSES 160 MP	11	2930	21.8	90.0	0.85	2945	21.1	90.6	0.80	3550	18.3	91.5	0.83
LSES 160 MR	15	2920	29	90.3	0.87	2935	28	90.7	0.82	3545	24.4	91.4	0.85
LSES 160 L	18.5	2935	34.4	91.6	0.89	2950	32.2	92.6	0.86	3554	28.5	93.2	0.88
LSES 180 MT	22	2925	41.1	91.3	0.89	2945	38.3	92.5	0.87	3545	33.8	93.3	0.87
LSES 200 LR	30	2945	56.2	92.5	0.88	2954	53.1	93.2	0.84	3558	47.1	93.3	0.86
LSES 200 L	37	2925	69.1	92.5	0.87	2945	65.5	93.3	0.84	3552	57.7	93.5	0.86
LSES 225 MT	45	2935	84.7	93.0	0.87	2950	80.2	93.6	0.83	3558	70.7	94.2	0.85
LSES 250 MZ	55	2940	100	93.4	0.89	2954	93.9	94.2	0.87	3560	83.1	94.6	0.88
LSES 280 SC	75	2964	134	94.0	0.91	2974	124	94.6	0.89	3574	111	94.4	0.90
LSES 280 MC	90	2968	159	94.5	0.91	2972	149	94.8	0.89	3574	132	94.8	0.90
LSES 315 SN	110	2962	196	94.6	0.91	2970	180	95.1	0.89	3574	162	95.2	0.90
LSES 315 MP	132	2974	238	95.0	0.89	2984	221	95.3	0.87	3580	199	95.0	0.88
LSES 315 MP	160	2976	287	95.2	0.89	2980	268	95.5	0.87	3580	240	95.2	0.88
LSES 315 MP	200	2970	359	95.4	0.89	2980	336	95.7	0.86	3580	298	95.7	0.88
4 poles													
LSES 80 LG	0.75	1435	1.75	79.7	0.82	1450	1.7	80.77	0.76	1754	1.5	82.9	0.75
LSES 80 LG	0.9	1430	2.05	80.3	0.84	1440	1.95	80.70	0.80	1750	1.75	82.5	0.79
LSES 90 SL	1.1	1430	2.45	81.4	0.84	1445	2.35	82.53	0.80	1750	2.05	84.9	0.79
LSES 90 L	1.5	1430	3.25	82.8	0.85	1445	3.1	84.09	0.80	1752	2.75	86.2	0.79
LSES 90 LU	1.8	1435	3.95	82.8	0.84	1445	3.75	84.10	0.79	1756	3.3	86.8	0.79
LSES 100 L	2.2	1435	4.65	84.3	0.85	1450	4.45	85.56	0.81	1754	3.95	87.5	0.80
LSES 100 LR	3	1430	6.35	85.5	0.84	1445	6.2	86.07	0.78	1752	5.45	87.9	0.78
LSES 112 MU	4	1435	8.3	86.6	0.85	1450	7.75	87.74	0.82	1756	6.8	89.7	0.82
LSES 132 SU	5.5	1445	11.4	87.9	0.83	1458	11.2	88.62	0.77	1762	9.75	90.5	0.78
LSES 132 M	7.5	1445	14.8	88.7	0.86	1458	14.3	89.66	0.81	1762	12.6	91.1	0.82
LSES 132 M	9	1450	17.7	89.4	0.87	1460	16.9	90.30	0.82	1764	15	91.6	0.83
LSES 160 MR	11	1452	21.5	89.9	0.87	1462	20.6	90.82	0.82	1766	18.3	91.7	0.83
LSES 160 L	15	1460	29.1	90.6	0.86	1468	27.8	91.50	0.82	1772	24.6	92.8	0.83
LSES 180 MT	18.5	1460	36	91.2	0.86	1468	34.9	91.59	0.81	1770	30.5	93.0	0.82
LSES 180 LR	22	1460	42	91.6	0.87	1468	40.8	91.92	0.81	1772	35.6	93.2	0.83
LSES 200 LR	30	1458	57.9	92.3	0.85	1468	55.6	92.72	0.81	1772	48.9	93.7	0.82
LSES 225 ST	37	1472	72.2	92.7	0.84	1478	65.3	93.00	0.80	1782	60.8	94.1	0.81
LSES 225 MR	45	1466	86.2	93.1	0.85	1474	78.4	93.57	0.81	1776	72.5	94.4	0.82
LSES 250 ME	55	1482	105	94.3	0.84	1486	98.5	94.93	0.82	1786	88	95.2	0.82
LSES 280 SD	75	1484	143	94.1	0.85	1486	135	94.64	0.81	1786	121	94.9	0.82
LSES 280 MD	90	1482	174	94.5	0.83	1488	167	94.70	0.79	1788	149	95.1	0.80
LSES 315 SP	110	1486	207	94.6	0.85	1488	194	95.03	0.82	1790	177	94.5	0.83
LSES 315 MP	132	1484	244	94.7	0.86	1488	230	95.00	0.84	1790	207	95.0	0.84
LSES 315 MP	160	1484	301	94.9	0.85	1488	292	94.89	0.81	1790	256	95.2	0.82
LSES 315 MR	200	1484	375	95.1	0.85	1488	360	95.41	0.81	1790	318	95.8	0.82
6 poles													
LSES 90 SL	0.75	945	2.05	76.1	0.72	956	2.1	76.2	0.65	-	-	-	-
LSES 90 L	1.1	930	2.85	78.1	0.74	945	2.85	79.5	0.68	-	-	-	-
LSES 100 L	1.5	930	3.95	79.8	0.73	950	3.9	80.7	0.66	-	-	-	-
LSES 112 MG	2.2	952	5.45	81.8	0.75	962	5.3	82.2	0.71	-	-	-	-
LSES 132 S	3	954	7.4	83.3	0.74	964	7.35	83.7	0.68	-	-	-	-
LSES 132 M	4	956	9.05	84.6	0.80	966	8.7	85.8	0.75	-	-	-	-
LSES 132 M	5.5	960	12.9	86.0	0.75	970	13	86.5	0.68	-	-	-	-
LSES 160 M	7.5	970	16.7	87.6	0.78	976	16.8	87.7	0.71	-	-	-	-
LSES 160 LUR	11	972	24.2	88.9	0.78	976	23.6	89.2	0.73	-	-	-	-
LSES 180 L	15	972	30.7	89.7	0.83	978	29.2	90.3	0.79	-	-	-	-
LSES 200 LR	18.5	968	38.2	90.4	0.82	976	35.9	91.2	0.78	-	-	-	-
LSES 200 L	22	968	44.1	90.9	0.83	976	41.2	91.6	0.81	-	-	-	-
LSES 225 MR	30	970	61.4	91.7	0.81	982	59.3	91.9	0.72	-	-	-	-
LSES 250 ME	37	984	70.3	92.2	0.86	988	68.1	92.7	0.82	-	-	-	-
LSES 280 SC	45	982	86.9	92.7	0.85	984	83.5	93.1	0.80	-	-	-	-
LSES 280 MC	55	980	105	93.1	0.85	986	101	93.2	0.81	-	-	-	-
LSES 315 SP	75	990	151	93.9	0.80	992	146	94.3	0.76	-	-	-	-
LSES 315 MP	90	990	178	94.3	0.82	992	170	94.4	0.78	-	-	-	-
LSES 315 MR	110	988	216	94.5	0.82	992	205	95.1	0.78	-	-	-	-
LSES 315 MR	132	990	261	94.8	0.81	990	247	95.0	0.78	-	-	-	-

IMfinity® 3-phase induction motors - IE2 - IE3 - IE4 - Non IE Efficiency

IP55 aluminium frame

Electrical and mechanical characteristics

IE2 powered by the drive

IP55 ALUMINIUM MOTORS

Type	400V 50Hz				% Rated torque M _n at					400V 87Hz Δ ¹				Speed mechanical maximum ²
	Rated power	Rated speed	Rated current	Power factor	10Hz	17Hz	25Hz	50Hz	87Hz	Rated power	Rated speed	Rated current	Power factor	
	P _n kW	N _n min ⁻¹	I _n A	Cos φ 4/4						P _n kW	N _n min ⁻¹	I _n A	Cos φ 4/4	
2 poles														
LSES 80 L	0.75	2800	1.65	0.85	90%	100%	100%	100%	57%	1.31	5020	2.88	0.85	13500
LSES 80 L	1.1	2785	2.5	0.85	85%	100%	100%	100%	57%	1.91	5005	4.32	0.85	13500
LSES 90 SL	1.5	2800	3.2	0.87	85%	100%	100%	100%	57%	2.61	5020	5.59	0.87	11700
LSES 90 L	1.8	2900	3.9	0.84	85%	100%	100%	100%	57%	3.13	5085	6.86	0.84	11700
LSES 90 L	2.2	2775	4.8	0.86	85%	100%	100%	100%	57%	3.83	4995	8.38	0.86	11700
LSES 100 L	3	2790	6.2	0.86	85%	100%	100%	100%	57%	5.22	5010	10.84	0.86	9900
LSES 100 L	3.7	2905	7.15	0.87	85%	100%	100%	100%	57%	6.64	5070	13.37	0.87	9900
LSES 112 M	4	2810	8.3	0.85	85%	100%	100%	100%	57%	6.96	5030	14.47	0.85	9900
LSES 132 S	5.5	2890	11.1	0.86	85%	100%	100%	100%	57%	9.57	5110	19.3	0.86	7600
LSES 132 SU	7.5	2885	15.1	0.86	85%	95%	100%	100%	57%	13.05	5105	26.24	0.86	7600
LSES 132 M	9	2900	17.8	0.86	85%	95%	100%	100%	57%	15.66	5120	30.98	0.86	6700
LSES 160 MP	11	2915	21.9	0.83	85%	95%	100%	100%	57%	19.14	5135	38.09	0.83	6700
LSES 160 MR	15	2900	29.7	0.85	85%	95%	100%	100%	57%	26.1	5120	51.64	0.85	6700
LSES 160 L	18.5	2920	35.6	0.88	85%	95%	100%	100%	57%	32.19	5140	61.96	0.88	6030
LSES 180 MT	21.1	2905	40.8	0.88	82%	91%	96%	100%	55%	36.77	5125	71.06	0.88	5670
LSES 200 LR	30	2930	57.1	0.86	85%	90%	100%	100%	-	-	-	-	-	4500
LSES 200 L	34.2	2910	65.5	0.86	74%	83%	92%	92%	-	-	-	-	-	4500
LSES 225 MT	41.5	2920	79.7	0.85	74%	83%	92%	92%	-	-	-	-	-	4320
LSES 250 MZ	50.5	2925	93.8	0.88	73%	83%	92%	92%	-	-	-	-	-	4320
LSES 280 SC	75	2966	135	0.90	85%	90%	100%	100%	-	-	-	-	-	4320
LSES 280 MC	90	2960	163	0.90	85%	90%	100%	100%	-	-	-	-	-	4320
LSES 315 SN	110	2954	200	0.90	85%	90%	100%	100%	-	-	-	-	-	3600
LSES 315 MP	132	2972	238	0.88	80%	90%	100%	100%	-	-	-	-	-	3600
LSES 315 MP	160	2972	291	0.88	80%	90%	100%	100%	-	-	-	-	-	3600
LSES 315 MP	176	2968	319	0.88	71%	79%	88%	88%	-	-	-	-	-	3600
4 poles														
LSES 80 LG	0.75	1425	1.75	0.78	90%	100%	100%	100%	57%	1.31	2535	3.05	0.78	11700
LSES 80 LG	0.9	1400	1.95	0.82	90%	100%	100%	100%	57%	1.57	2510	3.64	0.82	11700
LSES 90 SL	1.1	1415	2.5	0.82	90%	100%	100%	100%	57%	1.91	2525	4.32	0.82	11700
LSES 90 L	1.5	1415	3.3	0.82	90%	100%	100%	100%	57%	2.61	2525	5.76	0.82	11700
LSES 90 LU	1.8	1435	3.8	0.81	90%	100%	100%	100%	57%	3.13	2545	6.86	0.81	11700
LSES 100 L	2.2	1420	4.8	0.83	90%	100%	100%	100%	57%	3.83	2530	8.3	0.83	9900
LSES 100 LR	3	1415	6.5	0.81	90%	100%	100%	100%	57%	5.22	2525	11.34	0.81	9900
LSES 112 MU	4	1420	8.5	0.84	90%	100%	100%	100%	57%	6.96	2530	14.81	0.84	9900
LSES 132 SU	5.5	1435	11.5	0.80	90%	90%	100%	100%	57%	9.57	2545	19.98	0.80	7600
LSES 132 M	7.5	1435	15.1	0.84	90%	90%	100%	100%	57%	13.05	2545	26.24	0.84	7600
LSES 132 M	9	1440	17.8	0.84	90%	90%	100%	100%	57%	15.66	2550	30.98	0.84	7600
LSES 160 MR	11	1445	21.9	0.84	85%	95%	100%	100%	57%	19.14	2555	38.09	0.84	7600
LSES 160 L	15	1452	29.9	0.84	85%	95%	100%	100%	57%	26.1	2562	51.97	0.84	6030
LSES 180 MT	18	1452	36.4	0.83	80%	90%	100%	100%	57%	32.19	2562	63.32	0.83	5670
LSES 180 LR	22	1454	42.4	0.84	80%	90%	100%	100%	57%	38.28	2564	73.81	0.84	5670
LSES 200 LR	28	1450	55.7	0.83	80%	89%	94%	94%	54%	48.96	2560	97.03	0.83	4500
LSES 225 ST	37	1460	73.5	0.82	85%	95%	100%	100%	57%	64.38	2570	127.99	0.82	4320
LSES 225 MR	45	1460	88.8	0.83	85%	95%	100%	100%	57%	78.3	2570	154.57	0.83	4320
LSES 250 ME	55	1480	108	0.83	85%	95%	100%	100%	57%	95.7	2590	187.92	0.83	4050
LSES 280 SD	75	1480	146	0.83	85%	95%	100%	100%	57%	130.5	2590	253.95	0.83	3420
LSES 280 MD	90	1480	176	0.81	85%	95%	100%	100%	57%	156.6	2590	306.43	0.81	3420
LSES 315 SP	110	1482	211	0.84	80%	90%	100%	100%	57%	191.4	2592	367.38	0.84	2700
LSES 315 MP	132	1482	250	0.85	80%	90%	100%	100%	57%	229.68	2592	435.09	0.85	2700
LSES 315 MP	160	1484	304	0.83	80%	90%	100%	100%	57%	278.4	2594	529.9	0.83	2700
LSES 315 MR	189	1482	356	0.83	76%	85%	95%	95%	54%	329.96	2592	619.6	0.83	2700
6 poles														
LSES 90 SL	0.75	930	2.05	0.68	100%	100%	100%	100%	57%	1.31	1670	3.56	0.68	11700
LSES 90 L	1.1	910	2.9	0.71	100%	100%	100%	100%	57%	1.91	1650	5.08	0.71	11700
LSES 100 L	1.5	915	4	0.69	100%	100%	100%	100%	57%	2.61	1655	6.94	0.69	9900
LSES 112 MG	2.2	940	5.5	0.73	100%	100%	100%	100%	57%	3.83	1680	9.65	0.73	9900
LSES 132 S	3	945	7.5	0.71	100%	100%	100%	100%	57%	5.22	1685	13.04	0.71	7600
LSES 132 M	4	945	9.2	0.77	100%	100%	100%	100%	57%	6.96	1685	16.08	0.77	6700
LSES 132 M	5.5	952	12.4	0.73	100%	100%	100%	100%	57%	9.57	1692	21.5	0.73	6700
LSES 160 M	7.5	966	16.7	0.74	100%	100%	100%	100%	57%	13.05	1706	29.12	0.74	6000
LSES 160 LUR	11	966	24	0.75	95%	100%	100%	100%	57%	19.14	1706	41.82	0.75	5670
LSES 180 L	15	966	31.2	0.81	80%	90%	100%	100%	57%	26.1	1706	54.34	0.81	5670
LSES 200 LR	18.5	962	39.2	0.80	80%	90%	100%	100%	57%	32.19	1702	68.23	0.80	4500
LSES 200 L	22	962	45.7	0.82	80%	90%	100%	100%	57%	38.28	1702	79.57	0.82	4500
LSES 225 MR	30	972	63	0.75	90%	100%	100%	100%	57%	52.2	1712	109.7	0.75	4320
LSES 250 ME	37	982	71	0.85	90%	100%	100%	100%	57%	64.38	1722	124.43	0.85	4050
LSES 280 SC	45	980	87	0.83	90%	100%	100%	100%	57%	78.3	1720	151.52	0.83	3420
LSES 280 MC	55	978	104	0.83	90%	100%	100%	100%	57%	95.7	1718	186.23	0.83	3420
LSES 315 SP	75	988	152	0.78	85%	90%	100%	100%	57%	130.5	1728	265.8	0.78	2700
LSES 315 MP	90	988	181	0.80	85%	90%	100%	100%	57%	156.6	1728	314.89	0.80	2700
LSES 315 MR	110	988	217	0.80	85%	90%	100%	100%	57%	191.4	1728	377.53	0.80	2700
LSES 315 MR	132	986	264	0.80	85%	90%	100%	100%	57%	229.68	1728	460.49	0.80	2700

(1) Data only valid for: 400 V 50 Hz Y motors and frame size ≤ 250 mm - 2 poles

(2) See Vibrations section on page 48

 Please refer to page 38 for variable speed applications
- Values given with a voltage drop of 30 V at the drive output

IMfinity® 3-phase induction motors - IE2 - IE3 - IE4 - Non IE Efficiency

IP55 aluminium frame

Electrical and mechanical characteristics

IE2 powered by the drive

Summary of recommended protection devices

Mains voltage	Cable length	Frame size	Winding protection	Insulated bearings
≤ 480 V	< 20 m	All frame sizes	Standard	No
	> 20 m and < 100 m	≤ 315	Standard	No
		≥ 315	RIS or drive filter	NDE
> 480 V and ≤ 690 V	< 20 m	< 250	Standard	No
		≥ 250	RIS or drive filter	NDE
	> 20 m and < 100 m	≤ 250	RIS or drive filter	NDE
		≥ 250	RIS or drive filter	NDE
		≥ 250	RIS or drive filter	NDE (or DE+NDE if no filter for ≥ 315)

RIS: Reinforced Insulation System.

The filter is recommended above frame size 315.

Standard insulation = 1500 V peak and 3500 V/μs.

Protection solutions exist (insulation for winding and bearings).

For different cable length(s) and/or voltage(s), please consult Leroy-Somer.



REMINDER: All 2, 4 and 6 pole motors placed on the EU market must be IE3 or IE2 and used with a variable speed drive:

- from 01/01/2015 for power ratings from 7.5 to 375 kW
- from 01/01/2017 for power ratings from 0.75 to 375 kW

Other drive mechanism solutions:



LSRPM / PLSRPM: permanent magnet synchronous motors 3 to 500 kW

Variable speed application, requiring IP55 or IP23 protection, high efficiency and/or compact dimensions.



CPLS: induction motors 95 to 2900 Nm

Application for variable speed operation requiring constant power over a broad speed range.



LSMV: induction motors 0.18 to 132 kW

Application for variable speed operation requiring constant torque over a wide speed range.



LSK: D.C. motors 2 to 750 kW



UNIMOTOR FM and HD: servomotors 0.7 to 136 Nm

IMfinity® 3-phase induction motors - IE2 - IE3 - IE4 - Non IE Efficiency

IP55 aluminium frame

Electrical and mechanical characteristics

IE3 powered by the mains

IP55 ALUMINIUM MOTORS

Type	Rated power P _n kW	Rated torque M _n N.m	Starting torque/ Rated torque M _d /M _n	Maximum torque/ Rated torque M _m /M _n	Starting current/ Rated current I _d /I _n	Moment of inertia J kg.m ²	Weight IM B3 kg	Noise LP db(A)	400V 50Hz							
									Rated speed N _n min ⁻¹	Rated current I _n A	Efficiency IEC 60034-2-1 2007 η			Power factor Cos φ		
											4/4	3/4	2/4	4/4	3/4	2/4
2 poles																
LSES 80 L	0.75	2.5	3.5	3.5	7.8	0.00095	9.9	58	2890	1.6	81.7	81.7	79.6	0.83	0.76	0.64
LSES 80 LG	1.1	3.7	2.6	3.2	6.8	0.00223	14.1	64	2885	2.25	83.7	84.7	84.0	0.85	0.79	0.67
LSES 90 SL	1.5	5	2.9	3.3	7.5	0.00223	15.6	64	2890	3	85.0	86.0	85.2	0.85	0.79	0.67
LSES 90 L	1.8	6	3.1	3.4	7.5	0.00292	17.8	67	2890	3.75	85.5	86.3	86.2	0.85	0.79	0.67
LSES 90 LU	2.2	7.3	3.1	3.4	8.0	0.00292	20.4	67	2895	4.25	86.3	87.5	87.2	0.86	0.80	0.69
LSES 100 L	3	10	3.5	3.5	8.4	0.00364	24.6	67	2885	5.8	87.3	88.5	88.2	0.86	0.81	0.70
LSES 100 LG	3.7	12.1	2.1	3.0	7.4	0.00941	35.2	71	2920	6.65	88.2	89.1	89.1	0.89	0.85	0.77
LSES 112 MG	4	13.1	2.0	2.9	7.0	0.00941	32.7	71	2920	7.3	88.6	89.7	89.8	0.89	0.85	0.77
LSES 132 S	5.5	18	2.3	3.1	7.4	0.01116	39.2	63	2925	10.3	89.6	90.7	90.7	0.87	0.83	0.74
LSES 132 SM	7.5	24.4	2.1	2.9	6.8	0.01102	55.7	67	2935	13.9	90.7	91.6	91.6	0.86	0.82	0.74
LSES 132 M	9	29.2	2.2	3.3	7.7	0.01203	59.3	67	2945	16.6	91.2	91.9	91.7	0.86	0.81	0.72
LSES 160 MP	11	35.7	1.9	2.9	6.9	0.0139	70	72	2940	20.2	91.6	92.3	92.1	0.86	0.82	0.73
LSES 160 M	15	48.6	2.3	2.8	7.8	0.049	95	69	2945	26.7	92.1	92.8	92.8	0.88	0.86	0.80
LSES 160 L	18.5	59.9	2.8	3.2	7.6	0.0551	100	68	2950	32.8	92.6	93.3	93.2	0.88	0.85	0.77
LSES 180 MR	22	71.2	3.2	3.2	8.7	0.0628	105	69	2950	38.8	92.9	93.6	93.6	0.88	0.85	0.77
LSES 200 LR	30	97.3	2.6	3.1	7.6	0.1106	170	73	2945	52.2	93.5	94.3	94.4	0.89	0.87	0.82
LSES 200 L	37	120	2.0	3.1	7.1	0.2492	201	73	2945	63.7	93.9	94.5	94.4	0.89	0.87	0.81
LSES 225 MR	45	146	2.7	3.4	8.1	0.1597	227	76	2950	77.5	94.3	94.8	94.8	0.89	0.86	0.79
LSES 250 MZ	55	178	2.5	3.5	8.2	0.1754	234	72	2945	94.5	94.6	95.2	95.2	0.89	0.86	0.80
LSES 280 SC	75	241	2.3	3.3	8.1	0.4092	350	79	2970	126	95.2	95.4	95.1	0.90	0.88	0.82
LSES 280 MC	90	289	2.5	3.6	8.5	0.476	382	80	2972	151	95.4	95.7	95.4	0.90	0.88	0.82
LSES 315 SN	110	354	2.6	3.1	8.0	0.5343	452	79	2968	185	95.5	95.9	95.8	0.90	0.88	0.84
LSES 315 MP	132	423	2.3	3.2	7.7	0.5784	660	80	2978	227	95.6	95.6	95.0	0.88	0.86	0.80
LSES 315 MP	160	513	2.2	3.3	7.7	1.2646	705	80	2978	274	95.8	95.9	94.3	0.88	0.86	0.80
LSES 315 MP	200	642	2.2	3.5	7.9	1.3841	768	80	2974	340	96.0	96.2	95.9	0.88	0.86	0.80
4 poles																
LSES 80 LG	0.75	4.95	2.2	2.9	6.2	0.00335	13.6	48	1450	1.65	83.2	83.9	82.6	0.80	0.72	0.59
LSES 80 L	0.9	5.9	2.6	3.1	6.4	0.00381	14.1	48	1450	1.9	83.5	84.2	83.0	0.80	0.72	0.59
LSES 90 SL	1.1	7.25	2.4	3.2	6.9	0.00418	16.2	45	1450	2.3	84.8	85.7	85.1	0.81	0.73	0.61
LSES 90 LU	1.5	9.85	2.9	3.7	7.7	0.00524	20.4	51	1452	3.2	85.6	86.2	84.9	0.79	0.70	0.57
LSES 100 L	1.8	11.8	2.4	2.7	6.6	0.00561	22.6	48	1452	3.7	86.0	86.5	85.4	0.82	0.74	0.62
LSES 100 LR	2.2	14.4	3.2	3.8	8.1	0.00676	25.8	47	1454	4.6	87.1	87.7	86.7	0.79	0.71	0.58
LSES 100 LG	3	19.6	2.5	3.3	7.2	0.01152	31	55	1460	6.05	88.3	89.1	88.6	0.81	0.74	0.61
LSES 112 MU	4	26.2	2.7	3.1	7.1	0.01429	37	53	1458	8.1	88.8	89.6	89.2	0.80	0.73	0.62
LSES 132 SM	5.5	35.9	2.8	3.6	8.6	0.02286	52	59	1462	10.3	90.3	91.1	90.8	0.85	0.79	0.68
LSES 132 MU	7.5	49.1	3.0	3.4	8.0	0.02965	62.6	61	1458	14	90.6	91.7	92.1	0.86	0.82	0.73
LSES 160 MR	9	58.7	3.1	3.7	8.9	0.03574	77.8	62	1464	16.7	91.2	92.0	91.8	0.85	0.79	0.68
LSES 160 M	11	71.7	2.3	3.1	7.3	0.0712	93	59	1466	20.5	91.6	92.6	92.8	0.85	0.81	0.72
LSES 160 LUR	15	97.6	2.6	3.5	8.4	0.0954	100	58	1468	27.7	92.3	93.1	93.2	0.85	0.81	0.71
LSES 180 M	18.5	120	3.0	2.9	7.8	0.2075	130	68	1468	33.7	92.9	93.7	93.7	0.85	0.81	0.72
LSES 180 LUR	22	143	3.3	3.2	8.2	0.1555	155	68	1470	40.9	93.2	93.7	93.6	0.83	0.78	0.69
LSES 200 LU	30	194	3.0	2.8	7.3	0.2704	225	63	1476	55.1	93.8	94.3	94.1	0.84	0.80	0.70
LSES 225 SR	37	239	3.3	3.2	8.0	0.2897	236	63	1480	69.8	94.2	94.5	94.1	0.81	0.76	0.65
LSES 225 MG	45	290	2.3	2.9	7.3	0.6573	318	70	1484	83	94.6	94.9	94.5	0.83	0.79	0.69
LSES 250 ME	55	354	2.3	2.7	7.3	0.7793	350	69	1484	101	94.9	95.3	95.2	0.83	0.79	0.70
LSES 280 SD	75	482	2.5	3.2	8.2	0.9595	428	69	1486	137	95.2	95.4	95.1	0.83	0.79	0.69
LSES 280 MD	90	579	2.6	3.5	8.5	1.0799	470	68	1484	166	95.5	95.7	95.4	0.82	0.77	0.66
LSES 315 SP	110	706	3.1	2.9	7.7	2.4322	690	76	1488	198	95.6	95.6	95.1	0.84	0.80	0.70
LSES 315 MP	132	848	3.1	2.8	7.3	3.223	740	76	1486	235	95.7	95.9	95.5	0.85	0.81	0.72
LSES 315 MP	160	1030	2.6	2.8	7.2	3.223	740	76	1486	291	95.9	96.0	95.5	0.83	0.78	0.67
LSES 315 MR	200	1290	3.0	2.9	7.4	3.2324	820	76	1486	361	96.1	96.3	95.9	0.83	0.78	0.68
6 poles																
LSES 90 SL	0.75	7.55	1.9	2.3	4.5	0.00378	16	56	950	1.9	79.1	80.1	78.3	0.72	0.63	0.50
LSES 90 LU	1.1	11	2.4	2.7	4.9	0.00519	21.5	56	956	2.75	81.9	82.3	80.3	0.71	0.61	0.48
LSES 100 LG	1.5	14.8	2.4	2.8	5.7	0.01523	30	43	966	3.6	83.5	84.1	82.6	0.72	0.64	0.50
LSES 112 MU	2.2	21.7	2.3	2.8	5.5	0.01899	37	46	966	5.4	84.5	85.0	83.7	0.70	0.61	0.49
LSES 132 SM	3	29.5	2.8	3.2	6.6	0.02528	48	50	972	6.85	86.5	87.0	85.9	0.73	0.65	0.53
LSES 132 M	4	39.3	2.7	2.9	6.5	0.03027	54	56	972	9	87.4	88.0	87.0	0.73	0.66	0.53
LSES 132 MU	5.5	54.4	2.6	2.9	6.4	0.03699	63.1	57	966	11.8	88.2	89.4	89.2	0.76	0.70	0.58
LSES 160 MU	7.5	73.2	2.0	3.1	6.0	0.1295	82	58	978	18.6	89.6	89.7	88.4	0.72	0.65	0.53
LSES 180 L	11	107	3.1	3.5	8.7	0.2048	130	62	982	22.6	91.2	91.4	90.4	0.77	0.69	0.57
LSES 180 LUR	15	146	3.1	3.2	8.5	0.253	150	63	980	30.6	91.5	91.9	91.3	0.77	0.70	0.58
LSES 200 L	18.5	180	2.2	2.9	7.1	0.33	200	61	980	36.3	92.1	92.8	92.6	0.80	0.75	0.66
LSES 200 LU	22	214	2.8	3.6	7.4	0.3901	236	62	980	44.6	92.5	93.0	92.5	0.77	0.71	0.61
LSES 225 MG	30	291	2.3	2.5	6.7	0.7222	284	64	986	54.9	93.4	93.8	93.4	0.84	0.80	0.70
LSES 250 ME	37	358	2.4	2.8	7.1	0.9234	310	64	986	66.6	93.9	94.4	94.3	0.85	0.81	0.72
LSES 280 SC	45	437	2.2	2.5	6.6	1.1279	377	64	984	81.2	94.0	94.6	94.5	0.85	0.82	0.74
LSES 280 MD	55	533	2.8	3.0	7.7	1.3995	444	59	986	98.7	94.7	95.2	95.0	0.85	0.81	0.72
LSES 315 SP	75	723	3.0	2.6	7.5	2.8937	630	71	990	147	94.9	95.0	94.2	0.78	0.73	0.61
LSES 315																

IMfinity® 3-phase induction motors - IE2 - IE3 - IE4 - Non IE Efficiency

IP55 aluminium frame

Electrical and mechanical characteristics

IE3 powered by the mains

Type	Rated power P _n kW	380V 50Hz				415V 50Hz				460V 60Hz			
		Rated speed	Rated current	Efficiency	Power factor	Rated speed	Rated current	Efficiency	Power factor	Rated speed	Rated current	Efficiency	Power factor
		N _n min ⁻¹	I _n A	η 4/4	Cos φ 4/4	N _n min ⁻¹	I _n A	η 4/4	Cos φ 4/4	N _n min ⁻¹	I _n A	η 4/4	Cos φ 4/4
2 poles													
LSES 80 L	0.75	2875	1.65	80.9	0.86	2900	1.55	81.6	0.81	3505	1.4	82.5	0.80
LSES 80 LG	1.1	2870	2.35	82.7	0.87	2895	2.2	84.2	0.83	3505	1.95	84.9	0.83
LSES 90 SL	1.5	2880	3.15	84.2	0.87	2900	2.9	85.7	0.83	3510	2.65	86.5	0.83
LSES 90 L	1.8	2880	3.95	85.0	0.87	2900	3.6	85.6	0.83	3510	3.3	86.9	0.83
LSES 90 LU	2.2	2875	4.4	85.9	0.88	2905	4.2	86.7	0.85	3505	3.75	87.6	0.85
LSES 100 L	3	2870	6	87.1	0.88	2900	5.65	87.8	0.84	3505	5.1	87.6	0.85
LSES 100 LG	3.7	2905	7	87.9	0.90	2925	6.4	88.5	0.88	3535	5.8	88.9	0.88
LSES 112 MG	4	2905	7.65	88.1	0.90	2925	7.1	89.0	0.88	3535	6.4	89.6	0.88
LSES 132 S	5.5	2910	10.6	89.2	0.88	2930	10	89.9	0.85	3540	8.9	90.7	0.86
LSES 132 SM	7.5	2925	14.5	90.1	0.87	2945	13.5	91.1	0.85	3545	12.1	91.6	0.85
LSES 132 M	9	2935	17.2	90.7	0.88	2950	16.3	91.4	0.84	3558	14.5	91.9	0.85
LSES 160 MP	11	2930	21	91.2	0.87	2945	19.7	91.9	0.84	3550	17.6	92.3	0.85
LSES 160 M	15	2935	27.9	91.9	0.89	2950	25.9	92.2	0.87	3550	23.3	92.5	0.87
LSES 160 L	18.5	2945	34	92.4	0.89	2954	32	92.9	0.87	3558	28.6	93.4	0.87
LSES 180 MR	22	2940	40.4	92.7	0.89	2958	38	93.1	0.87	3560	33.8	93.8	0.87
LSES 200 LR	30	2935	55	93.3	0.89	2954	50.4	93.8	0.88	3556	45.3	94.0	0.89
LSES 200 L	37	2930	66.6	93.7	0.90	2950	61.8	94.2	0.88	3552	55.6	94.5	0.89
LSES 225 MR	45	2940	81	94.0	0.90	2956	75.4	94.6	0.88	3560	67.2	94.9	0.89
LSES 250 MZ	55	2940	98.3	94.3	0.90	2954	92.3	94.8	0.88	3560	81.6	95.2	0.89
LSES 280 SC	75	2964	132	94.8	0.91	2974	123	95.4	0.89	3574	110	95.2	0.90
LSES 280 MC	90	2968	158	95.1	0.91	2972	148	95.5	0.89	3574	131	95.5	0.90
LSES 315 SN	110	2962	195	95.2	0.91	2970	179	95.6	0.89	3574	161	95.7	0.90
LSES 315 MP	132	2974	237	95.4	0.89	2984	220	95.7	0.87	3580	198	95.4	0.88
LSES 315 MP	160	2976	286	95.6	0.89	2980	267	95.9	0.87	3580	239	95.6	0.88
LSES 315 MP	200	2970	357	95.8	0.89	2980	335	96.1	0.86	3580	297	96.1	0.88
4 poles													
LSES 80 LG	0.75	1440	1.65	82.6	0.82	1452	1.6	83.29	0.78	1758	1.45	85.1	0.76
LSES 80 LG	0.9	1440	2	83.0	0.82	1452	1.8	83.60	0.78	1758	1.7	85.6	0.76
LSES 90 SL	1.1	1445	2.35	84.1	0.83	1454	2.3	85.42	0.79	1760	2.05	86.6	0.78
LSES 90 LU	1.5	1445	3.25	85.3	0.82	1456	3.2	85.75	0.77	1760	2.8	87.3	0.76
LSES 100 L	1.8	1445	3.9	85.4	0.83	1454	3.9	86.20	0.79	1760	3.3	87.0	0.78
LSES 100 LR	2.2	1445	4.7	86.7	0.82	1456	4.6	87.27	0.77	1760	4.15	88.4	0.76
LSES 100 LG	3	1452	6.2	87.7	0.84	1462	6.05	88.36	0.78	1766	5.35	90.0	0.79
LSES 112 MU	4	1450	8.3	88.6	0.83	1462	8.05	88.88	0.78	1764	7.1	90.2	0.79
LSES 132 SM	5.5	1456	10.7	89.6	0.87	1466	10.2	90.43	0.83	1768	9.05	91.7	0.83
LSES 132 MU	7.5	1450	14.5	90.4	0.87	1462	13.6	90.90	0.85	1766	12.1	92.0	0.84
LSES 160 MR	9	1458	17.4	90.9	0.86	1466	16.5	91.50	0.83	1768	14.7	92.4	0.83
LSES 160 M	11	1462	21.1	91.4	0.86	1470	19.8	91.91	0.84	1774	17.8	92.7	0.84
LSES 160 LUR	15	1464	28.7	92.1	0.86	1472	26.8	92.55	0.84	1774	24.2	93.3	0.83
LSES 180 M	18.5	1466	35.3	92.6	0.86	1474	33.1	93.16	0.84	1774	29.5	93.8	0.84
LSES 180 LUR	22	1466	42.4	93.0	0.85	1474	40.3	93.41	0.81	1770	36.4	93.8	0.81
LSES 200 LU	30	1472	56.8	93.6	0.85	1478	53.9	94.10	0.82	1778	48.1	94.5	0.83
LSES 225 SR	37	1476	71.7	93.9	0.83	1482	69.5	94.30	0.79	1782	61.2	94.5	0.80
LSES 225 MG	45	1480	86.2	94.3	0.85	1486	80.7	94.94	0.82	1786	72.3	95.0	0.82
LSES 250 ME	55	1482	105	94.6	0.84	1486	98.3	95.13	0.82	1786	87.9	95.4	0.82
LSES 280 SD	75	1484	142	95.0	0.85	1486	134	95.34	0.81	1786	120	95.6	0.82
LSES 280 MD	90	1482	170	95.3	0.84	1488	164	95.50	0.80	1788	148	95.7	0.80
LSES 315 SP	110	1486	206	95.4	0.85	1488	193	95.83	0.82	1790	176	95.8	0.82
LSES 315 MP	132	1484	243	95.6	0.86	1488	229	95.70	0.84	1790	210	96.2	0.82
LSES 315 MP	160	1484	300	95.8	0.85	1488	289	96.00	0.80	1790	254	96.2	0.82
LSES 315 MR	200	1484	371	96.0	0.85	1488	358	96.01	0.81	1790	316	96.4	0.82
6 poles													
LSES 90 SL	0.75	945	1.95	78.9	0.74	956	1.9	79.5	0.70	-	-	-	-
LSES 90 LU	1.1	950	2.75	81.3	0.75	960	2.75	82.1	0.68	-	-	-	-
LSES 100 LG	1.5	962	3.75	82.6	0.73	970	3.65	83.4	0.68	-	-	-	-
LSES 112 MU	2.2	960	5.4	84.3	0.73	970	5.4	84.5	0.67	-	-	-	-
LSES 132 SM	3	968	7	85.8	0.76	974	6.8	86.6	0.71	-	-	-	-
LSES 132 M	4	968	9.2	86.8	0.76	974	9.05	87.7	0.70	-	-	-	-
LSES 132 MU	5.5	960	12.1	88.0	0.78	968	11.7	88.5	0.74	-	-	-	-
LSES 160 MU	7.5	974	19.4	89.1	0.74	980	18.3	89.7	0.69	-	-	-	-
LSES 180 L	11	980	23.2	91.2	0.79	984	22.4	91.3	0.75	-	-	-	-
LSES 180 LUR	15	976	31.5	91.2	0.79	982	30.5	91.6	0.75	-	-	-	-
LSES 200 L	18.5	976	37.6	91.7	0.82	982	35.8	92.3	0.78	-	-	-	-
LSES 200 LU	22	978	43.8	92.2	0.79	984	42.2	92.7	0.74	-	-	-	-
LSES 225 MG	30	984	57.4	92.9	0.86	986	54.6	93.4	0.82	-	-	-	-
LSES 250 ME	37	984	69.2	93.6	0.86	988	66.1	94.0	0.83	-	-	-	-
LSES 280 SC	45	982	85.2	93.7	0.86	986	79.5	94.1	0.84	-	-	-	-
LSES 280 MD	55	984	102	94.3	0.86	988	96.1	94.8	0.84	-	-	-	-
LSES 315 SP	75	990	149	94.8	0.80	992	145	95.2	0.76	-	-	-	-
LSES 315 MP	90	990	177	95.0	0.82	992	169	95.1	0.78	-	-	-	-
LSES 315 MR	110	988	215	95.1	0.82	992	203	95.7	0.78	-	-	-	-
LSES 315 MR	132	990	260	95.4	0.81	990	245	95.5	0.78	-	-	-	-

IMfinity® 3-phase induction motors - IE2 - IE3 - IE4 - Non IE Efficiency

IP55 aluminium frame

Electrical and mechanical characteristics

IE3 powered by the drive

IP55 ALUMINIUM MOTORS

Type	400V 50Hz				% Rated torque M _n at					400V 87Hz Δ ¹				Maximum mechanical speed ²
	Rated power	Rated speed	Rated current	Power factor	10Hz	17Hz	25Hz	50Hz	87Hz	Rated power	Rated speed	Rated current	Power factor	
	P _n kW	N _n min ⁻¹	I _n A	Cos φ 4/4						P _n kW	N _n min ⁻¹	I _n A	Cos φ 4/4	
2 poles														
LSES 80 L	0.75	2850	1.65	0.83	90%	100%	100%	100%	57%	1.31	5070	2.88	0.83	13500
LSES 80 LG	1.1	2850	2.35	0.85	85%	100%	100%	100%	57%	1.91	5070	4.06	0.85	11700
LSES 90 SL	1.5	2845	3.15	0.85	85%	100%	100%	100%	57%	2.61	5065	5.5	0.85	11700
LSES 90 L	1.8	2870	3.75	0.85	85%	100%	100%	100%	57%	3.13	5090	6.5	0.85	11700
LSES 90 LU	2.2	2850	4.5	0.86	85%	100%	100%	100%	57%	3.83	5070	7.87	0.86	11700
LSES 100 L	3	2845	6.1	0.86	85%	100%	100%	100%	57%	5.22	5065	10.67	0.86	9900
LSES 100 LG	3.7	2890	7.3	0.89	85%	100%	100%	100%	57%	6.44	5090	12.7	0.89	9900
LSES 112 MG	4	2890	7.9	0.89	85%	100%	100%	100%	57%	6.96	5110	13.8	0.89	9900
LSES 132 S	5.5	2895	10.9	0.87	85%	100%	100%	100%	57%	9.57	5115	18.96	0.87	6700
LSES 132 SM	7.5	2910	14.7	0.86	85%	95%	100%	100%	57%	13.05	5130	25.56	0.86	6700
LSES 132 M	9	2925	17.5	0.86	85%	95%	100%	100%	57%	15.66	5145	30.47	0.86	6700
LSES 160 MP	11	2920	21.3	0.86	85%	95%	100%	100%	57%	19.14	5140	37.08	0.86	6700
LSES 160 M	15	2920	28.7	0.88	85%	95%	100%	100%	57%	26.1	5140	49.94	0.88	6000
LSES 160 L	18.5	2930	35	0.88	85%	95%	100%	100%	57%	32.19	5150	60.95	0.88	6000
LSES 180 MR	22	2930	41.65	0.88	85%	95%	100%	100%	57%	38.28	5150	72.46	0.88	5670
LSES 200 LR	30	2925	56	0.89	85%	90%	100%	100%	-	-	-	-	-	4500
LSES 200 L	37	2920	69.5	0.89	80%	90%	100%	100%	-	-	-	-	-	4500
LSES 225 MR	45	2930	83.3	0.89	80%	90%	100%	100%	-	-	-	-	-	4320
LSES 250 MZ	55	2925	93.85	0.89	73%	83%	92%	100%	-	-	-	-	-	4320
LSES 280 SC	75	2966	135	0.90	85%	90%	100%	100%	-	-	-	-	-	4050
LSES 280 MC	90	2960	162	0.90	85%	90%	100%	100%	-	-	-	-	-	4050
LSES 315 SN	110	2954	199	0.90	85%	90%	100%	100%	-	-	-	-	-	3600
LSES 315 MP	132	2972	239	0.88	80%	90%	100%	100%	-	-	-	-	-	3600
LSES 315 MP	160	2972	290	0.88	80%	90%	100%	100%	-	-	-	-	-	3600
LSES 315 MP	176	2968	320	0.88	71%	79%	88%	88%	-	-	-	-	-	3600
4 poles														
LSES 80 LG	0.75	1430	1.7	0.80	90%	100%	100%	100%	57%	1.31	2540	2.96	0.80	11700
LSES 80 LG	0.9	1440	2.45	0.80	90%	100%	100%	100%	57%	1.55	2550	3.47	0.80	11700
LSES 90 SL	1.1	1430	2.3	0.81	90%	100%	100%	100%	57%	1.91	2540	4.23	0.81	11700
LSES 90 LU	1.5	1440	3.3	0.79	90%	100%	100%	100%	57%	2.61	2550	5.76	0.79	11700
LSES 100 L	1.8	1440	3.9	0.82	90%	100%	100%	100%	57%	3.13	2550	6.77	0.82	9900
LSES 100 LR	2.2	1435	4.8	0.79	90%	100%	100%	100%	57%	3.83	2545	8.3	0.79	9900
LSES 100 LG	3	1445	6.4	0.81	90%	100%	100%	100%	57%	5.22	2555	11.09	0.81	9900
LSES 112 MU	4	1440	8.4	0.80	90%	100%	100%	100%	57%	6.96	2550	14.56	0.80	9900
LSES 132 SM	5.5	1450	11	0.85	90%	90%	100%	100%	57%	9.57	2560	19.13	0.85	6700
LSES 132 MU	7.5	1440	14.9	0.86	90%	90%	100%	100%	57%	13.05	2550	25.9	0.86	6700
LSES 160 MR	9	1452	17.8	0.85	90%	90%	100%	100%	57%	15.66	2562	30.98	0.85	6000
LSES 160 M	11	1454	21.6	0.85	85%	95%	100%	100%	57%	19.14	2564	37.58	0.85	6000
LSES 160 LUR	15	1456	29.2	0.85	85%	95%	100%	100%	57%	26.1	2566	50.79	0.85	5670
LSES 180 M	18.5	1460	36.3	0.85	80%	90%	100%	100%	57%	32.19	2570	63.15	0.85	5670
LSES 180 LUR	22	1458	43.6	0.83	80%	90%	100%	100%	57%	38.28	2568	75.85	0.83	4500
LSES 200 LU	30	1468	59.2	0.84	85%	95%	100%	100%	57%	52.2	2578	102.93	0.84	4500
LSES 225 SR	37	1474	73	0.81	85%	95%	100%	100%	57%	64.38	2584	126.97	0.81	4320
LSES 225 MG	45	1478	87.8	0.83	85%	95%	100%	100%	57%	78.3	2588	152.88	0.83	4050
LSES 250 ME	55	1480	108	0.83	85%	95%	100%	100%	57%	95.7	2590	187.92	0.83	4050
LSES 280 SD	75	1480	146	0.83	85%	95%	100%	100%	57%	130.5	2590	253.95	0.83	3420
LSES 280 MD	90	1480	176	0.82	85%	95%	100%	100%	57%	156.6	2590	306.43	0.82	3420
LSES 315 SP	110	1482	211	0.84	80%	90%	100%	100%	57%	191.4	2592	367.38	0.84	2700
LSES 315 MP	132	1482	250	0.85	80%	90%	100%	100%	57%	229.6	2592	435.09	0.85	2700
LSES 315 MP	160	1484	304	0.83	80%	90%	100%	100%	57%	278.4	2594	529.9	0.83	2700
LSES 315 MR	189	1482	356	0.83	80%	90%	90%	90%	57%	329.96	2592	619.6	0.83	2700
6 poles														
LSES 90 SL	0.75	930	1.95	0.7	100%	100%	100%	100%	57%	1.31	1670	3.39	0.72	11700
LSES 90 LU	1.1	940	2.75	0.7	100%	100%	100%	100%	57%	1.91	1680	4.74	0.71	11700
LSES 100 LG	1.5	954	3.8	0.7	100%	100%	100%	100%	57%	2.61	1694	6.6	0.72	9900
LSES 112 MU	2.2	954	5.5	0.7	100%	100%	100%	100%	57%	3.83	1694	9.57	0.70	9900
LSES 132 SM	3	962	6.9	0.7	100%	100%	100%	100%	57%	5.22	1702	12.02	0.73	6700
LSES 132 M	4	962	9.3	0.7	100%	100%	100%	100%	57%	6.96	1702	16.17	0.73	6700
LSES 132 MU	5.5	954	12.2	0.8	100%	100%	100%	100%	57%	9.57	1694	21.33	0.76	6700
LSES 160 MU	7.5	970	16.35	0.8	100%	100%	100%	100%	57%	13.05	1710	28.44	0.76	6700
LSES 180 L	11	976	23.45	0.8	95%	100%	100%	100%	57%	19.14	1716	40.8	0.77	5670
LSES 180 LUR	15	974	32	0.8	80%	90%	100%	100%	57%	26.1	1714	55.7	0.77	4500
LSES 200 L	18.5	972	38.2	0.8	80%	90%	100%	100%	57%	32.19	1712	66.53	0.80	4500
LSES 200 LU	22	974	46.3	0.8	80%	90%	100%	100%	57%	38.28	1714	80.59	0.77	4500
LSES 225 MG	30	980	58.6	0.8	90%	100%	100%	100%	57%	52.2	1720	101.92	0.84	4050
LSES 250 ME	37	982	71.5	0.9	90%	100%	100%	100%	57%	64.38	1722	124.43	0.85	4050
LSES 280 SC	45	980	87.1	0.9	90%	100%	100%	100%	57%	78.3	1720	151.52	0.85	3420
LSES 280 MD	55	984	104	0.9	90%	100%	100%	100%	57%	95.7	1724	181.15	0.85	3420
LSES 315 SP	75	988	152	0.8	85%	90%	100%	100%	57%	130.5	1728	265.8	0.78	2700
LSES 315 MP	90	988	181	0.8	85%	90%	100%	100%	57%	156.6	1728	314.89	0.80	2700
LSES 315 MR	110	988	217	0.8	85%	90%	100%	100%	57%	191.4	1728	377.53	0.80	2700
LSES 315 MR	132	986	265	0.8	85%	90%	100%	100%	57%	229.68	1726	460.49	0.80	2700

(1) Data only valid for: 400 V 50 Hz Y motors and frame size ≤ 250 mm - 2 poles

(2) See Vibrations section on page 48

 Please refer to page 38 for variable speed applications
- Values given with a voltage drop of 30 V at the drive output

IMfinity® 3-phase induction motors - IE2 - IE3 - IE4 - Non IE Efficiency

IP55 aluminium frame

Electrical and mechanical characteristics

IE3 powered by the drive

Summary of recommended protection devices

Mains voltage	Cable length	Frame size	Winding protection	Insulated bearings
≤ 480 V	< 20 m	All frame sizes	Standard	No
	> 20 m and < 100 m	≤ 315	Standard	No
		≥ 315	RIS or drive filter	NDE
> 480 V and ≤ 690 V	< 20 m	< 250	Standard	No
		≥ 250	RIS or drive filter	NDE
	> 20 m and < 100 m	≤ 250	RIS or drive filter	NDE
		≥ 250	RIS or drive filter	NDE
		≥ 250	RIS or drive filter	NDE (or DE+NDE if no filter for ≥ 315)

RIS: Reinforced Insulation System.

The filter is recommended above frame size 315.

Standard insulation = 1500 V peak and 3500 V/μs.

Protection solutions exist (insulation for winding and bearings).

For different cable length(s) and/or voltage(s), please consult Leroy-Somer.



REMINDER: All 2, 4 and 6 pole motors placed on the EU market must be IE3 or IE2 and used with a variable speed drive:

- from 01/01/2015 for power ratings from 7.5 to 375 kW
- from 01/01/2017 for power ratings from 0.75 to 375 kW

Other drive mechanism solutions:



LSRPM / PLSRPM: permanent magnet synchronous motors 3 to 500 kW

Variable speed application, requiring IP55 or IP23 protection, high efficiency and/or compact dimensions.



CPLS: induction motors 95 to 2900 Nm

Application for variable speed operation requiring constant power over a broad speed range.



LSMV: induction motors 0.18 to 132 kW

Application for variable speed operation requiring constant torque over a broad speed range.



LSK: D.C. motors 2 to 750 kW



UNIMOTOR FM and HD: servomotors 0.7 to 136 Nm

IMfinity® 3-phase induction motors - IE2 - IE3 - IE4 - Non IE Efficiency

IP55 aluminium frame

Electrical and mechanical characteristics

Mains connection

DESCRIPTIVE TABLE OF TERMINAL BOXES FOR 400 V RATED SUPPLY VOLTAGE (in accordance with EN 50262)

Series	Type	No. of poles	Terminal box material	Power + auxiliaries	
				Number of drill holes	Drill hole diameter
LS / LSES	56-63-71	2; 4; 6	Plastic	1 PE ISO 16	ISO M20 x 1,5
	80	2; 4; 6		1 + 1 knock-out	
	90	2; 4; 6			
	100	2; 4; 6			
	112	2; 4; 6			
	132*	2; 4; 6	Aluminium alloy	2	ISO M25 x 1,5
	160* L/LU/LUR/M/MU	2; 4; 6		3	2 ISO x M40 + 1 ISO x M16
	180 M/MR/MT/L/LR/LUR	2; 4; 6			
	200 L/LR/LU	2; 4; 6			2 ISO x M50 + 1 ISO x M16
	225 ST/SG/SR/MT/MR/MG	2; 4; 6			
	250 MZ	2		0	Removable undrilled mounting plate (see details page 164)
	250 ME	4; 6			
	280 SC/SD/MC/MD	2; 4; 6			
	315 SN	2			
315 SP/MP/MR	2; 4; 6				

*As an option, both ISO M25 cable glands may be replaced by 1 ISO x M25 and 1 ISO x M32 (to comply with standard DIN 42925).

TERMINAL BLOCKS DIRECTION OF ROTATION

Standard motors are fitted with a block of 6 terminals complying with standard NFC 51 120, with the terminal markings complying with IEC 60034-8 (or NF EN 60034-8).

When the motor is running in U1, V1, W1 or 1U, 1V, 1W from a direct mains supply L1, L2, L3, it turns clockwise when seen from the drive shaft end.

If any two of the phases are changed over, the motor will run in an anticlockwise direction (make sure that the motor has been designed to run in both directions). If the motor is fitted with accessories (thermal protection or space heater), these must be connected on screw dominos with labelled wires.

Tightening torque for the nuts on the terminal blocks.

Terminal	M4	M5	M6	M8	M10	M12	M16
Torque N.m	1	2,5	4	10	20	35	65

LS / LSES series	230/400V connections		400/690V connections
	No. of poles	Terminals	Terminals
56 to 71	2; 4; 6	M4	-
80 to 112	2; 4; 6	M5	M5
132 S/SU	2; 4; 6	M5	M5
132 SM/M/MU	2; 4; 6	M6	M6
160	2; 4; 6	M6	M6
180 M/MT/L	2; 4; 6	M6	M6
180 MR/LR	4; 6	M8	M6
180 LUR	4	M8	M6
	6	M6	M6
200 L/LU	2; 6	M8	M8
200 LR	2; 4; 6	M8	M6
225 ST/SG/SR	4	M10	M8
225 MT	2	M10	M8
225 MR	2; 4	M8	M8
225 MG	4	M10	M8
	6	M8	M8
250 ME	4	M10	M10
	6	M8	M8
250 MZ	2	M10	M8
280 SC	2	M12	M10
	6	M10	M8
280 MC	2	M12	M10
280 SD	4	M12	M10
280 MD	4	M12	M10
	6	M10	M10
315 SN	2	M16	M12
315 SP	4	M16	M12
	6	M12	M10
315 MP	6	M12	M10
	2; 4; 6	M16	M12
	2	M16	M16
315 MR	2	M16	M12
	2; 4	M16	M16
	6	M16	M12

IMfinity® 3-phase induction motors - IE2 - IE3 - IE4 - Non IE Efficiency

IP55 aluminium frame

Dimensions

Shaft extensions

Dimensions in millimetres

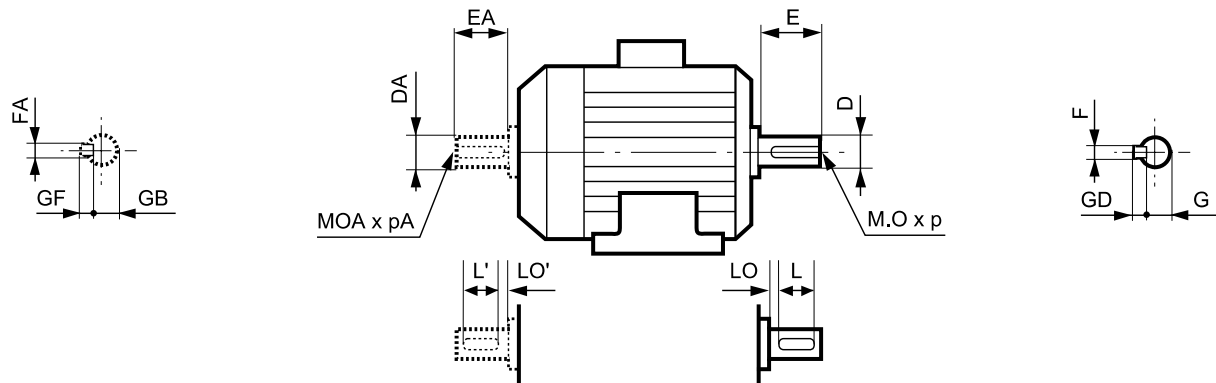

Type	Main shaft extensions																	
	4 and 6 poles									2 poles								
	F	GD	D	G	E	O	p	L	LO	F	GD	D	G	E	O	p	L	LO
LS 56 L	3	3	9j6	7	20	4	10	16	3	3	3	9j6	8	20	4	10	16	3
LS 63 M	4	4	11j6	8.5	23	4	10	18	3.5	4	4	11j6	8.5	23	4	10	18	3.5
LS 71 L	5	5	14j6	11	30	5	15	25	3.5	5	5	14j6	11	30	5	15	25	3.5
LSES 80 L/LU/LG ¹	6	6	19j6	15.5	40	6	16	30	6	6	6	19j6	15.5	40	6	16	30	6
LSES 90 SL/L/LU ¹	8	7	24j6	20	50	8	19	40	6	8	7	24j6	20	50	8	19	40	6
LSES 100 L/LR/LG ¹	8	7	28j6	24	60	10	22	50	6	8	7	28j6	24	60	10	22	50	6
LSES 112 MR/MG/MU ¹	8	7	28j6	24	60	10	22	50	6	8	7	28j6	24	60	10	22	50	6
LSES 112 M ¹	8	7	28j6	24	60	10	22	50	6	8	7	28j6	24	60	10	22	50	6
LSES 132 S/SU/SM/M/MU ¹	10	8	38k6	33	80	12	28	63	10	10	8	38k6	33	80	12	28	63	10
LSES 160 MP/MR/M/MU/L/LU/LUR ¹	12	8	42k6	37	110	16	36	100	6	12	8	42k6	37	110	16	36	100	6
LSES 180 M/MT/MR/L/LR/LUR ¹	14	9	48k6	42.5	110	16	36	98	12	14	9	48k6	42.5	110	16	36	98	12
LSES 200 L/LR/LU ¹	16	10	55m6	49	110	20	42	97	13	16	10	55m6	49	110	20	42	97	13
LSES 225 ST/MR/MT/MG ¹	18	11	60m6	53	140	20	42	126	14	16	10	55m6	49	110	20	42	97	13
LSES 225 SR ¹	18	11	60m6	53	140	20	42	125	15	16	10	55m6	49	110	20	42	97	13
LSES 250 ME/MZ/MF	18	11	65m6	58	140	20	42	126	14	18	11	60m6	53	140	20	42	126	14
LSES 280 SC/SD/SU/SK/MC/MD	20	12	75m6	67.5	140	20	42	125	15	18	11	65m6	58	140	20	42	125	14
LSES 315 SN/SP/MP/MR	22	14	80m6	71	170	20	42	155	15	18	11	65m6	58	140	20	42	126	14

1. The dimensions of frame sizes 80 to 225 motors concern the types LS and LSES

Type	Secondary shaft extensions																	
	4 and 6 poles								2 poles									
	FA	GF	DA	GB	EA	OA	pA	L'	LO'	FA	GF	DA	GB	EA	OA	pA	L'	LO'
LS 56 L	3	3	9j6	7	20	4	10	16	3	3	3	9j6	7	20	4	10	16	3
LS 63 M	4	4	11j6	8.5	23	4	10	18	3.5	4	4	11j6	8.5	23	4	10	18	3.5
LS 71 L	5	5	14j6	11	30	5	15	25	3.5	5	5	14j6	11	30	5	15	25	3.5
LSES 80 L/LU/LG ¹	5	5	14j6	11	30	5	15	25	3.5	5	5	14j6	11	30	5	15	25	3.5
LSES 90 SL/L/LU ¹	6	6	19j6	15.5	40	6	16	30	6	6	6	19j6	15.5	40	6	16	30	6
LSES 100 L/LR/LG ¹	8	7	24j6	20	50	8	19	40	6	8	7	24j6	20	50	8	19	40	6
LSES 112 MR/MG/MU ¹	8	7	24j6	20	50	8	19	40	6	8	7	24j6	20	50	8	19	40	6
LSES 112 M ¹	8	7	24j6	20	50	8	19	40	6	8	7	24j6	20	50	8	19	40	6
LSES 132 S/SU/SM/M/MU ¹	8	7	28k6	24	60	10	22	50	6	8	7	28k6	24	60	10	22	50	6
LSES 160 MU ¹	12	8	42k6	37	110	16	36	100	6	8	7	28k6	24	60	10	22	50	6
LSES 160 MP/MR ¹	10	8	38k6	33	80	12	28	63	10	10	8	38k6	33	80	12	28	63	10
LSES 160 ML/LU/LUR ¹	12	8	42k6	37	110	16	36	100	6	12	8	42k6	37	110	16	36	100	6
LSES 180 M/MT/MR/L/LR/LUR ¹	14	9	48k6	42.5	110	16	36	97	13	14	9	48k6	42.5	110	16	36	97	13
LSES 200 L/LR/LU ¹	16	10	55m6	49	110	20	42	97	13	16	10	55m6	49	110	20	42	97	13
LSES 225 ST/MR/MT/MG ¹	18	11	60m6	53	140	20	42	126	14	16	10	55m6	49	110	20	42	97	13
LSES 225 SR ¹	18	11	60m6	53	140	20	42	125	15	16	10	55m6	49	110	20	42	97	13
LSES 250 ME/MZ/MF	18	11	60m6	53	140	20	42	126	14	18	11	60m6	53	140	20	42	126	14
LSES 280 SC/SD/SU/SK/MC/MD	18	11	65m6	58	140	20	42	126	14	18	11	65m6	58	140	20	42	126	14
LSES 315 SN	20	12	75m6	67.5	140	20	42	125	15	18	11	65m6	58	140	20	42	125	14
LSES 315 SP/MP/MR	22	14	80m6	71	170	24	42	155	15	18	11	65m6	58	140	20	42	126	14

1. The dimensions of frame sizes 80 to 225 motors concern the types LS and LSES

IMfinity® 3-phase induction motors - IE2 - IE3 - IE4 - Non IE Efficiency

IP55 aluminium frame

Dimensions

Foot mounted IM 1001 (IM B3)

Dimensions in millimetres

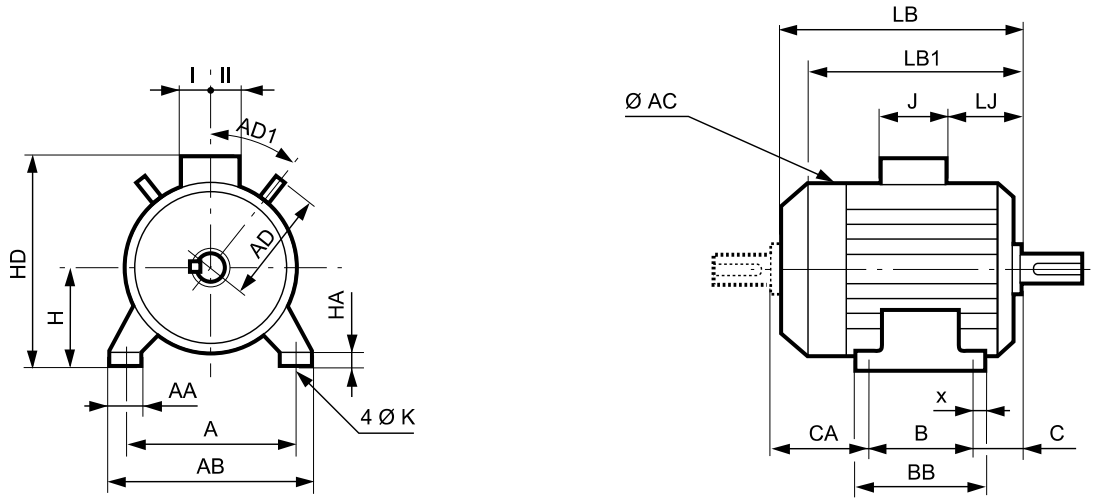

IP55 ALUMINIUM MOTORS

Type	Main dimensions																				
	A	AB	B	BB	C	x	AA	K	HA	H	AC*	HD	LB	LB1**	LJ	J	I	II	AD	AD1	CA
LS 56 L	90	104	71	87	36	8	24	6	7	56	110	140	156	134	16	86	43	43	-	-	51
LS 63 M	100	115	80	96	40	8	26	7	9	63	124	152	172	165	26	86	43	43	-	-	55
LS 71 L	112	126	90	106	45	8	24	7	9	71	140	170	193	166	21	86	43	43	-	-	61
LSES 80 L [†]	125	157	100	120	50	10	29	9	10	80	170	205	215	177	26	86	43	43	-	-	68
LSES 80 LU [†]	125	157	100	120	50	10	29	9	10	80	170	205	267	232	26	86	43	43	-	-	120
LSES 80 LG [†]	125	157	100	125	50	14	31	9	10	80	189	215	247	204	26	86	43	43	-	-	100
LSES 90 SL/L [†]	140	172	125	164	56	28	39	10	11	90	189	225	245	204	26	86	43	43	-	-	68
LSES 90 LU [†]	140	172	125	164	56	28	39	10	11	90	189	225	276	230	26	86	43	43	-	-	88
LSES 100 L [†]	160	196	140	165	63	12	40	12	13	100	200	240	290	250	27	86	43	43	118	45	95
LSES 100 LR [†]	160	196	140	165	63	12	40	12	13	100	200	240	309	264	27	86	43	43	118	45	111
LSES 100 LG [†]	160	196	140	168	63	13	40	12	14	100	227	249	315	265	36	86	43	43	130	45	118
LSES 112 M [†]	190	220	140	165	70	13	44	12	14	112	200	252	290	250	27	86	43	43	118	45	88
LSES 112 MR [†]	190	220	140	165	70	13	44	12	14	112	200	252	309	264	27	86	43	43	118	45	104
LSES 112 MU [†]	190	220	140	165	70	12	52	12	14	112	230	261	332	288	36	86	43	43	-	-	126
LSES 112 MG [†]	190	220	140	165	70	12	52	12	14	112	231	261	315	265	36	86	43	43	-	-	109
LSES 132 S [†]	216	250	140	170	89	15	42	12	16	132	227	304	351	306	32	126	63	63	130	45	128
LSES 132 SU [†]	216	250	140	170	89	15	42	12	16	132	227	304	383	329	32	126	63	63	130	45	152
LSES 132 SM [†]	216	250	140	208	89	15	50	12	15	132	272	322	385	330	17	126	63	63	140	45	164
LSES 132 M [†]	216	250	178	208	89	15	50	12	15	132	272	322	385	330	17	126	63	63	140	45	126
LSES 132 MU [†]	216	250	178	208	89	15	50	12	15	132	272	322	412	351	17	126	63	63	140	45	153
LSES 132 MR [†]	216	250	178	208	89	15	50	12	15	132	272	322	441	369	17	126	63	63	140	45	182
LSES 160 MP [†]	254	294	210	294	108	20	64	14	25	160	272	350	468	407	59	126	63	63	156	45	150
LSES 160 MR [†]	254	294	210	294	108	20	64	14	25	160	272	350	495	440	59	126	63	63	156	45	182
LSES 160 LR [†]	254	294	254	294	108	20	64	14	25	160	272	350	495	440	59	126	63	63	156	45	138
LSES 160 M [†]	254	294	210	294	108	20	60	14.5	25	160	312	395	495	435	44	134	92	63	186	45	182
LSES 160 MU/MUR [†]	254	294	210	294	108	20	60	14.5	25	160	312	395	510	435	44	134	92	63	186	45	197
LSES 160 L [†]	254	294	254	294	108	20	60	14.5	25	160	312	395	495	435	44	134	92	63	186	45	138
LSES 160 LU/LUR [†]	254	294	254	294	108	20	60	14.5	25	160	312	395	510	450	44	134	92	63	186	45	153
LSES 180 MT [†]	279	324	241	316	121	20	79	14.5	28	180	312	428	495	435	55	186	112	98	186	45	138
LSES 180 LT [†]	279	324	279	316	121	20	79	14.5	28	180	312	428	495	436	55	186	112	98	186	45	100
LSES 180 MR [†]	279	324	241	316	121	20	79	14.5	28	180	312	428	520	451	55	186	112	98	186	45	163
LSES 180 LR [†]	279	324	279	316	121	20	79	14.5	28	180	312	428	520	451	55	186	112	98	186	45	125
LSES 180 L [†]	279	339	279	329	121	25	86	14.5	25	180	350	436	552	484	64	186	112	98	-	-	159
LSES 180 LUR [†]	279	339	279	329	121	25	86	14.5	25	180	350	436	614	484	64	186	112	98	-	-	224
LSES 180 M [†]	279	339	241	291	121	25	86	14.5	25	180	350	436	552	484	64	186	112	98	-	-	197
LSES 180 MUR [†]	279	339	241	291	121	25	86	14.5	25	180	350	436	614	522	64	186	112	98	-	-	257
LSES 200 LR [†]	318	378	305	365	133	30	108	18.5	30	200	350	456	620	539	70	186	112	98	-	-	194
LSES 200 L [†]	318	388	305	375	133	35	103	18.5	36	200	390	476	621	539	77	186	112	98	-	-	194
LSES 200 LU [†]	318	388	305	375	133	35	103	18.5	36	200	390	476	669	587	77	186	112	98	-	-	244
LSES 225 ST [†]	356	431	286	386	149	50	127	18.5	36	225	390	535	627	545	61	231	119	141	-	-	203
LSES 225 SR [†]	356	431	286	386	149	50	127	18.5	36	225	390	535	676	545	61	292	119	141	-	-	253
LSES 225 MT [†]	356	431	311	386	149	50	127	18.5	36	225	390	535	627	545	61	231	119	141	-	-	178
LSES 225 MR [†]	356	431	311	386	149	50	127	18.5	36	225	390	535	676	593	61	292	119	141	-	-	228
LSES 225 MG [†]	356	420	311	375	149	30	65	18.5	33	225	479	630	810	728	68	292	151	181	283	45	360
LSES 250 MZ	406	470	349	449	168	70	150	24	47	250	390	560	676	593	61	231	119	141	-	-	171
LSES 250 ME	406	470	349	420	168	35	90	24	35	250	479	655	810	716	68	292	151	181	283	45	303
LSES 250 MF	406	470	349	420	168	35	90	24	35	250	479	625	870	776	68	292	151	181	283	45	363
LSES 280 MC	457	520	419	478	190	35	90	24	35	280	479	685	810	716	68	292	151	181	283	45	211
LSES 280 SC	457	520	368	478	190	35	90	24	35	280	479	685	810	716	68	292	151	181	283	45	262
LSES 280 SK	457	533	368	495	190	40	85	24	35	280	586	746	921	827	99	292	151	181	-	-	379
LSES 280 SU	457	533	368	495	190	40	85	24	35	280	586	746	991	897	99	292	151	181	-	-	449
LSES 280 SD	457	520	368	478	190	35	90	24	35	280	479	685	870	870	68	292	151	181	283	45	322
LSES 280 MD	457	520	419	478	190	35	90	24	35	280	479	685	870	870	68	292	151	181	283	45	271
LSES 315 SN	508	594	406	537	216	40	140	28	50	315	479	720	870	776	68	420	151	181	283	45	258
LSES 315 SP	508	594	406	537	216	40	114	28	70	315	586	870	947	845	61	420	180	235	-	-	341
LSES 315 MP	508	594	457	537	216	40	114	28	70	315	586	870	947	845	61	420	180	235	-	-	290
LSES 315 MR	508	594	457	537	216	40	114	28	70	315	586	870	1017	947	61	420	180	235	-	-	360

* AC: housing diameter without lifting rings

** LB1: non-ventilated motor

1. The dimensions of frame sizes 80 to 225 motors concern the types LS and LSES

IMfinity® 3-phase induction motors - IE2 - IE3 - IE4 - Non IE Efficiency

IP55 aluminium frame

Dimensions

Foot and flange mounted IM 2001 (IM B35)

Dimensions in millimetres

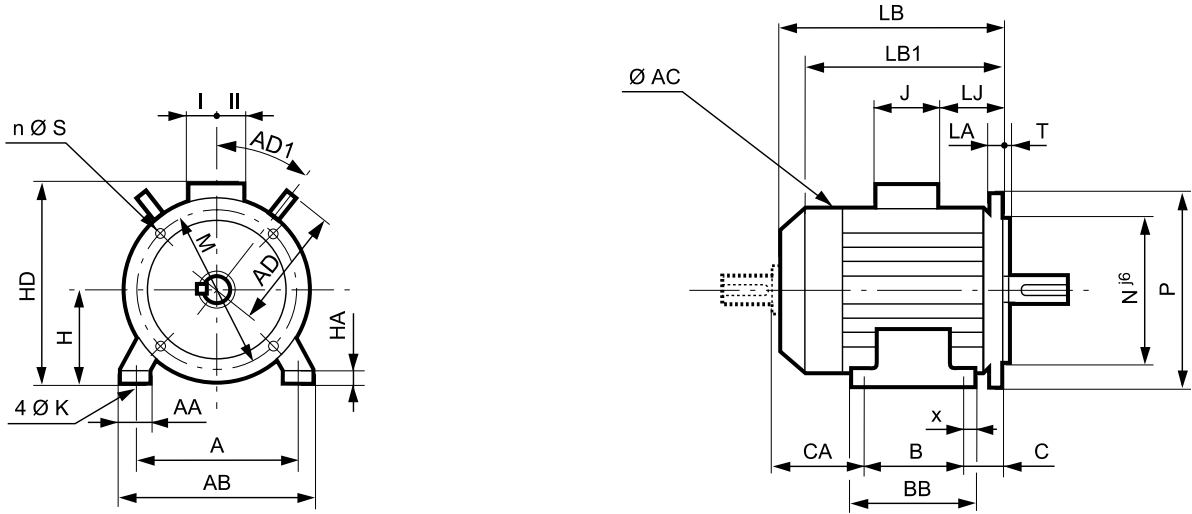

Type	Main dimensions																					
	A	AB	B	BB	C	x	AA	K	HA	H	AC*	HD	LB	LB1**	LJ	J	I	II	AD	AD1	CA	Symb
LS 56 L	90	104	71	87	36	8	25	6	7	56	110	140	156	134	16	86	43	43	-	-	51	FF 100
LS 63 M	100	115	80	96	40	8	26	7	9	63	124	152	172	165	26	86	43	43	-	-	55	FF 115
LS 71 L	112	125	90	106	45	8	24	7	9	71	140	170	193	166	26	86	43	43	-	-	61	FF 130
LSES 80 L ¹	125	157	100	120	50	10	29	9	10	80	170	205	215	177	26	86	43	43	-	-	68	FF 165
LSES 80 LU ¹	125	157	100	120	50	10	29	9	10	80	170	205	267	232	26	86	43	43	-	-	120	FF 165
LSES 80 LG ¹	125	157	100	125	70 ²	14	31	9	10	80	189	215	267	224	26	86	43	43	-	-	100	FF 165
LSES 90 SL/L ¹	140	172	125	164	56	28	39	10	11	90	189	225	265	224	26	86	43	43	-	-	68	FF 165
LSES 90 LU ¹	140	172	125	164	56	28	39	10	11	90	189	225	296	250	26	86	43	43	-	-	88	FF 165
LSES 100 L ¹	160	196	140	165	63	12	40	12	13	100	200	240	290	250	27	86	43	43	118	45	95	FF 215
LSES 100 LR ¹	160	196	140	165	63	12	40	12	13	100	200	240	309	264	27	86	43	43	118	45	111	FF 215
LSES 100 LG ¹	160	196	140	168	63	13	40	12	14	100	227	249	315	265	36	86	43	43	130	45	118	FF 215
LSES 112 M ¹	190	220	140	165	70	13	44	12	14	112	200	252	290	250	27	86	43	43	118	45	88	FF 215
LSES 112 MR ¹	190	220	140	165	70	13	44	12	14	112	200	252	309	264	27	86	43	43	118	45	104	FF 215
LSES 112 MU ¹	190	220	140	165	70	12	52	12	14	112	230	261	332	288	36	86	43	43	-	-	126	FF 215
LSES 112 MG ¹	190	220	140	165	70	12	52	12	14	112	231	261	315	265	36	86	43	43	-	-	109	FF 215
LSES 132 S ¹	216	250	140	170	89	15	42	12	16	132	227	304	351	306	32	126	63	63	130	45	128	FF 265
LSES 132 SU ¹	216	250	140	170	89	15	42	12	16	132	227	304	383	329	32	126	63	63	130	45	152	FF 265
LSES 132 SM ¹	216	250	140	208	89	15	50	12	15	132	272	322	385	330	17	126	63	63	140	45	164	FF 265
LSES 132 M ¹	216	250	178	208	89	15	50	12	15	132	272	322	385	330	17	126	63	63	140	45	126	FF 265
LSES 132 MU ¹	216	250	178	208	89	15	50	12	15	132	272	322	412	351	17	126	63	63	140	45	153	FF 265
LSES 132 MR ¹	216	250	178	208	89	15	50	12	15	132	272	322	441	369	17	126	63	63	140	45	182	FF 265
LSES 160 MP ¹	254	294	210	294	108	20	64	14	25	160	272	350	468	407	59	126	63	63	156	45	150	FF 300
LSES 160 MR ¹	254	294	210	294	108	20	64	14	25	160	272	350	495	440	59	126	63	63	156	45	182	FF 300
LSES 160 LR ¹	254	294	254	294	108	20	64	14	25	160	272	350	495	440	59	126	63	63	156	45	138	FF 300
LSES 160 M ¹	254	294	210	294	108	20	60	14.5	25	160	312	395	495	435	44	134	92	63	186	45	182	FF 300
LSES 160 MU/MUR ¹	254	294	210	294	108	20	60	14.5	25	160	312	395	510	435	44	134	92	63	186	45	197	FF 300
LSES 160 L ¹	254	294	254	294	108	20	60	14.5	25	160	312	395	495	435	44	134	92	63	186	45	138	FF 300
LSES 160 LU/LUR ¹	254	294	254	294	108	20	60	14.5	25	160	312	395	510	450	44	134	92	63	186	45	153	FF 300
LSES 180 MT ¹	279	324	241	316	121	20	79	14.5	28	180	312	428	495	435	55	186	112	98	186	45	138	FF 300
LSES 180 LT ¹	279	324	279	316	121	20	79	14.5	28	180	312	428	495	436	55	186	112	98	186	45	100	FF 300
LSES 180 MR ¹	279	324	241	316	121	20	79	14.5	28	180	312	428	520	451	55	186	112	98	186	45	163	FF 300
LSES 180 LR ¹	279	324	279	316	121	20	79	14.5	28	180	312	428	520	451	55	186	112	98	186	45	125	FF 300
LSES 180 L ¹	279	339	279	329	121	25	86	14.5	25	180	350	436	552	484	64	186	112	98	-	-	159	FF 300
LSES 180 LUR ¹	279	339	279	329	121	25	86	14.5	25	180	350	436	614	484	64	186	112	98	-	-	224	FF 300
LSES 180 M ¹	279	339	241	291	121	25	86	14.5	25	180	350	436	552	525	64	186	112	98	-	-	197	FF 300
LSES 180 MUR ¹	279	339	241	291	121	25	86	14.5	25	180	350	436	614	522	64	186	112	98	-	-	257	FF 300
LSES 200 LR ¹	318	378	305	365	133	30	108	18.5	30	200	350	456	620	539	70	186	112	98	-	-	194	FF 350
LSES 200 L ¹	318	388	305	375	133	35	103	18.5	36	200	390	476	621	539	77	186	112	98	-	-	194	FF 350
LSES 200 LU ¹	318	388	305	375	133	35	103	18.5	36	200	390	476	669	587	77	186	112	98	-	-	244	FF 350
LSES 225 ST ¹	356	431	286	386	149	50	127	18.5	36	225	390	535	627	545	61	231	119	141	-	-	203	FF 400
LSES 225 SR ¹	356	431	286	386	149	50	127	18.5	36	225	390	535	676	545	61	292	119	141	-	-	253	FF 400
LSES 225 MT ¹	356	431	311	386	149	50	127	18.5	36	225	390	535	627	545	61	231	119	141	-	-	178	FF 400
LSES 225 MR ¹	356	431	311	386	149	50	127	18.5	36	225	390	535	676	593	61	292	119	141	-	-	228	FF 400
LSES 225 MG ¹	356	420	311	375	149	30	65	18.5	33	225	479	630	810	728	68	292	151	181	283	45	360	FF 400
LSES 250 MZ	406	470	349	449	168	70	150	24	47	250	390	560	676	593	61	231	119	141	-	-	171	FF 500
LSES 250 ME	406	470	349	420	168	35	90	24	35	250	479	655	810	716	68	292	151	181	283	45	303	FF 500
LSES 250 MF	406	470	349	420	168	35	90	24	35	250	479	625	870	776	68	292	151	181	283	45	363	FF 500
LSES 280 MC	457	520	419	478	190	35	90	24	35	280	479	685	810	716	68	292	151	181	283	45	211	FF 500
LSES 280 SC	457	520	368	478	190	35	90	24	35	280	479	685	810	716	68	292	151	181	283	45	262	FF 500
LSES 280 SK	457	533	368	495	190	40	85	24	35	280	586	746	921	827	99	292	151	181	-	-	379	FF 500
LSES 280 SU	457	533	368	495	190	40	85	24	35	280	586	746	991	897	99	292	151	181	-	-	449	FF 500
LSES 280 SD	457	520	368	478	190	35	90	24	35	280	479	685	870	870	68	292	151	181	283	45	322	FF 500
LSES 280 MD	457	520	419	478	190	35	90	24	35	280	479	685	870	870	68	292	151	181	283	45	271	FF 500
LSES 315 SN	508	594	406	537	216	40	140	28	50	315	479	720	870	776	68	420	151	181	283	45	258	FF 600
LSES 315 SP	508	594	406	537	216	40	114	28	70	315	586	870	947	845	61	420	180	235	-	-	341	FF 600
LSES 315 MP	508	594	457	537	216	40	114	28	70	315	586	870	947	845	61	420	180	235	-	-	290	FF 600
LSES 315 MR	508	594	457	537	216	40	114	28	70	315	586	870	1017	947	61	420	180	235	-	-	360	FF 600

* AC: housing diameter without lifting rings

** LB1: non-ventilated motor

1. The dimensions of frame sizes 80 to 225 motors concern the types LS and LSES

2. Out of IEC

IMfinity® 3-phase induction motors - IE2 - IE3 - IE4 - Non IE Efficiency

IP55 aluminium frame

Dimensions

Foot and face mounted IM 2101 (IM B34)

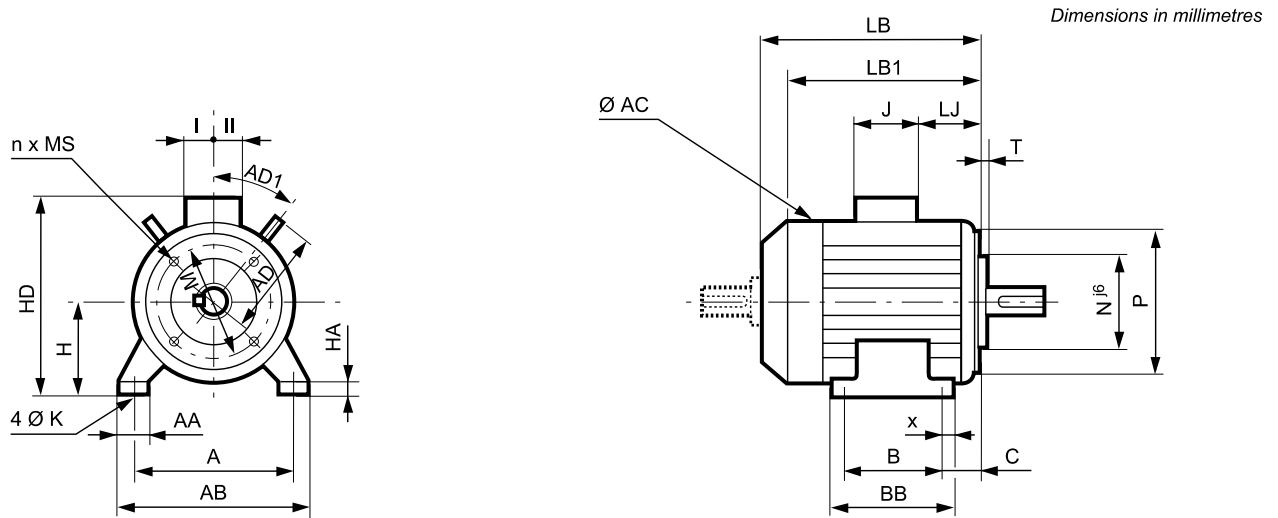

Dimensions in millimetres

Type	Main dimensions																				Symbol	
	A	AB	B	BB	C	x	AA	K	HA	H	AC*	HD	LB	LB1**	LJ	J	I	II	AD	AD1		CA
LS 56 L	90	104	71	87	36	8	25	6	7	56	110	140	156	134	16	86	43	43	-	-	51	FT 65
LS 63 M	100	115	80	96	40	8	26	7	9	63	124	152	172	165	26	86	43	43	-	-	55	FT 75
LS 71 L	112	126	90	106	45	8	24	7	9	71	140	170	193	166	26	86	43	43	-	-	61	FT 85
LSES 80 L ¹	125	157	100	120	50	10	29	9	10	80	170	205	215	177	26	86	43	43	-	-	68	FT 100
LSES 80 LU ¹	125	157	100	120	50	10	29	9	10	80	170	205	267	232	26	86	43	43	-	-	120	FT 100
LSES 80 LG ¹	125	157	100	125	50	14	31	9	10	80	189	215	247	204	26	86	43	43	-	-	100	FT 100
LSES 90 SL/L ¹	140	172	125	164	56	28	39	10	11	90	189	225	245	204	26	86	43	43	-	-	68	FT 115
LSES 90 LU ¹	140	172	125	164	56	28	39	10	11	90	189	225	276	230	26	86	43	43	-	-	88	FT 115
LSES 100 L ¹	160	196	140	165	63	12	40	12	13	100	200	240	290	250	27	86	43	43	118	45	95	FT 130
LSES 100 LR ¹	160	196	140	165	63	12	40	12	13	100	200	240	309	264	27	86	43	43	118	45	111	FT 130
LSES 100 LG ¹	160	196	140	168	63	13	40	12	14	100	227	249	315	265	36	86	43	43	130	45	118	FT 130
LSES 112 M ¹	190	220	140	165	70	13	44	12	14	112	200	252	290	250	27	86	43	43	118	45	88	FT 130
LSES 112 MR ¹	190	220	140	165	70	13	44	12	14	112	200	252	309	264	27	86	43	43	118	45	104	FT 130
LSES 112 MU ¹	190	220	140	165	70	12	52	12	14	112	230	261	332	288	36	86	43	43	-	-	126	FT 130
LSES 112 MG ¹	190	220	140	165	70	12	52	12	14	112	231	261	315	265	36	86	43	43	-	-	109	FT 130
LSES 132 S ¹	216	250	140	170	89	15	42	12	16	132	227	304	351	306	32	126	63	63	130	45	128	FT 165
LSES 132 SU ¹	216	250	140	170	89	15	42	12	16	132	227	304	383	329	32	126	63	63	130	45	152	FT 165
LSES 132 SM ¹	216	250	140	208	89	15	50	12	15	132	272	322	385	330	17	126	63	63	140	45	164	FT 165
LSES 132 M ¹	216	250	178	208	89	15	50	12	15	132	272	322	385	330	17	126	63	63	140	45	126	FT 165
LSES 132 MU ¹	216	250	178	208	89	15	50	12	15	132	272	322	412	351	17	126	63	63	140	45	153	FT 165
LSES 132 MR ¹	216	250	178	208	89	15	50	12	15	132	272	322	441	369	17	126	63	63	140	45	182	FT 165
LSES 160 MP ¹	254	294	210	294	108	20	64	14	25	160	272	350	468	407	59	126	63	63	156	45	150	FT 215
LSES 160 MR ¹	254	294	210	294	108	20	64	14	25	160	272	350	495	440	59	126	63	63	156	45	182	FT 215
LSES 160 LR ¹	254	294	254	294	108	20	64	14	25	160	272	350	495	440	59	126	63	63	156	45	138	FT 215

* AC: housing diameter without lifting rings

** LB1: non-ventilated motor

1. The dimensions of frame sizes 80 to 225 motors concern the types LS and LSES

IMfinity® 3-phase induction motors - IE2 - IE3 - IE4 - Non IE Efficiency

IP55 aluminium frame

Dimensions

Face mounted IM 3601 (IM B14)

Dimensions in millimetres

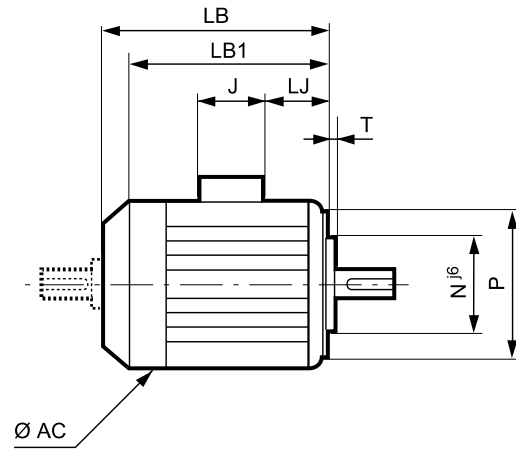
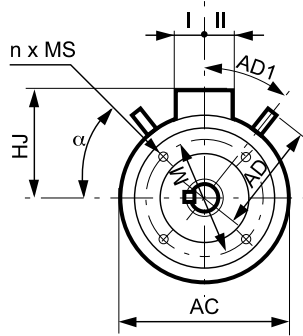

Type	Main dimensions									
	AC*	LB	LB1**	HJ	LJ	J	I	II	AD	AD1
LS 56 L	110	156	134	84	16	86	43	43	-	-
LS 63 M	134	172	165	89	26	86	43	43	-	-
LS 71 L	140	193	166	99	21	86	43	43	-	-
LSES 80 L ¹	170	215	177	125	26	86	43	43	-	-
LSES 80 LU ¹	170	267	232	125	26	86	43	43	-	-
LSES 80 LG ¹	189	245	204	135	26	86	43	43	-	-
LSES 90 SL/L ¹	189	245	204	135	26	86	43	43	-	-
LSES 90 LU ¹	189	276	230	135	26	86	43	43	-	-
LSES 100 L ¹	200	290	250	140	27	86	43	43	118	45
LSES 100 LR ¹	200	309	264	140	27	86	43	43	118	45
LSES 100 LG ¹	227	315	265	149	36	86	43	43	130	45
LSES 112 M ¹	200	290	250	140	27	86	43	43	118	45
LSES 112 MR ¹	200	309	264	140	27	86	43	43	118	45
LSES 112 MU ¹	230	332	288	149	36	86	43	43	-	-
LSES 112 MG ¹	231	315	265	149	36	86	43	43	-	-
LSES 132 S ¹	227	351	306	172	32	126	63	63	130	45
LSES 132 SU ¹	227	383	329	172	32	126	63	63	130	45
LSES 132 SM ¹	272	385	330	190	17	126	63	63	140	45
LSES 132 M ¹	272	385	330	190	17	126	63	63	140	45
LSES 132 MU ¹	272	412	351	190	17	126	63	63	140	45
LSES 132 MR ¹	272	441	369	190	17	126	63	63	140	45
LSES 160 MP ¹	272	468	407	190	59	126	63	63	156	45
LSES 160 MR ¹	272	495	440	190	59	126	63	63	156	45
LSES 160 LR ¹	272	495	440	190	59	126	63	63	156	45

Symbol IEC	Faceplate dimensions						
	M	N	P	T	n	α°	MS
FT 65	65	50	80	2.5	4	45	M5
FT 75	75	60	90	2.5	4	45	M5
FT 85	85	70	105	2.5	4	45	M6
FT 100	100	80	120	3	4	45	M6
FT 100	100	80	120	3	4	45	M6
FT 100	100	80	120	3	4	45	M6
FT 115	115	95	140	3	4	45	M8
FT 115	115	95	140	3	4	45	M8
FT 130	130	110	160	3.5	4	45	M8
FT 130	130	110	160	3.5	4	45	M8
FT 130	130	110	160	3.5	4	45	M8
FT 130	130	110	160	3.5	4	45	M8
FT 130	130	110	160	3.5	4	45	M8
FT 130	130	110	160	3.5	4	45	M8
FT 165	165	130	200	3.5	4	45	M10
FT 165	165	130	200	3.5	4	45	M10
FT 165	165	130	200	3.5	4	45	M10
FT 165	165	130	200	3.5	4	45	M10
FT 165	165	130	200	3.5	4	45	M10
FT 215	215	180	250	4	4	45	M12
FT 215	215	180	250	4	4	45	M12
FT 215	215	180	250	4	4	45	M12

* AC: housing diameter without lifting rings

** LB1: non-ventilated motor

1. The dimensions of frame sizes 80 to 225 motors concern the types LS and LSES

IMfinity® 3-phase induction motors - IE2 - IE3 - IE4 - Non IE Efficiency

IP55 aluminium frame

Construction

Bearings and lubrication

PERMANENTLY GREASED BEARINGS

Under normal operating conditions, the service life in hours of the bearing is indicated in the table below for ambient temperatures less than 55°C.

Series	Type	No. of poles	Types of permanently greased bearing		Bearing life according to speed of rotation									
					3000 min ⁻¹			1500 min ⁻¹			1000 min ⁻¹			
					25°C	40°C	55°C	25°C	40°C	55°C	25°C	40°C	55°C	
LS	56	2; 4; 6	6201 C3	6201 C3	≥40000	≥40000	≥40000	≥40000	≥40000	≥40000	≥40000	≥40000	38500	
	63	2; 4; 6	6201 C3	6202 C3	≥40000	≥40001	≥40002	≥40003	≥40004	≥40005	≥40006	≥40007	≥40008	
	71													
LS / LSES	80 L	2	6203 CN	6204 C3	≥40000	≥40000	25000	-	-	-	-	-	-	
	80 LG	2; 4	6204 C3	6205 C3	≥40000	≥40000	24000	≥40000	≥40000	31000	-	-	-	
	90 SL/L	2; 4; 6									≥40000	≥40000	34000	
	90 LU	4	6205 C3	6205 C3	-	-	-	≥40000	≥40000	30000	-	-	-	
	100 L	2; 4; 6	6205 C3	6206 C3	≥40000	≥40000	22000	≥40000	≥40000	30000	≥40000	≥40000	33000	
	100 LR	4			-	-	-	-	-	-				
	112 M	2	6205 C3	6206 C3	≥40000	≥40000	22000	-	-	-	-	-	-	
	112 MG	2; 6			-	-	-	≥40000	≥40000	33000				
	112 MU	4	6206 C3	6206 C3	-	-	-	≥40000	≥40000	30000	-	-	-	
	132 S	2; 6	6206 C3	6208 C3	≥40000	≥40000	19000	-	-	-	≥40000	≥40000	30000	
	132 SU	2; 4			-	-	-	≥40000	≥40000	25000	-	-	-	
	132 SM/M	2; 4; 6	6207 C3	6308 C3	≥40000	≥40000	19000	≥40000	≥40000	25000	≥40000	≥40000	30000	
	132 MU	4; 6	6307 C3	6308 C3	-	-	-	≥40000	≥40000	25000	≥40000	≥40000	30000	
	160 MR	2; 4	6308 C3	6309 C3	≥40000	35000	15000	≥40000	≥40000	24000	-	-	-	
	160 MP	2; 4	6208 C3	6309 C3	≥40000	35000	18000	≥40000	≥40000	24000	-	-	-	
	160 M/MU	6	6210 C3	6309 C3	-	-	-	-	-	-	-	≥40000	≥40000	27000
	160 L	2; 4; 6			≥40000	30000	15000	≥40000	≥40000	23000	-	-	-	
	160 LUR	4; 6	6210 C3	6310 C3	-	-	-	≥40000	≥40000	23000	≥40000	≥40000	27000	
	180 MT	2; 4			≥40000	30000	15000	-	-	-	-	-	-	
	180 M	4	6212 C3	6310 C3	-	-	-	≥40000	≥40000	24900	-	-	-	
	180 L	6			-	-	-	-	-	-	≥40000	≥40000	28000	
	180 LR	4	6210 C3	6310 C3	-	-	-	≥40000	≥40000	23000	-	-	-	
	180 LUR	4; 6	6312 C3	6310 C3	-	-	-	≥40000	≥40000	22000	≥40000	≥40000	27000	
	200 L	2; 6	6214 C3	6312 C3	≥40000	25000	12500	-	-	-	≥40000	≥40000	27000	
	200 LR	2; 4; 6	6312 C3	6312 C3	≥40000	25000	12500	≥40000	≥40000	22000	≥40000	≥40000	27000	
	200 LU	4; 6			-	-	-	-	-	-	-	-	-	
	225 ST	4	6205 C3	6313 C3	-	-	-	≥40000	≥40000	21000	-	-	-	
	225 MT	2			≥40000	22000	11000	-	-	-	-	-	-	
	225 SR	4	6312 C3	6313 C3	-	-	-	≥40000	≥40000	21000	-	-	-	
	225 MR	2; 4; 6			≥40000	22000	11000	-	-	-	≥40000	≥40000	26000	
225 SG	4	6216 C3	6314 C3	-	-	-	≥40000	≥40000	20000	-	-	-		
225 MG	4; 6			-	-	-	-	-	-	≥40000	≥40000	25000		

Note: On request, all motors can be fitted with grease nipples, except the 132 S/SU.

IMfinity® 3-phase induction motors - IE2 - IE3 - IE4 - Non IE Efficiency

IP55 aluminium frame

Construction

Bearings and lubrication

BEARINGS WITH GREASE NIPPLES

The chart opposite shows the greasing intervals, depending on the type of motor, for standard bearing assemblies of frame size ≥ 160 mm fitted with grease nipples, operating at an ambient temperature of 25°C, 40°C and 55°C on a horizontal shaft machine

SPECIAL CONSTRUCTION AND ENVIRONMENT

For vertical shaft machines, the greasing intervals will be approximately 80% of the values stated in the table below.

Note: The quality and quantity of grease and the greasing interval are shown on the machine nameplate.

For special assemblies (motors fitted with DE roller bearings or other types), machines of frame size ≥ 160 mm have bearings with grease nipples.

Instructions for bearing maintenance are given on the nameplates on these machines.

The chart below is valid for motors lubricated with Polyrex EM103 grease, which is used as standard

Series	Type	No. of poles	Type of bearings for greaser bearing bush		Quantity of grease g	Greasing intervals in hours								
			N.D.E.	D.E.		3000 min ⁻¹			1500 min ⁻¹			1000 min ⁻¹		
						25°C	40°C	55°C	25°C	40°C	55°C	25°C	40°C	55°C
LS / LSES	160 M/MU*	2; 4; 6	6210 C3	6309 C3	13	22200	11100	5550	32400	16200	8100	39800	19900	9950
	160 L*													
	180 MR*	2	6210 C3	6310 C3	15	19600	9800	4900	-	-	-	-	-	-
	180 MT*	2; 4							30400	15200	7600			
	180 LR*	4							-	-	-			
	180 LUR*	4; 6							26800	13400	6700			
	180 M*	4	6212 C3	6310 C3	15	-	-	-	29200	14600	7300	-	-	-
	180 L*	6												
	200 LR*	2; 4; 6	6312 C3	6312 C3	20	15200	7600	3800	26800	13400	6700	35000	17500	8750
	200 LU*	4; 6												
	200 L*	2; 6	6214 C3	6312 C3	20	14600	7300	3650	-	-	-	34600	17300	8650
	225 ST*	4	6205 C3	6313 C3	25	-	-	-	25200	12600	6300	-	-	-
	225 MT*	2												
	225 SR/MR*	2; 4; 6	6312 C3	6313 C3	25	13400	6700	3350	25200	12600	6300	33600	16800	8400
	225 SG*	4	6216 C3	6314 C3	25	-	-	-	23600	11800	5900	-	-	-
	225 MG*	4; 6												
	250 MZ	2	6312 C3	6313 C3	25	13400	6700	3350	-	-	-	-	-	-
	250 ME	4; 6	6216 C3	6314 C3	25	-	-	-	23600	11800	5900	32200	16100	8050
	280 SC/MC	2												
	280 SC	6	6216 C3	6316 C3	35	-	-	-	-	-	-	32200	16100	8050
280 SD/MD	4; 6	6218 C3	6316 C3	35	-	-	-	20800	10400	5200	29600	14800	7400	
315 SN	2	6216 C3	6316 C3	35	5600	2800	1400	-	-	-	-	-	-	
315 MP	2	6317 C3	6317 C3	40	5200	2600	1300	-	-	-	-	-	-	
315 SP	4	6317 C3	6320 C3	50	-	-	-	15800	7900	3950	-	-	-	
315 MP/MR	4; 6													-

* bearing with grease nipples on request

STANDARD BEARING FITTING ARRANGEMENTS

LS / LSES series		Horizontal shaft	Vertical shaft	
			Shaft facing down	Shaft facing up
Foot mounted motors	Mounting arrangement	B3	V5	V6
	standard mounting	The DE bearing is: - located at DE for types ≤ 160 MP/MR/LR - locked for types ≥ 160 M/MU/L/LUR	The DE bearing is: - located at DE for types ≤ 160 MP/MR/LR - locked for types ≥ 160 M/MU/L/LUR	The DE bearing is locked for all motors
	on request	DE bearing locked for frame < 132	The DE bearing is locked	
Flange mounted motors (or foot and flange)	Mounting arrangement	B5 / B35 / B14 / B34	V1 / V15 / V18 / V58	V3 / V36 / V19 / V69
	standard mounting	The DE bearing is locked	The DE bearing is locked	The DE bearing is locked

IMfinity® 3-phase induction motors - IE2 - IE3 - IE4 - Non IE Efficiency

IP55 aluminium frame

Construction

Axial loads

HORIZONTAL MOTOR

For a bearing life L_{10h}
of 25,000 hours
and 40,000 hours

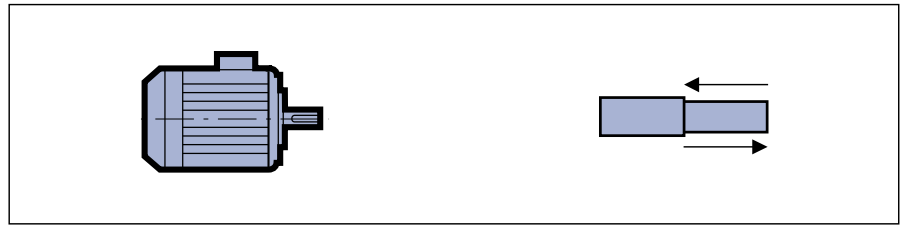

Series	Type	No. of poles	Permissible axial load (in daN) on main shaft extension for standard bearing assembly													
			3000 min ⁻¹						1500 min ⁻¹				1000 min ⁻¹			
			→		←		→		←		→		←			
			25,000 hours	40,000 hours	25,000 hours	40,000 hours	25,000 hours	40,000 hours	25,000 hours	40,000 hours	25,000 hours	40,000 hours	25,000 hours	40,000 hours		
LS	56	2; 4; 6	7	5	28	24	14	10	35	30	17	12	38	32		
	63	2; 4; 6	13	9	34	29	18	13	39	33	26	18	47	40		
	71	2; 4; 6	13	9	34	29	18	13	39	33	26	18	47	40		
LS / LSES	80 L	2	30	21	(60)	(51)	-	-	-	-	-	-	-	-		
	80 LG	2; 4	28	19	(68)	(59)	48	34	(88)	(74)	-	-	-	-		
	90 SL/L	2; 4; 6	29	23	(69)	(56)	45	32	(85)	(72)	56	40	(96)	(80)		
	90 LU	2; 4; 6	22	13	(72)	(63)	38	25	(88)	(75)	47	32	(97)	(82)		
	100 L	2; 6	42	28	(92)	(78)	-	-	-	-	78	57	(128)	(107)		
	100 LR	4	-	-	-	-	58	39	(108)	(90)	-	-	-	-		
	100 LG	4; 6	-	-	-	-	55	38	(105)	(88)	75	53	(125)	(103)		
	112 M	2	38	25	(88)	(75)	-	-	-	-	-	-	-	-		
	112 MG	2; 6	37	24	(87)	(74)	-	-	-	-	126	104	(76)	(54)		
	112 MU	4; 6	-	-	-	-	54	36	(114)	(96)	66	45	(126)	(105)		
	132 S	2; 6	69	49	(129)	(109)	-	-	-	-	124	93	(184)	(153)		
	132 SU	2; 4	65	46	(125)	(106)	99	73	(159)	(133)	-	-	-	-		
	132 SM/M	2; 4; 6	101	74	(171)	(144)	148	111	(218)	(181)	178	134	(248)	(204)		
	132 MU	4; 6	-	-	-	-	139	103	(219)	(183)	168	124	(248)	(204)		
	160 MP	2	140	104	(220)	(184)	-	-	-	-	-	-	-	-		
	160 MR	2; 4	131	95	(221)	(185)	193	145	(283)	(235)	-	-	-	-		
	160 M	2; 4; 6	132	96	232	196	187	140	287	240	235	179	335	279		
	160 MU	6	-	-	-	-	-	-	-	-	219	164	319	264		
	160 L	2; 4; 6	128	96	228	196	183	136	283	236	231	175	331	275		
	160 LUR	4; 6	-	-	-	-	213	159	313	259	257	193	357	293		
	180 M	4	-	-	-	-	228	174	291	237	-	-	-	-		
	180 MR	2	156	115	256	215	-	-	-	-	-	-	-	-		
	180 MT	2; 4	159	118	259	218	214	160	314	260	-	-	-	-		
	180 L	6	-	-	-	-	-	-	-	-	265	201	328	264		
	180 LR	4	-	-	-	-	203	150	303	250	-	-	-	-		
	180 LUR	4; 6	-	-	-	-	224	170	287	233	224	162	287	225		
	200 L	2; 6	244	190	310	256	-	-	-	-	362	278	428	344		
	200 LR	2; 4; 6	244	191	307	254	312	241	375	304	341	258	404	321		
	200 LU	4; 6	-	-	-	-	316	245	379	308	327	245	390	308		
	225 SG	4	-	-	-	-	411	321	481	391	-	-	-	-		
	225 SR	4	-	-	-	-	350	271	420	341	-	-	-	-		
	225 ST	4	-	-	-	-	372	292	438	358	-	-	-	-		
	225 MG	4; 6	-	-	-	-	407	317	477	387	535	426	605	496		
	225 MR	2; 4; 6	280	220	343	283	358	278	421	341	409	315	472	378		
	225 MT	2	281	221	347	287	-	-	-	-	-	-	-	-		
	250 ME	4; 6	-	-	-	-	400	311	470	381	471	365	541	435		
	250 MZ	2	277	217	340	280	-	-	-	-	-	-	-	-		
	280 SC	2; 6	303	236	373	306	-	-	-	-	461	355	531	425		
	280 SD	4	-	-	-	-	454	349	542	437	-	-	-	-		
	280 MC	2	300	233	370	303	-	-	-	-	-	-	-	-		
280 MD	4; 6	-	-	-	-	446	342	534	430	524	401	612	489			
315 SN	2	357	279	427	349	-	-	-	-	-	-	-	-			
315 SP	4; 6	-	-	-	-	814	671	634	491	950	780	770	600			
315 MP	2; 4; 6	487	405	307	225	768	628	588	448	917	749	737	569			
315 MR	4; 6	-	-	-	-	770	630	590	450	864	699	684	519			

(): axial loads permissible with DE bearing locked

IMfinity® 3-phase induction motors - IE2 - IE3 - IE4 - Non IE Efficiency

IP55 aluminium frame

Construction

Axial loads

VERTICAL MOTOR SHAFT FACING DOWN

For a bearing life L_{10h}
of 25,000 hours
and 40,000 hours

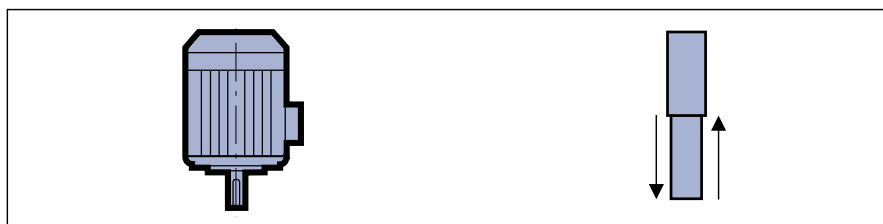

Series	Type	No. of poles	Permissible axial load (in daN) on main shaft extension for standard bearing assembly											
			3000 min ⁻¹				1500 min ⁻¹				1000 min ⁻¹			
			25,000 hours	40,000 hours	25,000 hours	40,000 hours	25,000 hours	40,000 hours	25,000 hours	40,000 hours	25,000 hours	40,000 hours	25,000 hours	40,000 hours
IM V5 IM V1 / V15 IM V18 / V58														
LS	56	2; 4; 6	6	4	24	20	13	9	36	30	16	11	39	33
	63	2; 4; 6	11	8	36	30	16	11	41	35	24	17	49	42
	71	2; 4; 6	11	8	36	30	16	11	41	35	24	17	49	42
	80 L	2	29	20	(63)	(54)	-	-	-	-	-	-	-	-
	80 LG	2; 4	26	16	(72)	(62)	45	32	(93)	(78)	-	-	-	-
	90 SL/L	2; 4; 6	26	16	(73)	(63)	42	28	(91)	(78)	53	37	(101)	(86)
	90 LU	2; 4; 6	19	9	(77)	(67)	33	20	(95)	(82)	43	28	(105)	(89)
	100 L	2; 6	38	24	(98)	(85)	-	-	-	-	73	52	(137)	(115)
	100 LR	4	-	-	-	-	52	34	(117)	(99)	-	-	-	-
	100 LG	4; 6	-	-	-	-	48	31	(116)	(99)	68	46	(137)	(115)
	112 M	2	35	21	(95)	(81)	-	-	-	-	-	-	-	-
	112 MG	2; 6	31	18	(98)	(85)	-	-	-	-	68	47	(138)	(116)
	112 MU	4; 6	-	-	-	-	45	28	(128)	(110)	57	36	(140)	(119)
	132 S	2; 6	61	41	(142)	(122)	-	-	-	-	115	84	(200)	(169)
	132 SU	2; 4	57	37	(139)	(120)	90	63	(176)	(149)	-	-	-	-
	132 SM/M	2; 4; 6	90	62	(189)	(161)	137	100	(237)	(200)	165	121	(270)	(226)
	132 MU	4; 6	-	-	-	-	125	89	(242)	(206)	152	108	(273)	(230)
	160 MP	2	126	90	(243)	(207)	-	-	-	-	-	-	-	-
	160 MR	2; 4	115	80	(246)	(210)	175	127	(311)	(264)	-	-	-	-
	160 M	2; 4; 6	111	75	264	229	164	117	326	278	210	154	375	319
	160 MU	6	-	-	-	-	-	-	-	-	189	133	375	319
	160 L	2; 4; 6	106	70	263	228	160	113	322	274	208	151	371	314
	160 LUR	4; 6	-	-	-	-	186	131	363	309	227	162	417	352
	180 M	4	-	-	-	-	187	132	361	306	-	-	-	-
	180 MR	2	131	90	296	255	-	-	-	-	-	-	-	-
	180 MT	2; 4	136	95	295	254	189	134	360	305	-	-	-	-
	180 L	6	-	-	-	-	-	-	-	-	226	161	398	334
	180 LR	4	-	-	-	-	177	122	355	300	-	-	-	-
	180 LUR	4; 6	-	-	-	-	187	132	355	300	183	120	377	314
	200 L	2; 6	194	139	384	330	-	-	-	-	308	223	524	439
	200 LR	2; 4; 6	209	154	360	306	275	203	445	373	299	215	496	412
	200 LU	4; 6	-	-	-	-	262	190	471	398	269	186	505	422
225 SG	4	-	-	-	-	335	244	616	524	-	-	-	-	
225 SR	4	-	-	-	-	294	213	520	439	-	-	-	-	
225 ST	4	-	-	-	-	322	241	519	438	-	-	-	-	
225 MG	4; 6	-	-	-	-	324	232	621	530	456	345	749	638	
225 MR	2; 4; 6	234	173	413	352	302	221	520	439	348	253	587	492	
225 MT	2	240	179	410	349	-	-	-	-	-	-	-	-	
250 ME	4; 6	-	-	-	-	305	214	632	541	378	270	712	604	
250 MZ	2	228	168	417	356	-	-	-	-	-	-	-	-	
280 SC	2; 6	233	165	488	420	-	-	-	-	348	240	728	621	
280 SD	4	-	-	-	-	340	233	738	632	-	-	-	-	
280 MC	2	221	153	496	428	-	-	-	-	-	-	-	-	
280 MD	4; 6	-	-	-	-	319	213	745	639	391	265	853	728	
315 SN	2	268	188	571	491	-	-	-	-	-	-	-	-	
315 SP	4; 6	-	-	-	-	620	475	923	778	748	575	1074	901	
315 MP	2; 4; 6	333	249	541	456	541	397	959	815	695	524	1088	917	
315 MR	4; 6	-	-	-	-	537	393	966	822	591	420	1151	981	

(): axial loads permissible with DE bearing locked

IMfinity® 3-phase induction motors - IE2 - IE3 - IE4 - Non IE Efficiency

IP55 aluminium frame

Construction

Axial loads

VERTICAL MOTOR SHAFT FACING UP

For a bearing life L_{10h}
of 25,000 hours
and 40,000 hours



Series	Type	No. of poles	Permissible axial load (in daN) on main shaft extension for standard bearing assembly											
			3000 min ⁻¹				1500 min ⁻¹				1000 min ⁻¹			
			25,000 hours	40,000 hours	25,000 hours	40,000 hours	25,000 hours	40,000 hours	25,000 hours	40,000 hours	25,000 hours	40,000 hours	25,000 hours	40,000 hours
LS	56	2; 4; 6	8	5	27	23	15	10	34	29	18	13	39	33
	63	2; 4; 6	15	10	32	22	20	18	37	31	28	20	45	38
	71	2; 4; 6	15	10	32	22	20	18	37	31	28	20	45	38
	80 L	2	(59)	(50)	33	24	-	-	-	-	-	-	-	-
	80 LG	2; 4	(66)	(56)	32	22	(85)	(71)	53	39	-	-	-	-
	90 SL/L	2; 4; 6	(66)	(56)	33	23	(82)	(68)	51	38	(93)	(77)	61	46
	90 LU	2; 4; 6	(69)	(59)	27	18	(83)	(70)	45	32	(93)	(77)	54	39
	100 L	2; 6	(88)	(74)	48	35	-	-	-	-	(123)	(102)	87	65
	100 LR	4	-	-	-	-	(102)	(84)	67	49	-	-	-	-
	100 LG	4; 6	-	-	-	-	(98)	(81)	67	49	(118)	(96)	87	66
	112 M	2	(84)	(71)	45	31	-	-	-	-	-	-	-	-
	112 MG	2; 6	(81)	(68)	48	35	-	-	-	-	(118)	(97)	88	66
	112 MU	4; 6	-	-	-	-	(105)	(88)	68	50	(117)	(96)	80	60
	132 S	2; 6	(121)	(101)	82	62	-	-	-	-	(175)	(143)	140	109
	132 SU	2; 4	(117)	(97)	79	60	(150)	(123)	116	89	-	-	-	-
132 SM/M	2; 4; 6	(160)	(132)	119	91	(207)	(170)	167	130	(235)	(191)	200	156	
132 MU	4; 6	-	-	-	-	(206)	(169)	163	126	(232)	(188)	193	150	
160 MP	2	(206)	(170)	163	127	-	-	-	-	-	-	-	-	
160 MR	2; 4	(205)	(170)	156	120	(265)	(217)	222	174	-	-	-	-	
160 M	2; 4; 6	211	175	164	129	264	217	226	178	310	254	275	219	
160 MU	6	-	-	-	-	-	-	-	-	289	233	275	219	
160 L	2; 4; 6	206	170	163	128	260	213	222	174	308	251	271	214	
160 LUR	4; 6	-	-	-	-	286	231	263	209	327	262	317	252	
180 M	4	-	-	-	-	250	195	298	243	-	-	-	-	
180 MR	2	231	190	196	155	-	-	-	-	-	-	-	-	
180 MT	2; 4	236	195	195	154	289	234	260	205	-	-	-	-	
180 L	6	-	-	-	-	-	-	-	-	289	224	335	271	
180 LR	4	-	-	-	-	277	222	255	200	-	-	-	-	
180 LUR	4; 6	-	-	-	-	250	195	292	237	246	183	314	251	
200 L	2; 6	260	205	318	264	-	-	-	-	374	289	458	373	
200 LR	2; 4; 6	272	217	297	243	338	266	382	310	362	278	433	349	
200 LU	4; 6	-	-	-	-	325	253	408	335	332	249	442	359	
225 SG	4	-	-	-	-	405	314	546	454	-	-	-	-	
225 SR	4	-	-	-	-	364	283	450	369	-	-	-	-	
225 ST	4	-	-	-	-	388	307	453	372	-	-	-	-	
225 MG	4; 6	-	-	-	-	394	302	551	460	526	415	679	568	
225 MR	2; 4; 6	297	236	350	289	365	284	457	376	411	316	524	429	
225 MT	2	306	245	344	283	-	-	-	-	-	-	-	-	
250 ME	4; 6	-	-	-	-	375	284	562	471	448	340	642	534	
250 MZ	2	291	231	354	293	-	-	-	-	-	-	-	-	
280 SC	2; 6	303	235	418	350	-	-	-	-	418	310	658	551	
280 SD	4	-	-	-	-	428	321	650	544	-	-	-	-	
280 MC	2	291	223	426	358	-	-	-	-	-	-	-	-	
280 MD	4; 6	-	-	-	-	407	301	657	551	479	353	765	640	
315 SN	2	338	258	501	421	-	-	-	-	-	-	-	-	
315 SP	4; 6	-	-	-	-	440	295	1103	958	568	395	1254	1081	
315 MP	2; 4; 6	153	69	721	636	361	217	1139	995	515	344	1268	1097	
315 MR	4; 6	-	-	-	-	357	213	1146	1002	411	240	1331	1161	

(): axial loads permissible with DE bearing locked

STANDARD FITTING ARRANGEMENT

Permissible radial load on main shaft extension with a bearing life L_{10h} of 25,000 hours.

FR : Radial Force

X: Distance with respect to the shaft shoulder

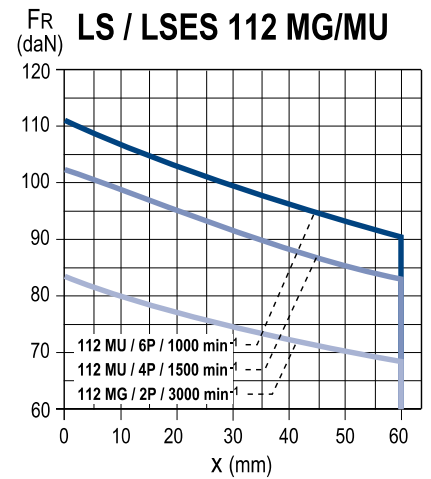
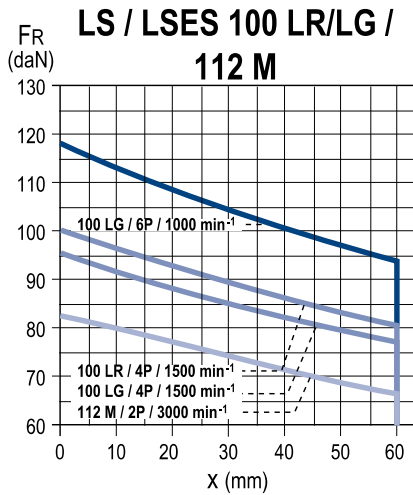
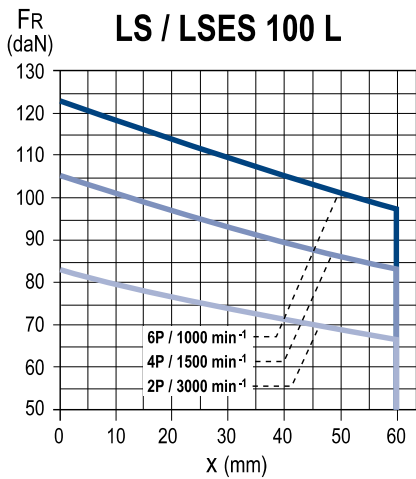
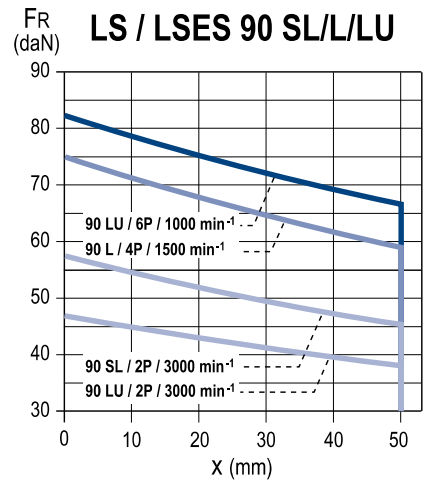
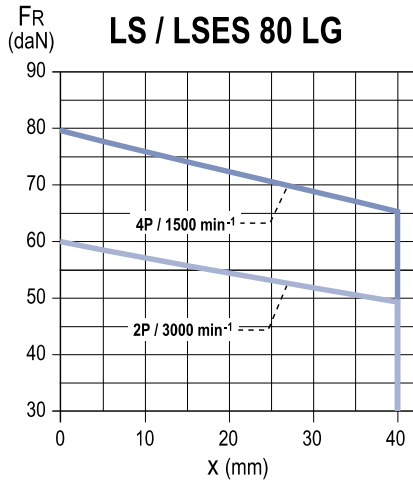
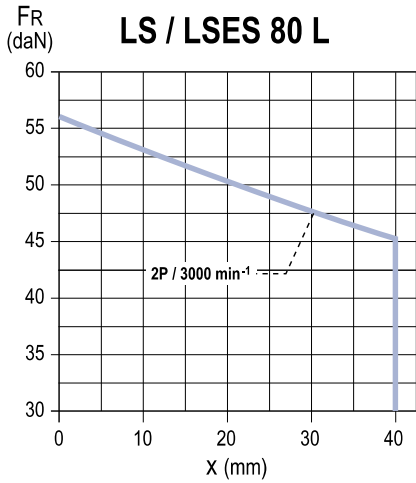
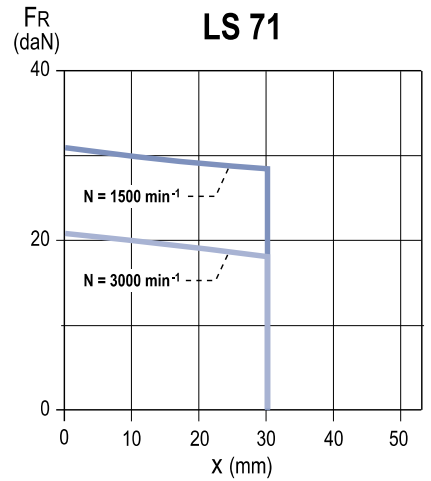
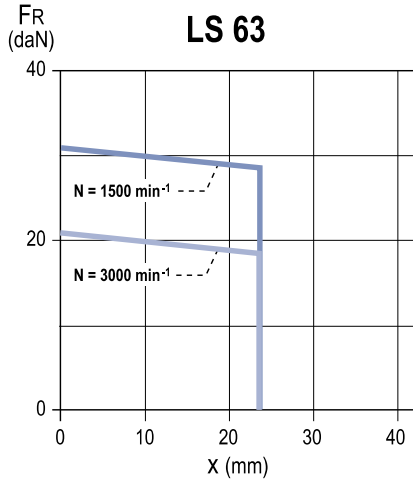
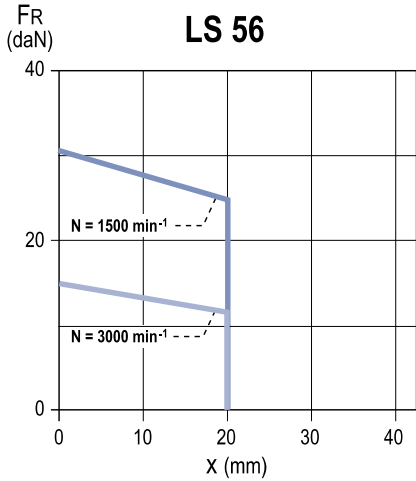

STANDARD FITTING ARRANGEMENT

Permissible radial load on main shaft extension with a bearing life L_{10h} of 25,000 hours.

FR : Radial Force

X: Distance with respect to the shaft shoulder

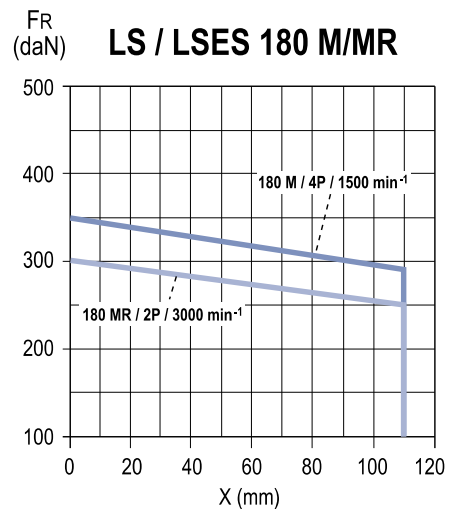
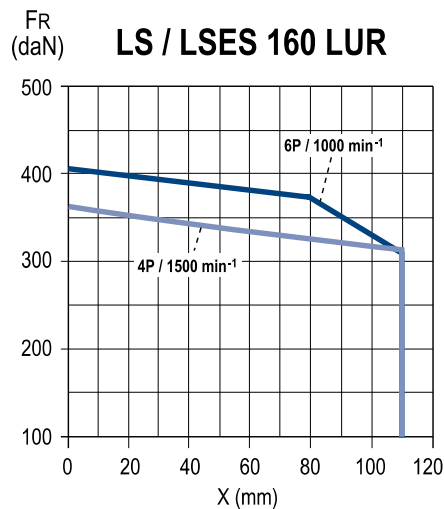
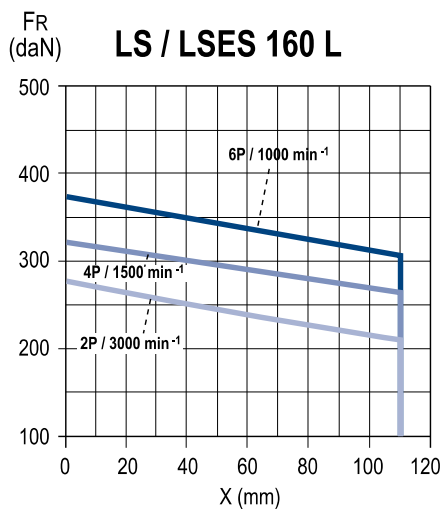
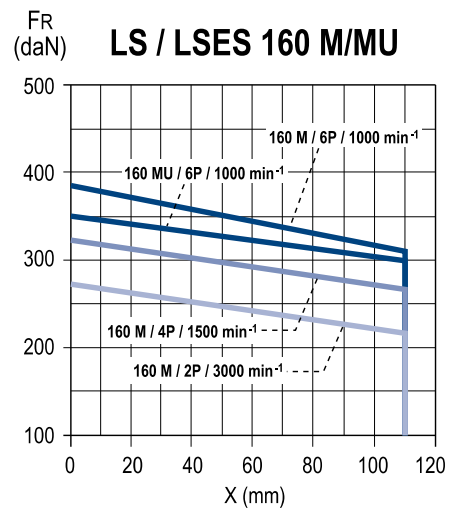
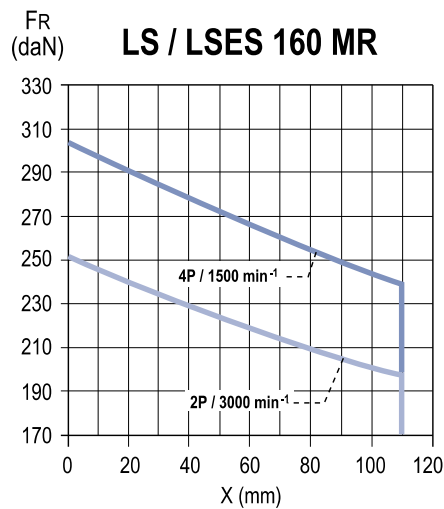
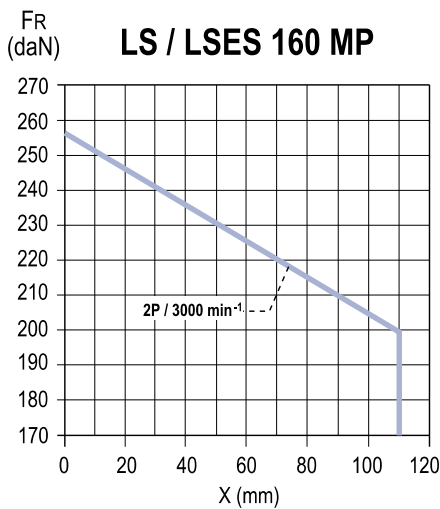
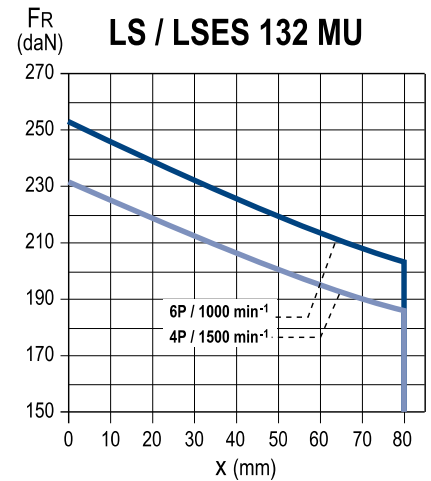
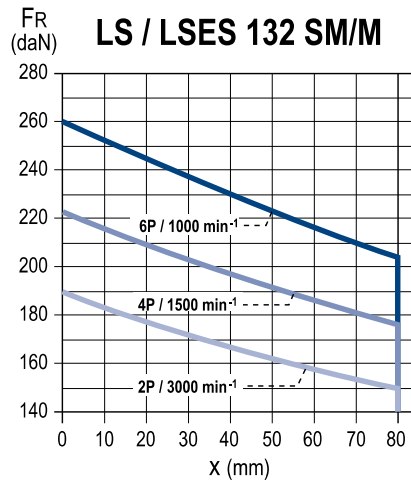
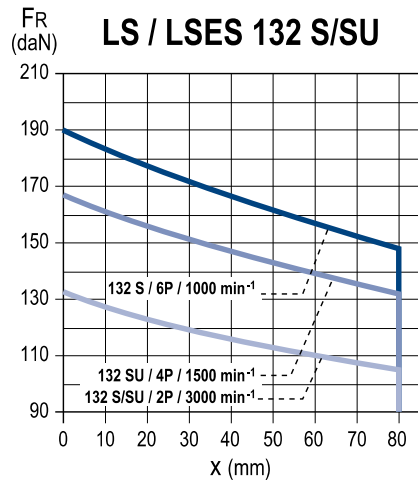

STANDARD FITTING ARRANGEMENT

Permissible radial load on main shaft extension with a bearing life L_{10h} of 25,000 hours.

FR : Radial Force

X: Distance with respect to the shaft shoulder

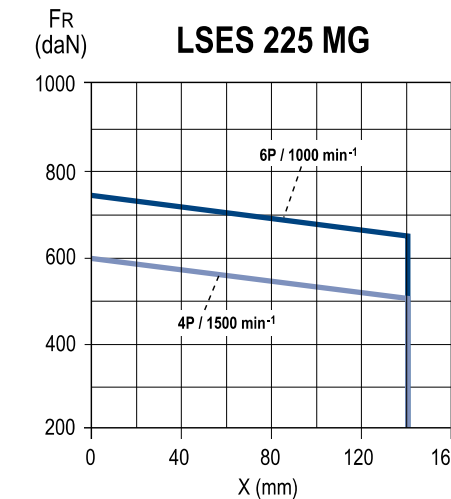
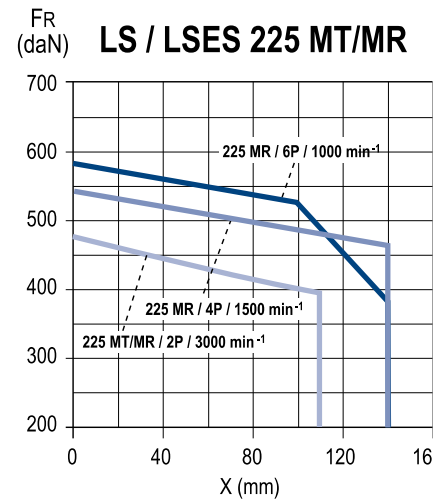
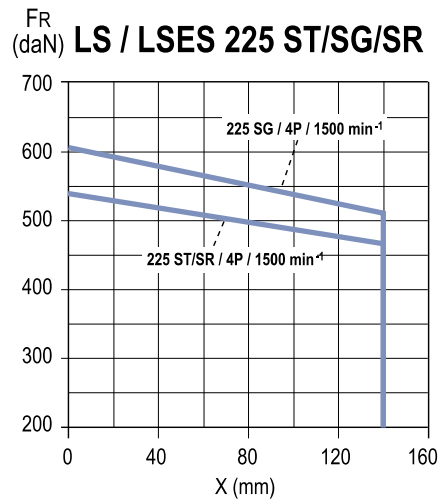
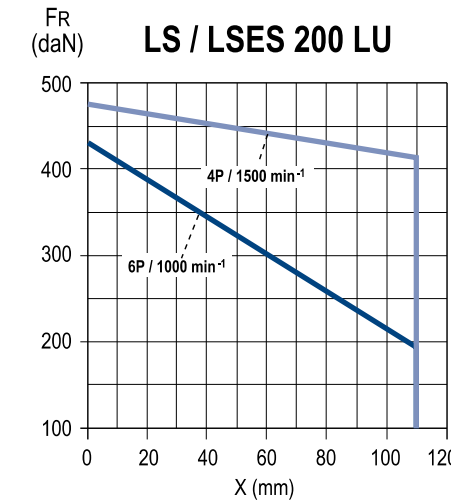
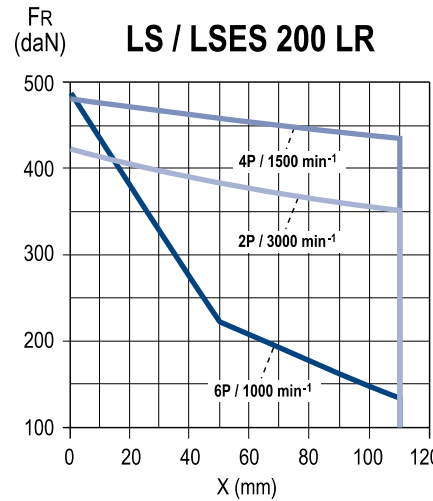
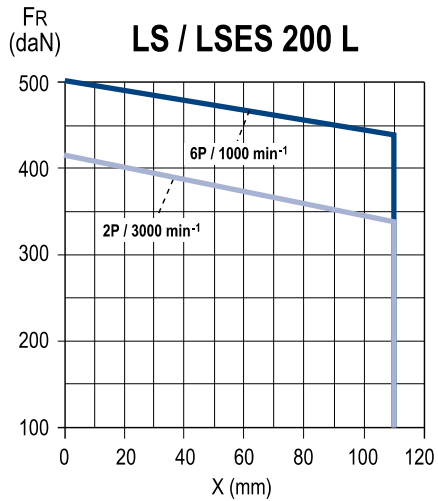
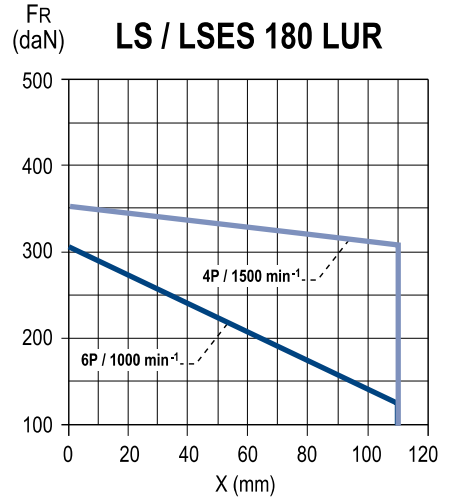
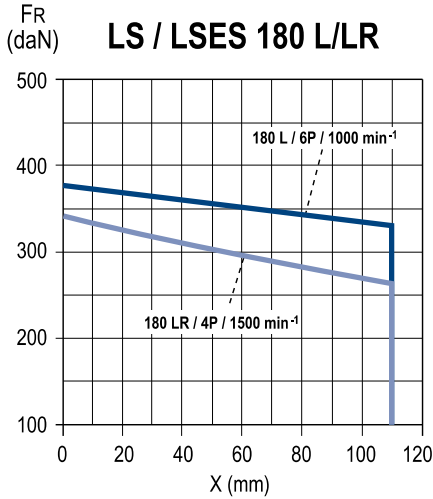
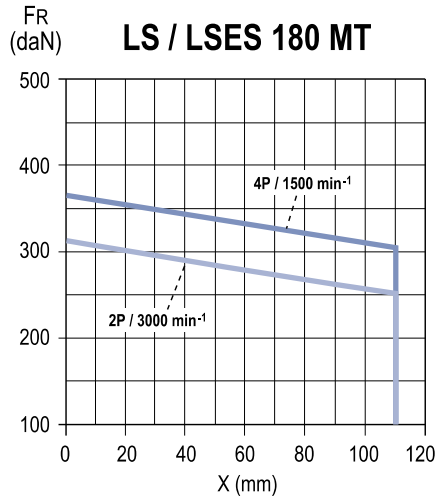

IMfinity® 3-phase induction motors - IE2 - IE3 - IE4 - Non IE Efficiency

IP55 aluminium frame

Construction

Radial loads

STANDARD FITTING ARRANGEMENT

Permissible radial load on main shaft extension with a bearing life L_{10h} of 25,000 hours.

FR : Radial Force

X: Distance with respect to the shaft shoulder

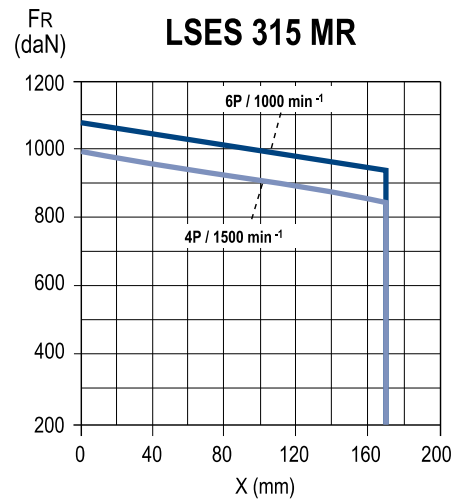
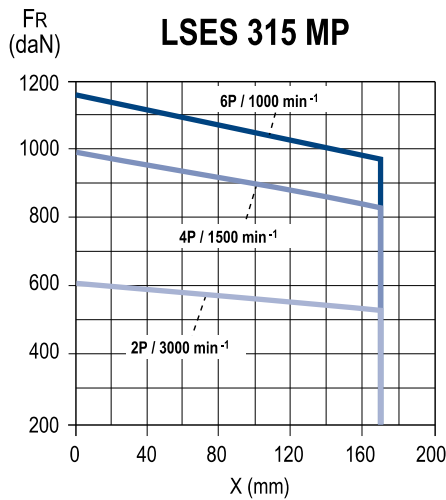
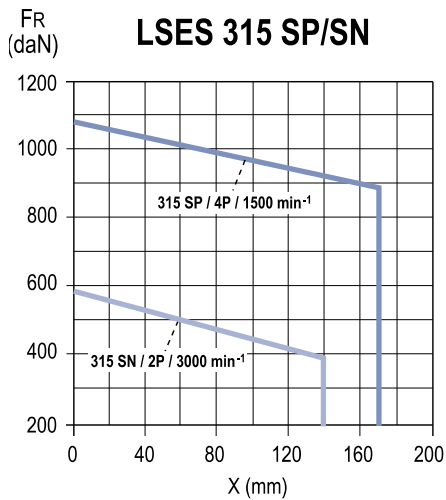
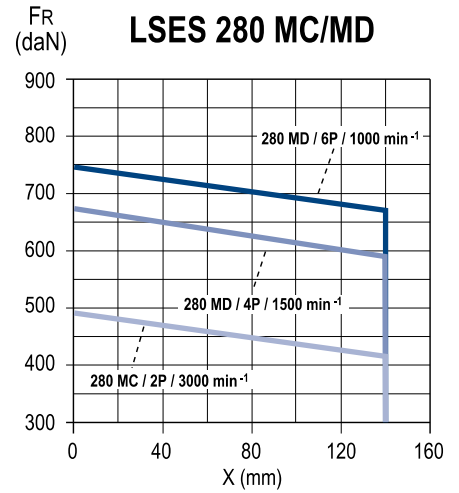
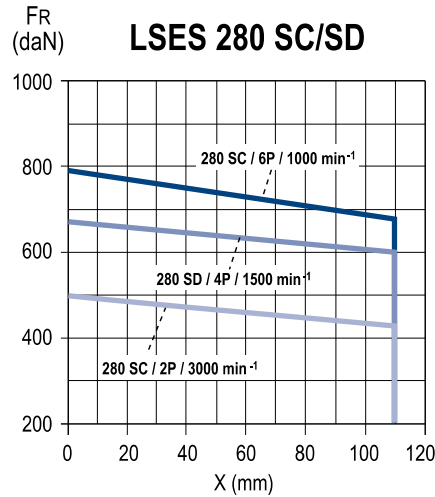
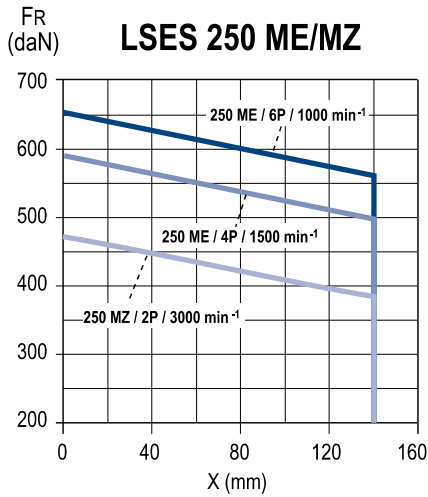

IMfinity® 3-phase induction motors - IE2 - IE3 - IE4 - Non IE Efficiency

IP55 aluminium frame

Construction

Radial loads

SPECIAL FITTING ARRANGEMENT

Type of drive end roller bearings

Series	Type	No. of poles	Non drive end bearing (N.D.E.)	Drive end bearing (D.E.)
LS / LSES	160 M/MU	4; 6	6210 C3	NU 309
	160 L			
	180 MT	4	6210 C3	NU 310
	180 LR			
	180 LUR	4; 6	6312 C3	NU 310
	180 M	4	6212 C3	NU 310
	180 L	6		
	200 L	6	6214 C3	NU 312
	200 LR	4; 6	6312 C3	NU 312
	200 LU			
	225 ST	4	6214 C3	NU 313
	225 SR/MR	4; 6	6312 C3	NU 313
	225 SG	4	6216 C3	NU 314
	225 MG	4; 6		
	250 ME	4; 6	6216 C3	NU 314
	280 SC	6	6216 C3	NU 316
	280 SD/MD	4; 6	6218 C3	NU 316
	315 SP	4	6317 C3	NU 320
315 MP/MR	4; 6			

SPECIAL FITTING ARRANGEMENT

Permissible radial load on main shaft extension with a bearing life L_{10h} of 25,000 hours.

FR : Radial Force

X: Distance with respect to the shaft shoulder

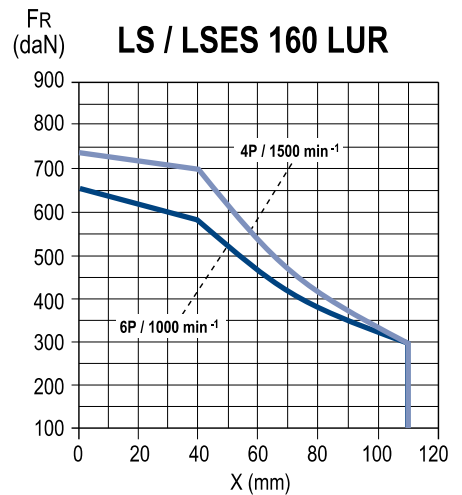
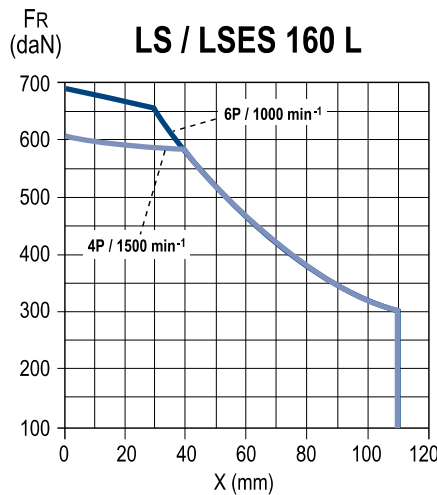
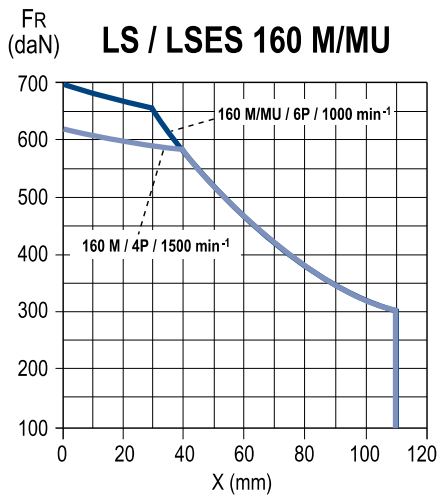

SPECIAL FITTING ARRANGEMENT

Permissible radial load on main shaft extension with a bearing life L_{10h} of 25,000 hours.

FR : Radial Force

X: Distance with respect to the shaft shoulder

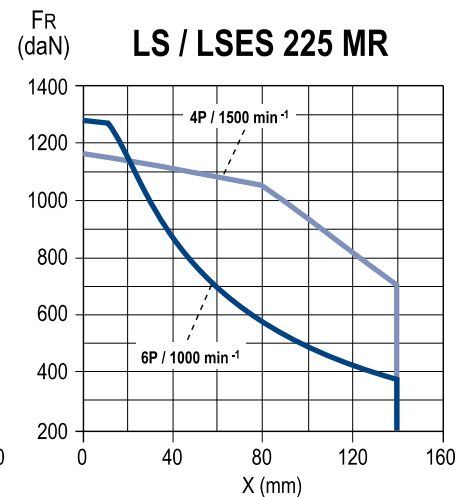
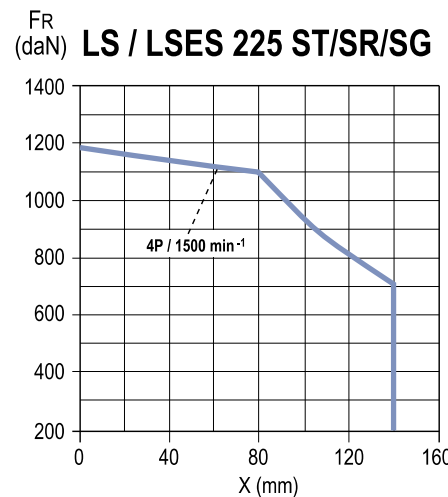
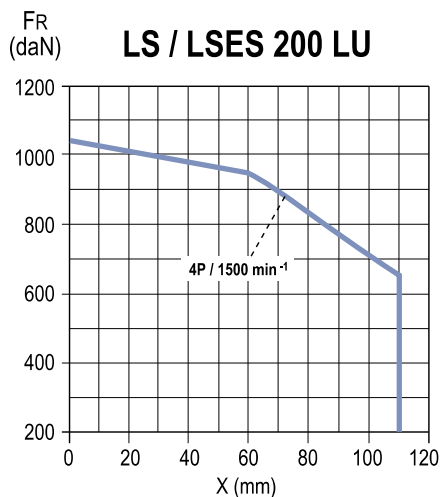
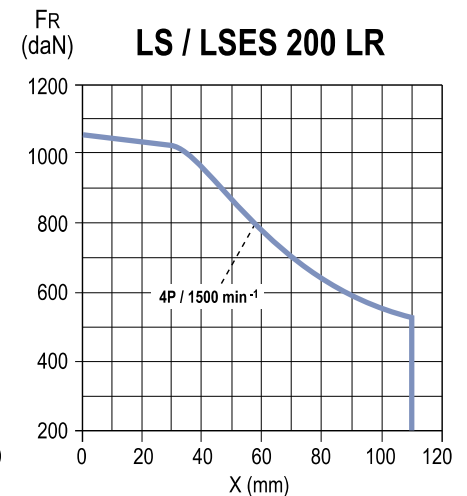
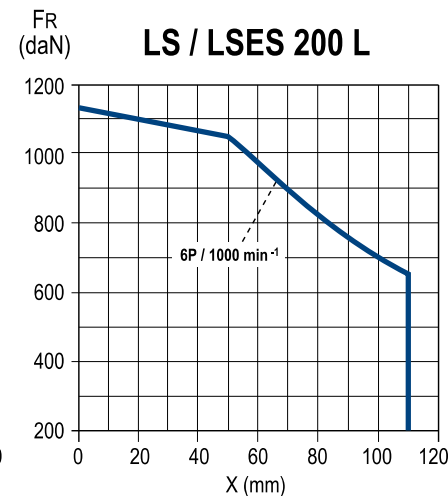
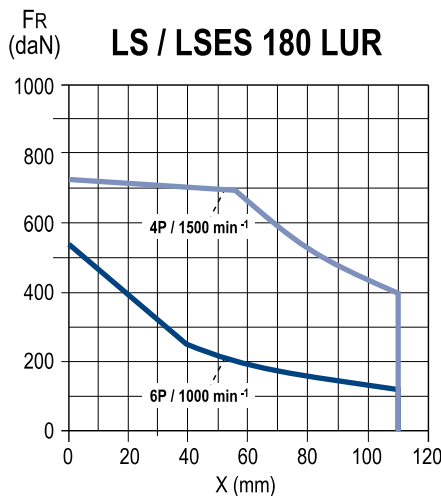
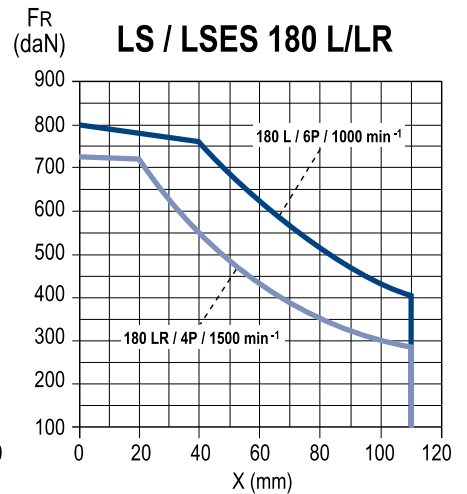
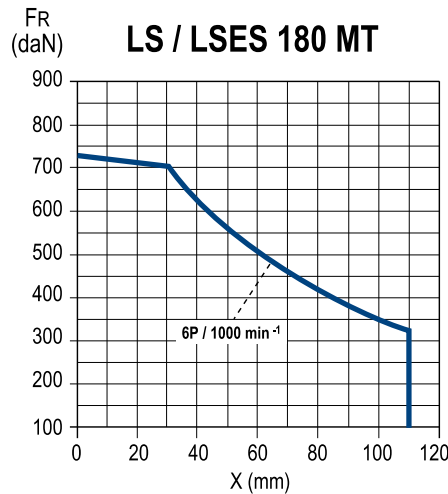
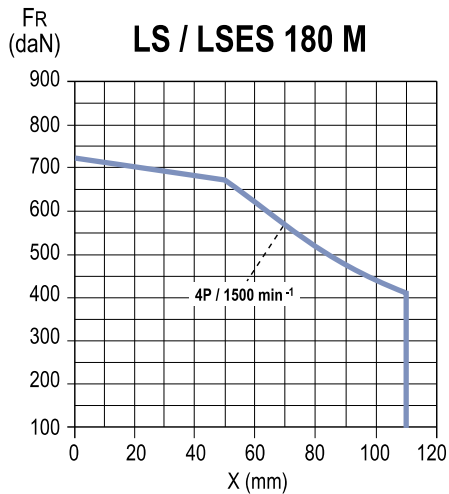

SPECIAL FITTING ARRANGEMENT

Permissible radial load on main shaft extension with a bearing life L_{10h} of 25,000 hours.

FR : Radial Force

X: Distance with respect to the shaft shoulder

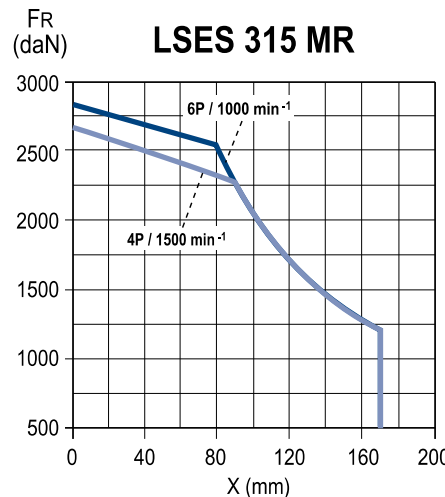
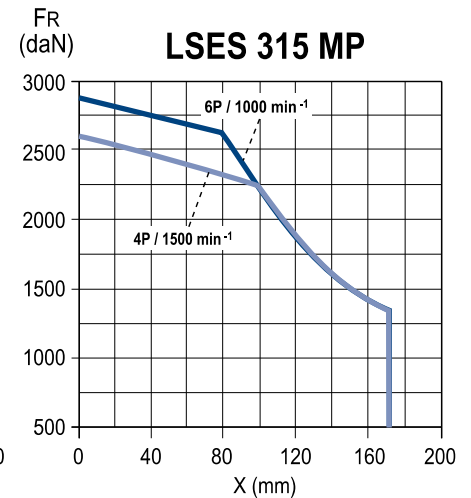
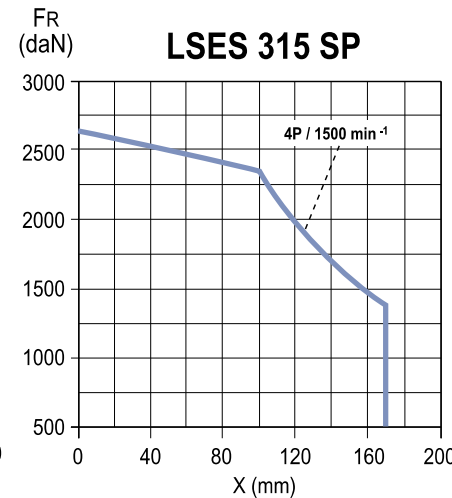
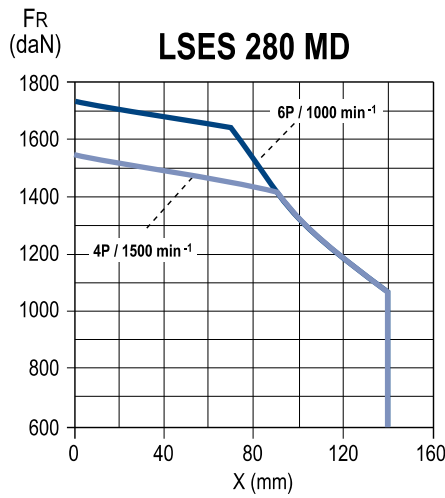
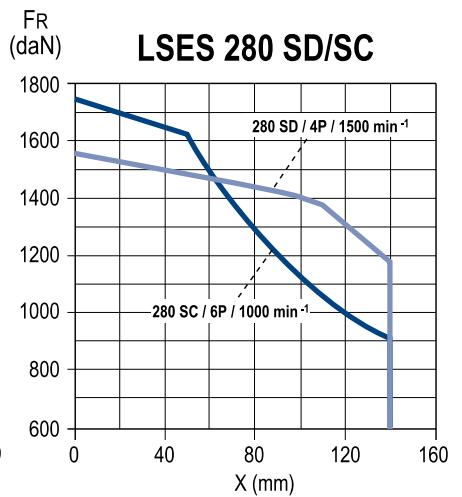
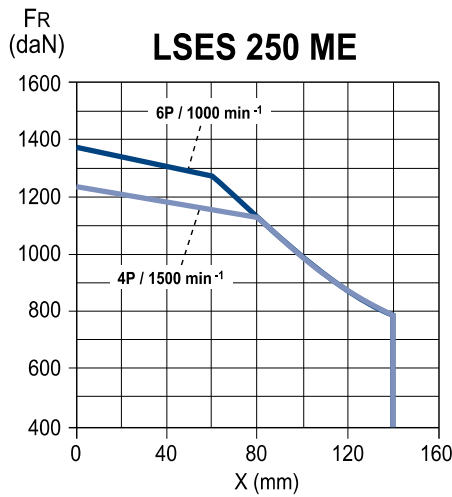
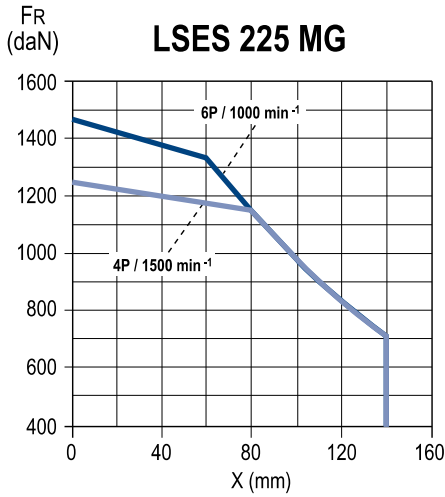

IMfinity® 3-phase induction motors - IE2 - IE3 - IE4 - Non IE Efficiency

IP55 aluminium frame

Optional features

Non-standard flanges

Optionally, Leroy-Somer motors can be fitted with flanges and faceplates that are larger or smaller than standard. This means that motors can be adapted to all types of situation without the need for costly and time-consuming modifications.

The tables below give the flange and faceplate dimensions and also indicate flange/motor compatibility.

The bearing and shaft extension for each frame size remain standard.

Dimensions in millimetres

(FF) Flange mounted

IEC symbol	Flange dimensions						
	M	N	P	T	n	S	LA
FF 100	100	80	120	2.5	4	7	5
FF 115	115	95	140	3	4	10	10
FF 130	130	110	160	3.5	4	10	10
FF 165	165	130	200	3.5	4	12	10
FF 215	215	180	250	4	4	15	12
FF 265	265	230	300	4	4	15	14
FF 300	300	250	350	5	4	18.5	14
FF 350	350	300	400	5	4	18.5	15
FF 400	400	350	450	5	8	18.5	16
FF 500	500	450	550	5	8	18.5	18
FF 600*	600	550	660	6	8	24	22

* Tolerance N js6

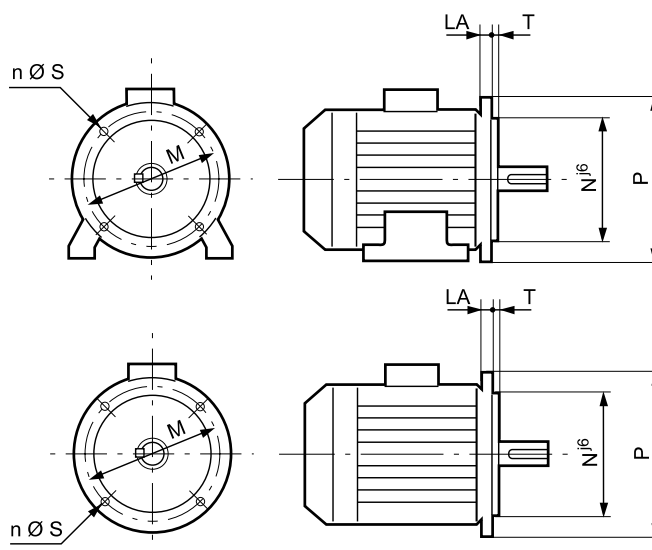

(FT) Face mounted

IEC symbol	Faceplate dimensions						
	M	N	P	T	n	M.S	
FT 65	65	50	80	2.5	4	M5	
FT 75	75	60	90	2.5	4	M5	
FT 85	85	70	105	2.5	4	M6	
FT 100	100	80	120	3	4	M6	
FT 115	115	95	140	3	4	M8	
FT 130	130	110	160	3.5	4	M8	
FT 165	165	130	200	3.5	4	M10	
FT 215	215	180	250	4	4	M12	
FT 265	265	230	300	4	4	M12	

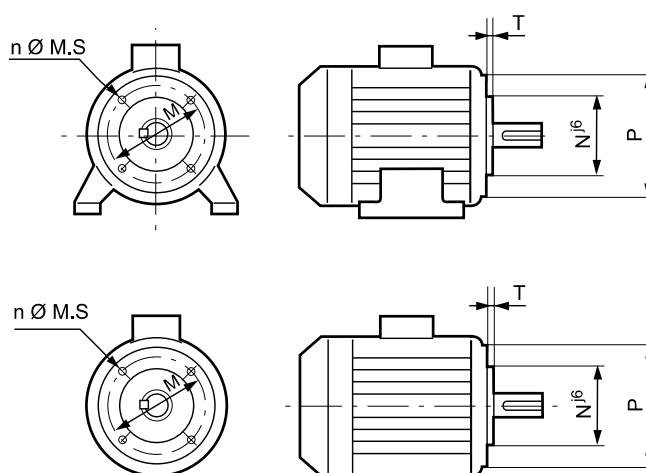

IMfinity® 3-phase induction motors - IE2 - IE3 - IE4 - Non IE Efficiency

IP55 aluminium frame

Optional features

Mechanical options

MODIFIED FLANGES

Motor type	Flange type Mounting forms	(FF) Flange mounted											(FT) Face mounted									
		FF 85	FF 100	FF 115	FF 130	FF 165	FF 215	FF 265	FF 300	FF 350	FF 400	FF 500	FF 600	FT 65	FT 75	FT 85	FT 100	FT 115	FT 130	FT 165	FT 215	FT 265
56 L	all		●										●	◆	◆	●						
63 M	all	■	■	●	◆								◆	●	◆	◆	◆					
71 L	all	■	■	■	●	◆							◆	◆	●	◆	◆	◆				
80 L	all	■	■	■	■	●	◆						◆	◆	◆	●	◆	◆	◆			
80 LG	B5/B35 ⁽¹⁾	◆	◆	◆	◆	●	◆	■							◆	●	◆	■	◆	◆	■	
80 LG	B3/B14/B34	■	■	■	■	■	■	■							◆	●	◆	◆	◆	◆	■	
90 SL/L/LU	B5/B35 ⁽¹⁾	◆	◆	◆	◆	●	◆	■							◆	◆	●	■	◆	◆	■	
90 SL/L/LU	B3/B14/B34	■	■	■	■	■	■	■							◆	◆	●	◆	◆	◆	■	
100 L/LR	all	■	■	■	■	■	●	■							◆	◆	◆	●	◆	◆	◆	
100 LG	all				■	■	●	◆									◆	●	◆	◆	◆	
112 M/MR	all	■	■	■	■	■	●	■								◆	◆	◆	●	◆	◆	
112 MG/MU	all				■	■	●	◆									◆	●	◆	◆	◆	
132 S/SU	all					■	◆	●										◆	●	◆	◆	
132 SM/M/MU	all					■	■	●	◆									■	●	■	■	
160 MR/LR/MP	all						◆	■	●	■											●	
160 M/MU/L/LUR	all							◆	●	◆												
180	all							◆	●	◆	◆ ⁽¹⁾											
200	all							◆	●	◆	◆											
225	all								●	◆	◆											
250	all									◆	●											
280	all									◆	●	◆										
315	all										●											

● Standard ■ Adapted shaft ◆ Adaptable without shaft modifications ⁽¹⁾ Dimension C need not comply with IEC 60072

DRIP COVER FOR OPERATION IN VERTICAL POSITION, SHAFT END FACING DOWN

Dimensions in millimetres

Motor type	LB'	∅
80	LB + 20	145
90	LB + 20	185
100	LB + 20	185
112 MR	LB + 20	185
112 MG/MU	LB + 25	210
132 S/SU	LB + 25	210
132 M/MU	LB + 30	240
160 MP/LR	LB + 30	240
160 M/L/LU	LB + 36.5	265
180 MT/LR	LB + 36.5	265
180 L	LB + 36.5	305
200 LR	LB + 36.5	305
200 L	LB + 36.5	350
225	LB + 36.5	350
250 MZ	LB + 36.5	350
250 ME	LB + 55	420
280	LB + 55	420
315 SN	LB + 55	420
315 SP/MP/MR	LB + 76.5	505

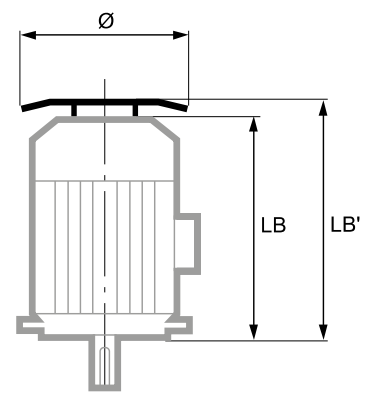

IMfinity® 3-phase induction motors - IE2 - IE3 - IE4 - Non IE Efficiency

IP55 aluminium frame

Optional features

Mechanical and electrical options

BRAKE MOTORS, FORCED VENTILATION

The integration of high-efficiency motors within a process often requires accessories to make operation easier:

- Forced ventilation for motors used at high or low speeds.
- Holding brakes for maintaining the rotor in the stop position without needing to leave the motor switched on.
- Emergency stop brakes to immobilise loads in case of failure of the motor torque control or loss of power supply.

Notes:

- Without forced ventilation, there is a possibility of overspeed with optional class B balancing.
- The motor temperature is monitored by sensors built into the windings.

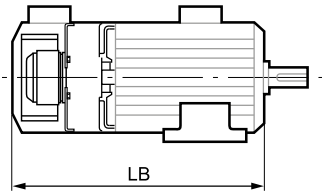

LSES series	LB dimensions with Forced Ventilation	
	Foot or face mounted motors	Flange mounted motor
80 L	317	
80 LG	331	351
90 S	304	324
90 L	331	351
100 L	373	
100 LR	373	
112 MR	412	
112 MG	412	
112 MU	412	
132 S	453	
132 SU	453	
132 M	458	
132 MU	458	
160 MP	709	
160 MR	730	
160 L	730	
160 M	687	
180 MT	702	
180 LR	702	
180 L	741	
200 LR	796	
200 L	802	
225 MR	853.5	
225 ST	853.5	
225 MT	808.5	
250 ME	1012	
250 MZ	853.5	
280 MD	1072	
280 SC	1012	
280 MC	1012	
315 SN	1072	
315 SP	1181	
315 MP	1181	
315 MR	1251	

MOTORS WITH SPACE HEATERS

Type	Power (W)
80 L	16
80 LG to 160 MP/LR	25
160 M/L to 225 ST/MT/MR	52
250 MZ	52
250 ME/MF	84
280 SC/MC/MD	84
315 SN	84
315 MP/MR	108

The space heaters use 200/240 V single-phase, 50 or 60 Hz.

MOTORS WITH REMOVABLE CONNECTOR

The removable connector option allows quick, safe and simple motor connection.

It can be used in numerous processes (automotive, food industries, etc.) where machine changeover times need to be kept to a minimum.

The male part of the connector is fitted instead of or on the motor terminal box, depending on which other options are selected. The connector socket is connected to the stator coils.

The female part of the connector is connected to the mains supply.

Up to 10 contacts can be mounted on the connectors, to cover power ratings up to 11 kW within an acceptable maximum current of 40 A.

For higher power ratings, please consult Leroy-Somer.



INTEGRATED VARIABLE SPEED MOTORS: VARMECA

Varmeca is a flux vector drive operating on all mains supplies (200 Volts to 480 Volts 50/60 Hz).

It is mounted instead of the terminal box in its position.

The drive allows low-speed operation at constant torque and high-speed operation at constant power (forced ventilation option mandatory).

In all circumstances, the Varmeca can be used to manage PTC and PTO motor sensors.

The variable speed drive offers a decentralised solution on the machine, the product being designed to operate in industrial conditions (resin-encapsulated electronics).

Numerous options can be incorporated: local speed control, FWD and REV operation, display unit, braking resistor, fieldbus.

Varmeca complies with the European CE marking standards and North American standards, UL for the USA and c(UL)us for Canada.



IMfinity® 3-phase induction motors - IE2 - IE3 - IE4 - Non IE Efficiency

IP55 aluminium frame

Installation and maintenance

Position of the lifting rings

LIFTING THE MOTOR ONLY (not coupled to the machine)

The regulations stipulate that over 25 kg, suitable handling equipment must be used.

All our motors are fitted with grab handles, making them easier to handle without risk. A diagram of the sling hoisting method appears below with the required dimensions.

To prevent any damage to the motor during handling (for example: switching the motor from horizontal to vertical), it is essential to follow these instructions.

HORIZONTAL POSITION

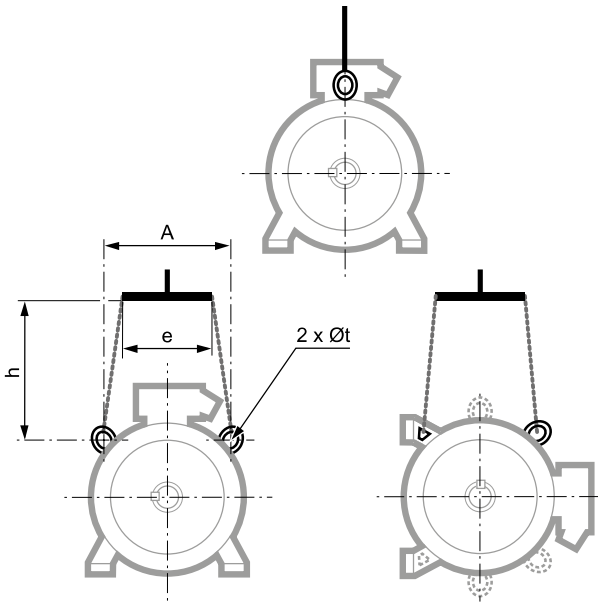

LS/LSES Series	Horizontal position			
	A	e min	h min	Øt
100 L/LR/LG	165	165	150	9
112 M/MR	165	165	150	9
112 MG/MU	-	-	-	9
132 S/SU	180	180	150	9
132 M/MU	200	180	150	14
160 MP/MR/LR	200	180	110	14
160 M/MU/L/LUR	200	260	150	14
180 M/MUR/L/LUR	200	260	150	14
200 L/LR	270	260	150	14
200 LU	270	260	150	14
225 SR/MR	270	260	150	14
225 S/SG/M/MG	360	380	200	30
250 MZ	360	380	200	30
250 ME	400	400	500	30
280 SC/SD/MC/MD	400	400	500	30
315 SN	400	400	500	30
315 SP/MP/MR	360	380	500	17

VERTICAL POSITION

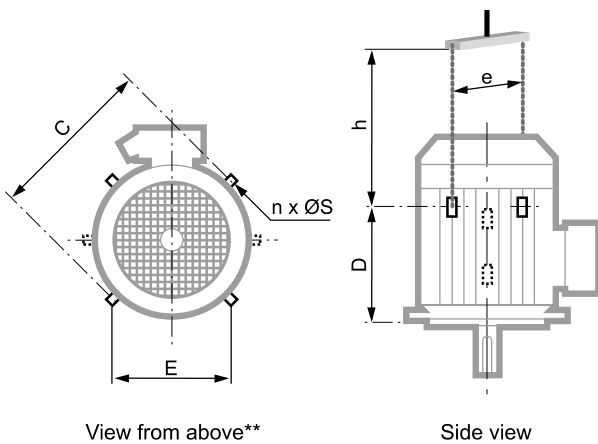

LS/LSES Series	Vertical position						
	C	E	D	n**	ØS	e mini*	h min
160 M/MU/L/LUR	320	200	230	2	14	320	350
180 MR	320	200	230	2	14	320	270
180 M/L/LUR	390	265	290	2	14	390	320
200 L/LR	410	300	295	2	14	410	450
200 LU	410	300	295	2	14	410	450
225 SR/MR	480	360	405	4	30	540	350
225 S/SG/M/MG	480	360	405	4	30	500	500
250 MZ	480	360	405	4	30	590	550
250 ME	480	360	405	4	30	500	500
280 SC/SD/MC/MD	480	360	405	4	30	500	500
315 SN	480	360	405	4	30	500	500
315 SP/MP/MR	630	-	570	2	30	630	550

* if the motor is fitted with a drip cover, allow an additional 50 to 100 mm to avoid damaging it when the load is swung.

** if n = 2, the lifting rings form a 90° angle with respect to the terminal box axis.

If n = 4, this angle becomes 45°.

Separate ring ≤ 25 kg
Built-in ring ≤ 25 kg

IMfinity® 3-phase induction motors - IE2 - IE3 - IE4 - Non IE Efficiency IP55 Cast Iron frame

Contents

GENERAL INFORMATION	100-101
Designation.....	100
Description.....	101
ELECTRICAL AND MECHANICAL DATA	102 to 112
IE2 powered by the mains.....	102-103
IE2 powered by the drive.....	104-105
IE3 powered by the mains.....	106-107
IE3 powered by the drive.....	108-109
IE4 powered by the mains.....	110
IE4 powered by the drive	111
Mains connection.....	112
DIMENSIONS.....	113 to 118
Shaft extensions	113
Foot mounted IM 1001 (IM B3).....	114
Foot and flange mounted IM 2001 (IM B35).....	115
Flange mounted IM 3001 (IM B5) IM 3011 (IM V1).....	116
Foot and face mounted IM 2101 (IM B34)	117
Face mounted IM 3601 (IM B14).....	118
CONSTRUCTION.....	119 to 130
Bearings and lubrication	119-120
Axial loads	121 to 123
Radial loads	124 to 130
OPTIONAL FEATURES	131 to 133
Non-standard flanges	131
Mechanical options.....	132
Mechanical and electrical options	133
INSTALLATION AND MAINTENANCE.....	134
Position of the lifting rings	134

IMfinity® 3-phase induction motors - IE2 - IE3 - IE4 - Non IE Efficiency

IP55 Cast Iron frame

General information

Designation



IP 55
Cl. F - ΔT 80 K

The complete motor **reference** described below will enable you to **order** the desired equipment.

The selection method consists of following the terms in the designation.

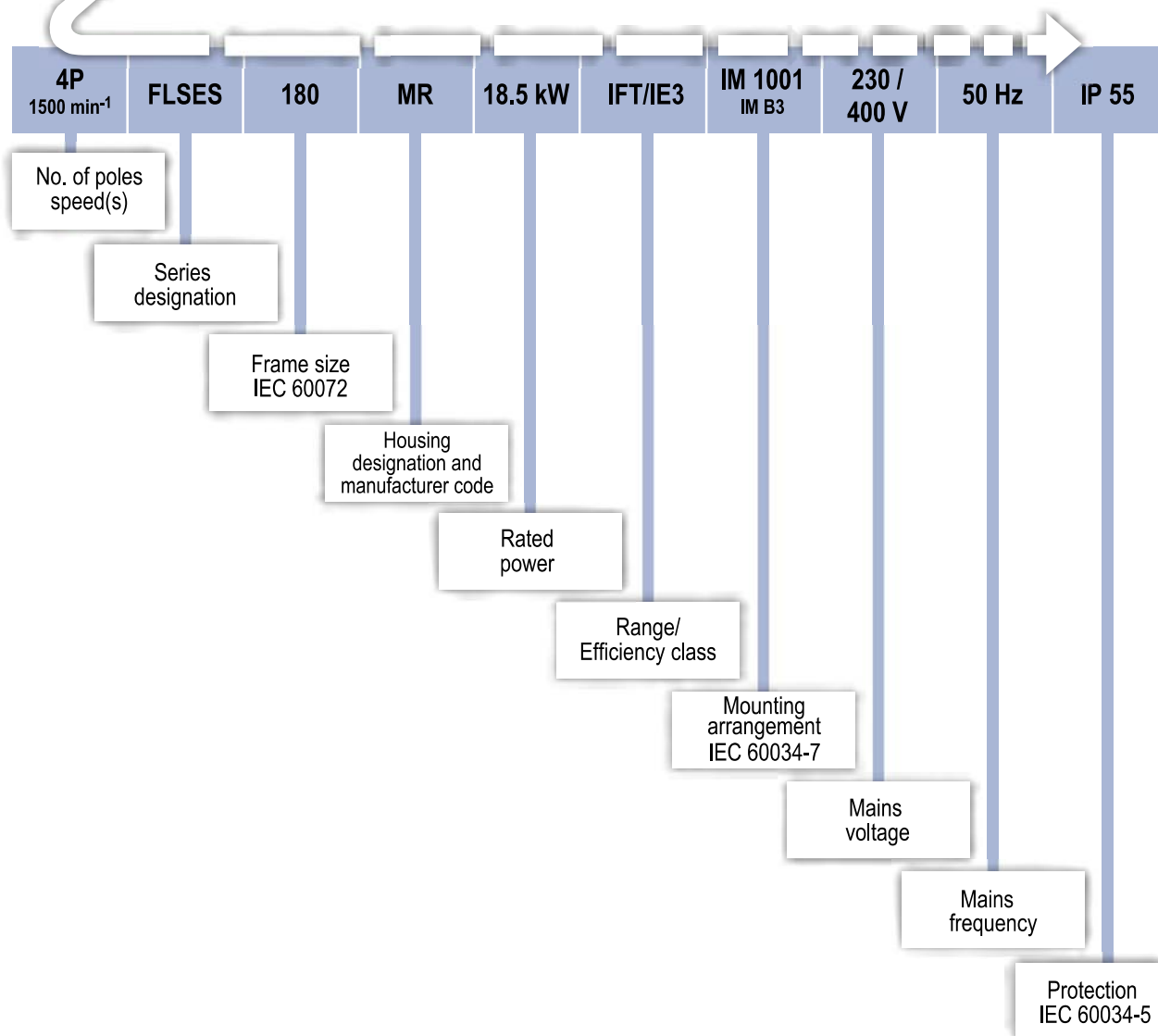

IMfinity® 3-phase induction motors - IE2 - IE3 - IE4 - Non IE Efficiency

IP55 Cast Iron frame

General information

Description

Component	Materials	Remarks
Housing with cooling fins	Cast iron	- lifting rings for frame size ≥ 90 - earth terminal with an optional jumper screw
Stator	Insulated low-carbon magnetic steel laminations Electroplated copper	- low carbon content guarantees long-term lamination pack stability - welded laminations - semi-enclosed slots - class F insulation
Rotor	Insulated low-carbon magnetic steel laminations Aluminium	- inclined cage bars - rotor cage pressure die-cast in aluminium (or alloy for special applications), or soldered in copper, or keyed for soldered rotors - shrink-fitted to shaft - rotor balanced dynamically, class A, 1/2 key
Shaft	Steel	- for frame size ≤ 132 : • closed keyway - for frame size ≤ 160 : • tapped hole - for frame size ≥ 160 : • open keyway
End shields	Cast iron	
Bearings and lubrication		- permanently greased bearings frame size 80 to 225 - regreasable bearings frame size 250 to 450 - bearings preloaded at NDE up to 315 S, preloaded at DE from size 315 M upwards
Labyrinth seal Lipseals	Plastic or steel Synthetic rubber	- labyrinth seal at drive end for foot mounted motors, frame size ≤ 132 - lipseal at drive end for foot and flange mounted or flange mounted motors, frame size ≤ 132 - lipseal at drive end and non drive end for frame sizes 160 to 250 inclusive - decompression grooves for 280 M to 355 LD - labyrinth seal at drive end and non drive end for frame sizes ≥ 355 LK
Fan	Composite up to size 280 inclusive Metal from 315 ST upwards	- 2 directions of rotation: straight blades
Fan cover	Pressed steel	- fitted, on request, with a drip cover for operation in vertical position, shaft end facing down
Terminal box	Cast iron body and cover for all frame sizes	- IP 55 - fitted with a block with 6 terminals up to 355 LD, 6 or 12 terminals for frame sizes 355LK/400/450 - terminal box fitted with threaded plugs up to 132 - from the 160 to the 355, undrilled cable gland mounting plate (nozzle and cable gland as options) - 1 earth terminal in each terminal box

In the standard version, the motors are wound 400 V 50 Hz:

- power ratings ≤ 5.5 kW: Y connection
- power ratings ≥ 7.5 kW: Δ connection

Other construction types

CORROBLOC FINISH

The CORROBLOC finish is a top coat for the basic cast iron motor described above. In addition to the basic construction, its special finishes resist corrosion in particularly harsh environments, and these qualities are enhanced with age.

Component	Materials	Remarks
Stator - Rotor		- dielectric and anti-corrosion protection for frame sizes 80 to 132
Nameplate	Stainless steel	- nameplate: indelible marking
Screws	Stainless steel	- captive screws for terminal box cover (frame size ≤ 132)
Terminal box	Cast iron body and cover	- terminal box with brass buttons for frame size ≤ 132
Cable gland	Brass	- option
External finish		- system IIIa (see External finish section) = C4M

IMfinity® 3-phase induction motors - IE2 - IE3 - IE4 - Non IE Efficiency

IP55 Cast Iron frame

Electrical and mechanical characteristics

IE2 powered by the mains

Type	Rated power P _n kW	380V 50Hz				415V 50Hz				460V 60Hz			
		Rated speed N _n min ⁻¹	Rated current I _n A	Efficiency η 4/4	Power factor Cos φ 4/4	Rated speed N _n min ⁻¹	Rated current I _n A	Efficiency η 4/4	Power factor Cos φ 4/4	Rated speed N _n min ⁻¹	Rated current I _n A	Efficiency η 4/4	Power factor Cos φ 4/4
2 poles													
FLSES 80 L	0.75	2815	1.65	78.6	0.88	2860	1.55	80.2	0.84	3470	1.4	81.7	0.83
FLSES 80 L	1.1	2820	2.4	79.6	0.87	2860	2.25	81.3	0.83	3475	2.05	83.0	0.82
FLSES 90 SL	1.5	2830	3.15	81.5	0.89	2875	2.9	83.8	0.86	3485	2.6	85.4	0.85
FLSES 90 L	2.2	2825	4.65	83.2	0.88	2870	4.3	84.1	0.84	3485	3.85	86.1	0.84
FLSES 100 L	3	2830	6.15	84.6	0.88	2875	5.85	85.8	0.83	3485	5.15	86.8	0.84
FLSES 112 MG	4	2910	7.85	87.8	0.88	2930	7.5	88.5	0.84	3535	6.6	89.6	0.85
FLSES 132 SM	5.5	2910	10.8	88.7	0.87	2930	9.95	90.2	0.85	3540	8.9	90.7	0.85
FLSES 132 SM	7.5	2900	14.7	88.1	0.88	2925	13.7	89.7	0.85	3535	12.1	90.5	0.86
FLSES 132 M	9	2915	17.4	89.6	0.88	2940	16.3	90.8	0.85	3540	14.5	91.9	0.85
FLSES 160 M	11	2940	21.1	90.0	0.88	2954	19.9	91.2	0.85	3554	17.7	91.3	0.85
FLSES 160 M	15	2930	28.1	90.3	0.90	2950	25.6	92.3	0.88	3554	22.7	92.8	0.89
FLSES 160 L	18.5	2935	34.7	90.9	0.90	2945	31.6	92.5	0.88	3550	28.1	93.0	0.89
FLSES 180 MR	22	2925	41	91.3	0.89	2945	37.7	92.3	0.88	3554	33.8	93.0	0.88
FLSES 200 LU	30	2945	56.2	92.0	0.88	2954	51.8	93.9	0.86	3554	46.2	94.0	0.87
FLSES 200 LU	37	2935	68.5	92.5	0.89	2950	62.9	94.2	0.87	3552	56.1	94.1	0.88
FLSES 225 MR	45	2940	83.4	93.0	0.88	2956	75.8	94.6	0.87	3558	67.9	94.6	0.88
FLSES 250 M	55	2966	99.7	93.7	0.89	2972	87.5	94.4	0.87	3574	83.2	94.3	0.88
FLSES 280 S	75	2962	133	93.8	0.91	2958	123	93.9	0.90	3566	111	93.6	0.91
FLSES 280 M	90	2961	160	94.1	0.91	2971	148	94.2	0.90	3567	131	94.5	0.91
FLSES 315 S	110	3574	197	94.3	0.90	2978	182	94.4	0.89	3576	164	94.5	0.89
FLSES 315 M	132	2974	236	94.6	0.90	2978	218	94.6	0.89	3576	196	95.0	0.89
FLSES 315 LA	160	2973	285	94.8	0.90	2977	264	94.9	0.89	3575	237	95.2	0.89
FLSES 315 LB	200	2973	355	95.0	0.90	2977	329	95.1	0.89	3575	296	95.4	0.89
FLSES 355 LA	250	2976	449	95.0	0.89	2982	416	95.1	0.88	3578	374	95.4	0.88
FLSES 355 LB	315	2981	566	95.0	0.89	2985	524	95.1	0.88	3583	471	95.4	0.88
FLSES 355 LC	355	2979	645	95.0	0.88	2983	597	95.1	0.87	3581	537	95.4	0.87
FLSES 355 LD	400	2987	710	95.0	0.90	2991	657	95.1	0.89	3589	591	95.4	0.89
FLSES 355 LKB	450	2988	809	95.0	0.89	2990	767	95.0	0.86	3590	673	95.4	0.88
FLSES 400 LB	560	2986	995	95.0	0.90	2989	943	95.0	0.87	3588	823	95.4	0.89
4 poles													
FLSES 80 LG	0.75	1435	1.75	80.3	0.82	1450	1.7	81.0	0.76	1756	1.5	83.5	0.75
FLSES 90 SL	1.1	1430	2.45	81.4	0.84	1445	2.35	82.2	0.79	1752	2.1	84.6	0.78
FLSES 90 L	1.5	1430	3.25	82.8	0.85	1445	3.1	83.4	0.80	1750	2.8	85.6	0.79
FLSES 100 L	2.2	1435	4.65	84.3	0.85	1450	4.45	85.4	0.80	1752	4	87.1	0.80
FLSES 100 LG	3	1440	6.2	85.5	0.86	1456	5.95	86.7	0.81	1756	5.4	87.5	0.80
FLSES 112 MU	4	1440	8.2	86.6	0.86	1454	7.65	88.1	0.83	1758	7.05	89.4	0.80
FLSES 132 SM	5.5	1450	11	87.9	0.86	1460	10.6	88.9	0.81	1764	9.45	90.3	0.81
FLSES 132 M	7.5	1445	14.8	88.7	0.87	1458	14.2	89.5	0.82	1762	12.5	90.9	0.83
FLSES 132 M	9	1450	17.8	89.0	0.86	1458	17.3	89.9	0.81	1764	15.2	91.3	0.82
FLSES 160 M	11	1464	21.4	90.5	0.86	1472	20.5	91.3	0.82	1772	18	92.2	0.83
FLSES 160 L	15	1458	29.1	90.6	0.87	1468	27.9	91.2	0.82	1770	24.5	92.4	0.83
FLSES 180 MT	18.5	1460	36	91.2	0.85	1468	34.5	91.3	0.82	1770	30.2	92.7	0.83
FLSES 180 L	22	1462	42.4	91.8	0.86	1470	40	92.5	0.83	1772	35.6	93.4	0.83
FLSES 200 LU	30	1456	58.2	92.3	0.85	1474	52.3	93.1	0.81	1780	48.8	93.8	0.82
FLSES 225 SR	37	1466	71.6	92.4	0.85	1474	64.1	93.4	0.81	1776	60.1	94.2	0.82
FLSES 225 M	45	1482	85.2	93.1	0.85	1486	80.5	94.9	0.82	1788	71.4	95.1	0.83
FLSES 250 MR	55	1480	107	93.5	0.84	1484	99.3	94.2	0.82	1784	88.3	95.3	0.82
FLSES 280 S	75	1482	143	94.0	0.85	1486	134	94.1	0.83	1784	119	94.5	0.84
FLSES 280 M	90	1481	169	94.2	0.86	1485	158	94.3	0.84	1785	141	94.5	0.85
FLSES 315 S	110	1483	208	94.5	0.85	1487	193	95.5	0.83	1786	173	95.0	0.84
FLSES 315 M	132	1484	246	94.7	0.86	1487	231	94.8	0.84	1787	205	95.0	0.85
FLSES 315 LA	160	1482	298	94.9	0.86	1486	279	95.0	0.84	1784	248	95.2	0.85
FLSES 315 LB	200	1483	372	95.1	0.86	1487	348	95.2	0.84	1784	310	95.4	0.85
FLSES 355 LA	250	1487	459	95.1	0.87	1490	430	95.2	0.85	1788	382	95.4	0.86
FLSES 355 LAL	280	1486	508	95.1	0.88	1489	476	95.2	0.86	1787	423	95.4	0.87
FLSES 355 LB	315	1485	572	95.1	0.88	1488	535	95.2	0.86	1787	476	95.4	0.87
FLSES 355 LC	355	1484	637	95.1	0.89	1488	596	95.2	0.87	1787	531	95.4	0.88
FLSES 355 LD	400	1486	743	95.1	0.86	1487	696	95.2	0.84	1788	619	95.4	0.85
FLSES 355 LKB	450	1490	827	95.1	0.87	1491	794	95.1	0.83	1792	694	95.8	0.85
FLSES 400 LB	500	1489	930	95.1	0.86	1490	862	95.1	0.83	1791	771	95.8	0.85
FLSES 450 LA	550	1491	988	95.1	0.89	1492	926	95.1	0.87	1793	819	95.8	0.88
FLSES 450 LB	675	1490	1241	95.1	0.87	1492	1163	95.1	0.85	1792	1028	95.8	0.86
FLSES 450 LD	800	1492	1437	95.1	0.89	1494	1378	95.1	0.85	1794	1205	95.8	0.87
FLSES 450 LD	900	1491	1636	95.1	0.88	1493	1551	95.1	0.85	1793	1355	95.8	0.87
6 poles													
FLSES 90 SL	0.75	940	2	77.1	0.74	954	1.95	78.1	0.68	-	-	-	-
FLSES 90 L	1.1	930	2.9	78.1	0.74	950	2.85	79.3	0.68	-	-	-	-
FLSES 100 LG	1.5	954	3.8	80.4	0.74	966	3.65	81.9	0.70	-	-	-	-
FLSES 112 MG	2.2	954	5.5	81.8	0.75	964	5.4	82.0	0.69	-	-	-	-
FLSES 132 SM	3	960	7.05	84.2	0.77	968	6.75	85.6	0.72	-	-	-	-
FLSES 132 M	4	954	9.15	84.6	0.79	966	8.8	85.9	0.74	-	-	-	-
FLSES 132 M	5.5	960	13	86.0	0.75	970	13	86.4	0.68	-	-	-	-
FLSES 160 M	7.5	970	16.7	87.3	0.78	978	16.9	87.4	0.71	-	-	-	-
FLSES 160 LUR	11	972	24	88.7	0.79	978	23.4	88.8	0.74	-	-	-	-
FLSES 180 L	15	968	31	89.7	0.82	976	29.6	90.2	0.78	-	-	-	-
FLSES 200 LU	18.5	974	38.5	90.4	0.81	980	37.6	90.8	0.75	-	-	-	-
FLSES 200 LU	22	966	44.8	90.8	0.82	976	42.2	91.3	0.80	-	-	-	-
FLSES 225 M	30	984	58	91.7	0.86	986	54.5	92.3	0.83	-	-	-	-
FLSES 250 M	37	984	70.5	92.3	0.87	986	66.9	92.8	0.83	-	-	-	-
FLSES 280 S	45	984	85	92.7	0.87	987	81	92.8	0.83	1186	71	93.6	0.85
FLSES 280 M	55	984	104	93.1	0.86	988	99	93.2	0.83	1186	87	93.6	0.85
FLSES 315 S	75	989	147	93.7	0.83	992	141	93.8	0.79	1191	124	94.1	0.81
FLSES 315 M	90	987	177	94.0	0.82	990	171	94.1	0.78	1189	150	94.1	0.80
FLSES 315 LA	110	987	214	94.3	0.83	991	203	94.4	0.80	1189	177	95.0	0.82
FLSES 315 LB	132	988	247	94.6	0.86	991	249	94.7	0.78	1190	218	95.0	0.80
FLSES 355 LA	160	991	302	94.8	0.85	994	283	94.9	0.83	1193	249	95.0	0.85
FLSES 355 LB	200	991	390	95.0	0.82	994	357	95.1	0.82	1193	315	95.0	0.84
FLSES 355 LC	250	991	488	95.0	0.82	994	463	95.1	0.79	1193	408	95.0	0.81
FLSES 355 LKA	315	991	607	95.0	0.83	994	576	95.1	0.80	1193	508	95.0	0.82
FLSES 355 LKB	355	990	676	95.0	0.84	993	641	95.1	0.81	1192	565	95.0	0.83
FLSES 355 LKC	400	989	753	95.0	0.85	992	706	95.0	0.83	1189	622	95.0	0.85
FLSES 450 LA	450	995	867	95.0	0.83								

IMfinity® 3-phase induction motors - IE2 - IE3 - IE4 - Non IE Efficiency

IP55 Cast Iron frame

Electrical and mechanical characteristics

IE2 powered by the drive

Type	400V 50Hz				% Rated torque M_n at					400V 87Hz Δ^1				Speed mechanical maximum ²
	Rated power	Rated speed	Rated current	Power factor	10Hz	17Hz	25Hz	50Hz	87Hz	Rated power	Rated speed	Rated current	Power factor	
	P_n kW	N_n min ⁻¹	I_n A	Cos ϕ 4/4						P_n kW	N_n min ⁻¹	I_n A	Cos ϕ 4/4	
2 poles														
FLSES 80 L	0.75	2775	1.8	0.86	90%	100%	100%	100%	57%	1.31	4995	3.13	0.86	13500
FLSES 80 L	1.1	2775	2.6	0.85	85%	100%	100%	100%	57%	1.91	4995	4.56	0.85	13500
FLSES 90 SL	1.5	2790	3.45	0.87	85%	100%	100%	100%	57%	2.61	5010	5.99	0.87	11700
FLSES 90 L	2.2	2775	5.1	0.86	85%	100%	100%	100%	57%	3.83	4995	8.85	0.86	11700
FLSES 100 L	3	2790	6.6	0.87	85%	100%	100%	100%	57%	5.22	5010	11.44	0.87	9900
FLSES 112 MU	4	2895	8.4	0.86	85%	100%	100%	100%	57%	6.96	5115	14.65	0.86	9900
FLSES 132 SM	5.5	2890	11.8	0.86	85%	100%	100%	100%	57%	9.57	5110	20.55	0.86	6700
FLSES 132 SM	7.5	2875	16.2	0.87	85%	95%	100%	100%	57%	13.05	5095	28.24	0.87	6700
FLSES 132 M	9	2900	19	0.86	85%	95%	100%	100%	57%	15.66	5120	33.06	0.86	6700
FLSES 160 M	11	2935	22.5	0.86	85%	95%	100%	100%	57%	19.14	5155	39.14	0.86	6030
FLSES 160 M	15	2925	30.1	0.89	85%	95%	100%	100%	57%	26.1	5145	52.36	0.89	6030
FLSES 160 L	18.5	2905	37.4	0.89	85%	95%	100%	100%	57%	32.19	5125	65.05	0.89	5670
FLSES 180 M	22	2905	42.7	0.88	81%	90%	95%	100%	54%	36.27	5125	74.34	0.88	5670
FLSES 200 LU	30	2935	59.7	0.87	85%	90%	100%	100%	-	-	-	-	-	4500
FLSES 200 LU	37	2920	74	0.88	80%	90%	100%	100%	-	-	-	-	-	4500
FLSES 225 MR	45	2930	88.6	0.86	80%	90%	100%	100%	-	-	-	-	-	4320
FLSES 250 M	55	2960	108	0.88	80%	90%	100%	100%	-	-	-	-	-	4050
FLSES 280 S	75	2964	135	0.91	79%	89%	100%	100%	-	-	-	-	-	3580
FLSES 280 M	90	2965	164	0.91	79%	89%	100%	100%	-	-	-	-	-	3580
FLSES 315 S	110	2976	202	0.90	79%	89%	100%	100%	-	-	-	-	-	3580
FLSES 315 M	132	2976	243	0.90	79%	89%	100%	100%	-	-	-	-	-	3580
FLSES 315 LA	160	2975	293	0.90	79%	89%	100%	100%	-	-	-	-	-	3580
FLSES 315 LB	200	2975	365	0.90	79%	89%	100%	100%	-	-	-	-	-	3580
FLSES 355 LA	250	2978	461	0.89	98%	100%	100%	100%	-	-	-	-	-	3580
FLSES 355 LB	315	2983	580	0.89	79%	89%	100%	100%	-	-	-	-	-	3600
FLSES 355 LC	355	2981	663	0.88	79%	89%	100%	100%	-	-	-	-	-	3580
FLSES 355 LD	400	2984	720	0.90	90%	95%	100%	100%	-	-	-	-	-	3600
FLSES 355 LKB	450	2989	837	0.89	80%	90%	100%	100%	-	-	-	-	-	3600
FLSES 400 LB	560	2987	1036	0.89	80%	90%	100%	100%	-	-	-	-	-	3600
4 poles														
FLSES 80 LG	0.75	1425	1.9	0.79	90%	100%	100%	100%	57%	1.31	2535	3.31	0.79	11700
FLSES 90 SL	1.1	1420	2.6	0.81	90%	100%	100%	100%	57%	1.91	2530	4.56	0.81	11700
FLSES 90 L	1.5	1415	3.5	0.82	90%	100%	100%	100%	57%	2.61	2525	6.17	0.82	9900
FLSES 100 L	2.2	1420	5.1	0.82	90%	100%	100%	100%	57%	3.83	2530	8.85	0.82	9900
FLSES 100 LG	3	1435	6.6	0.83	90%	100%	100%	100%	57%	5.22	2545	11.53	0.83	9900
FLSES 112 MU	4	1425	9	0.84	90%	100%	100%	100%	57%	6.96	2535	15.64	0.84	9900
FLSES 132 SM	5.5	1440	12	0.83	90%	90%	100%	100%	57%	9.57	2550	20.91	0.83	6700
FLSES 132 M	7.5	1435	16	0.85	90%	90%	100%	100%	57%	13.05	2545	27.88	0.85	6700
FLSES 132 M	9	1440	19.3	0.83	90%	90%	100%	100%	57%	15.66	2550	33.6	0.83	6700
FLSES 160 M	11	1456	23.1	0.84	85%	95%	100%	100%	57%	19.14	2566	40.21	0.84	6030
FLSES 160 L	15	1450	31.3	0.85	85%	95%	100%	100%	57%	26.1	2560	54.5	0.85	6030
FLSES 180 MT	18.5	1450	38.1	0.84	79%	89%	99%	100%	57%	31.73	2560	66.23	0.84	6030
FLSES 180 L	22	1452	46.2	0.84	80%	90%	100%	100%	57%	38.28	2562	80.42	0.84	6030
FLSES 200 LU	30	1458	63	0.83	85%	95%	100%	100%	57%	52.2	2568	109.54	0.83	4500
FLSES 225 SR	37	1458	77.5	0.83	85%	95%	100%	100%	57%	64.38	2568	134.92	0.83	4320
FLSES 225 M	45	1478	92.9	0.84	85%	95%	100%	100%	57%	78.3	2588	161.73	0.84	4050
FLSES 250 MR	55	1476	114	0.83	85%	95%	100%	100%	57%	95.7	2586	198.36	0.83	4050
FLSES 280 S	75	1485	148	0.84	79%	89%	100%	100%	56%	-	-	-	-	2610
FLSES 280 M	90	1485	177	0.84	79%	89%	100%	100%	57%	-	-	-	-	2610
FLSES 315 S	110	1486	210	0.86	90%	100%	100%	100%	57%	-	-	-	-	2610
FLSES 315 M	132	1487	250	0.87	96%	100%	100%	100%	57%	-	-	-	-	2610
FLSES 315 LA	160	1484	303	0.87	95%	99%	100%	100%	57%	-	-	-	-	2610
FLSES 315 LB	200	1486	374	0.87	94%	98%	100%	100%	55%	-	-	-	-	2610
FLSES 355 LA	250	1488	465	0.87	98%	100%	100%	100%	57%	-	-	-	-	2610
FLSES 355 LAL	280	1487	507	0.87	96%	99%	100%	100%	58%	-	-	-	-	2610
FLSES 355 LB	315	1488	594	0.87	79%	89%	100%	100%	57%	-	-	-	-	2610
FLSES 355 LC	355	1487	670	0.87	78%	89%	100%	100%	57%	-	-	-	-	2610
FLSES 355 LD	400	1491	720	0.89	85%	87%	100%	100%	57%	400	2610	740	0.89	2610
FLSES 355 LKB	450	1491	858	0.86	80%	90%	100%	100%	-	-	-	-	-	1800
FLSES 400 LB	500	1490	943	0.87	80%	90%	100%	100%	-	-	-	-	-	1800
FLSES 450 LA	550	1492	1011	0.89	80%	90%	100%	100%	-	-	-	-	-	1800
FLSES 450 LB	675	1491	1268	0.87	80%	90%	100%	100%	-	-	-	-	-	1800
FLSES 450 LD	800	1493	1478	0.88	80%	90%	100%	100%	-	-	-	-	-	1800
FLSES 450 LD	900	1492	1666	0.88	80%	90%	100%	100%	-	-	-	-	-	1800
6 poles														
FLSES 90 SL	0.75	925	2.1	0.70	100%	100%	100%	100%	57%	1.31	1665	3.66	0.70	11700
FLSES 90 L	1.1	915	3.1	0.71	100%	100%	100%	100%	57%	1.91	1655	5.36	0.71	11700
FLSES 100 LG	1.5	945	4.15	0.71	100%	100%	100%	100%	57%	2.61	1685	7.24	0.71	9900
FLSES 112 M	2.2	940	5.9	0.72	100%	100%	100%	100%	57%	3.83	1680	10.28	0.72	9900
FLSES 132 SM	3	952	7.5	0.74	100%	100%	100%	100%	57%	5.22	1692	13.13	0.74	6700
FLSES 132 M	4	945	9.8	0.77	100%	100%	100%	100%	57%	6.96	1685	17.07	0.77	6700
FLSES 132 M	5.5	952	13.8	0.73	100%	100%	100%	100%	57%	9.57	1692	23.95	0.73	6700
FLSES 160 M	7.5	966	17.8	0.74	100%	100%	100%	100%	57%	13.05	1706	30.92	0.84	6030
FLSES 160 LUR	11	966	25.5	0.76	95%	100%	100%	100%	57%	19.14	1706	44.32	0.84	6030
FLSES 180 L	15	964	33.5	0.80	80%	90%	100%	100%	57%	26.1	1704	58.26	0.84	6030
FLSES 200 LU	18.5	968	40.9	0.78	80%	90%	100%	100%	57%	32.19	1708	71.12	0.84	4500
FLSES 200 LU	22	958	49.1	0.81	80%	90%	100%	100%	57%	38.28	1698	85.42	0.84	4500
FLSES 225 MG	30	980	61.7	0.84	90%	100%	100%	100%	57%	52.20	1720	107.4	0.84	4050
FLSES 250 M	37	982	75.4	0.85	90%	100%	100%	100%	57%	64.38	1722	131.17	0.85	4050
FLSES 280 S	45	986	89	0.9	79%	89%	100%	100%	57%	-	-	-	-	1740
FLSES 280 M	55	986	108	0.9	79%	89%	100%	100%	57%	-	-	-	-	1740
FLSES 315 S	75	990	155	0.8	79%	89%	100%	100%	54%	-	-	-	-	1740
FLSES 315 M	90	991	187	0.8	79%	89%	100%	100%	57%	-	-	-	-	1740
FLSES 315 LA	110	991	228	0.8	79%	89%	100%	100%	57%	-	-	-	-	1740

IMfinity® 3-phase induction motors - IE2 - IE3 - IE4 - Non IE Efficiency

IP55 Cast Iron frame

Electrical and mechanical characteristics

IE2 powered by the drive

Summary of recommended protection devices

Mains voltage	Cable length	Frame size	Winding protection	Insulated bearings
≤ 480 V	< 20 m	All frame sizes	Standard	No
		≤ 315	Standard	No
	> 20 m and < 100 m	≥ 315	RIS or drive filter	NDE
> 480 V and ≤ 690 V	< 20 m	< 250	Standard	No
		≥ 250	RIS or drive filter	NDE
	> 20 m and < 100 m	≤ 250	RIS or drive filter	NDE
		≥ 250	RIS or drive filter	NDE
		≥ 250	RIS or drive filter	NDE (or DE+NDE if no filter for ≥ 315)

RIS: Reinforced Insulation System.

The filter is recommended above frame size 315.

Standard insulation = 1500 V peak and 3500 V/μs.

Protection solutions exist (insulation for winding and bearings).

For different cable length(s) and/or voltage(s), please consult Leroy-Somer.

Motors of frame size ≥ 280 with RIS option are no longer cURus.



REMINDER: All 2, 4 and 6 pole motors placed on the EU market must be IE3 or IE2 and used with a variable speed drive:

- from 01/01/2015 for power ratings from 7.5 to 375 kW
- from 01/01/2017 for power ratings from 0.75 to 375 kW

Other drive mechanism solutions:



LSRPM / PLSRPM: permanent magnet synchronous motors 3 to 500 kW

Variable speed application, requiring IP55 or IP23 protection, high efficiency and/or compact dimensions.



CPLS: induction motors 95 to 2900 Nm

Application for variable speed operation requiring constant power over a wide speed range



LSMV: induction motors 0.18 to 132 kW

Application for variable speed operation requiring constant torque over a wide speed range.



LSK: D.C. motors 2 to 750 kW



UNIMOTOR FM and HD: servomotors 0.7 to 136 Nm

IMfinity® 3-phase induction motors - IE2 - IE3 - IE4 - Non IE Efficiency

IP55 Cast Iron frame

Electrical and mechanical characteristics

IE3 powered by the mains

Type	Rated power P _n kW	Rated torque M _n N.m	Starting torque/ Rated torque M _d /M _n	Maximum torque/ Rated torque M _m /M _n	Starting current/ Rated current I _d /I _n	Moment of inertia J kg.m ²	Weight IM B3 kg	Noise LP db(A)	400V 50Hz							
									Rated speed N _n min ⁻¹	Rated current I _n A	Efficiency IEC 60034-2-1 2007			Power factor		
											4/4	3/4	2/4	4/4	3/4	2/4
2 poles																
FLSES 80 L	0.75	2.5	2.8	3.6	7.0	0.00095	16.2	59	2885	1.6	81.7	81.8	79.6	0.83	0.76	0.62
FLSES 80 LG	1.1	3.65	2.4	3.2	6.6	0.00201	22.5	59	2885	2.25	83.7	84.5	83.7	0.85	0.79	0.68
FLSES 90 SL	1.5	4.95	2.9	3.0	7.0	0.00223	24	68	2890	3	85.0	86.0	85.3	0.85	0.79	0.68
FLSES 90 LU	2.2	7.25	3.4	3.2	8.1	0.00292	28.2	70	2895	4.3	86.3	87.5	87.4	0.86	0.80	0.70
FLSES 100 L	3	9.9	3.2	3.6	8.1	0.00364	35.2	66	2895	5.75	87.3	88.3	88.0	0.86	0.81	0.70
FLSES 112 MG	4	13.1	2.1	3.0	7.2	0.00941	44.8	66	2920	7.5	88.5	89.2	88.6	0.87	0.82	0.72
FLSES 132 SM	5.5	17.9	2.0	2.8	6.5	0.00974	69.3	67	2935	10.2	89.6	90.4	90.0	0.87	0.83	0.74
FLSES 132 SM	7.5	24.4	2.1	2.9	6.9	0.01102	74.6	67	2940	13.9	90.7	91.5	91.3	0.86	0.82	0.73
FLSES 132 M	9	29.2	2.5	3.2	7.6	0.01203	78.2	67	2940	16.8	91.3	92.0	91.7	0.85	0.80	0.72
FLSES 160 M	11	35.5	3.4	3.1	8.5	0.0712	120	68	2956	19.3	92.2	92.6	92.1	0.89	0.86	0.79
FLSES 160 M	15	48.6	2.9	2.9	7.3	0.0551	133	68	2950	26.7	92.4	93.1	93.1	0.88	0.85	0.79
FLSES 160 LUR	18.5	59.9	2.9	2.8	7.4	0.0626	135	69	2950	32.9	92.5	93.2	93.2	0.88	0.86	0.79
FLSES 180 MUR	22	71.2	3.0	3.4	8.1	0.1012	195	74	2952	38	93.6	94.1	93.8	0.89	0.87	0.81
FLSES 200 LU	30	97.1	2.1	3.1	7.3	0.1186	210	71	2950	53.1	93.9	94.3	94.0	0.87	0.84	0.77
FLSES 200 LU	37	120	2.1	3.4	7.0	0.1388	230	75	2945	64.5	94.0	94.6	94.5	0.88	0.86	0.80
FLSES 225 MR	45	146	2.3	3.1	7.5	0.1597	254	71	2950	78.2	94.2	94.8	94.8	0.88	0.86	0.80
FLSES 250 M	55	177	2.1	3.2	7.7	0.3356	378	78	2968	95.3	94.5	94.6	93.7	0.88	0.85	0.79
FLSES 280 S	75	241	2.1	2.7	7.0	0.48	565	79	2966	126	94.9	95.3	95.2	0.91	0.89	0.85
FLSES 280 M	90	290	2.2	2.8	7.4	0.57	615	80	2967	151	95.3	95.7	95.5	0.90	0.89	0.85
FLSES 315 S	110	353	2.1	2.6	6.7	1.17	940	82	2975	185	95.7	95.5	94.6	0.90	0.89	0.84
FLSES 315 M	132	424	2.1	2.5	6.7	1.25	1015	82	2975	221	96.0	96.1	95.6	0.90	0.89	0.84
FLSES 315 LA	160	514	2.0	2.9	7.7	1.34	1088	82	2975	270	96.0	96.1	95.6	0.89	0.87	0.83
FLSES 315 LB	200	643	2.1	2.5	6.9	1.45	1150	82	2973	334	96.3	96.5	96.0	0.90	0.88	0.84
FLSES 355 LA	250	802	2.9	2.9	6.8	3.02	1590	83	2978	428	96.0	96.0	95.3	0.88	0.86	0.80
FLSES 355 LB	315	1008	2.8	3.6	7.7	3.62	1740	84	2983	537	96.2	96.2	95.6	0.88	0.86	0.81
FLSES 355 LC	355	1137	2.5	3.2	7.3	3.64	1740	84	2981	612	96.3	96.0	95.1	0.87	0.84	0.78
FLSES 355 LD	400	1282	2.0	2.9	7.2	3.7	1770	84	2989	670	97.0	97.1	96.9	0.89	0.88	0.85
FLSES 355 LKB*	450	1438	2.3	4.35	11.5	8.95	2550	94	2989	774	95.3	94.7	93.4	0.88	0.85	0.78
FLSES 400 LB	560	1790	1.94	3.70	9.6	8.95	2560	94	2987	959	95.8	95.2	94.0	0.88	0.85	0.78
<i>* IE2 motors</i>																
4 poles																
FLSES 80 LG	0.75	4.95	2.2	3.1	6.6	0.00335	22	57	1450	1.65	83.2	84.0	82.9	0.80	0.72	0.59
FLSES 90 SL	1.1	7.25	2.4	3.2	7.5	0.00418	24.6	48	1450	2.3	84.8	85.7	84.9	0.81	0.74	0.61
FLSES 90 LU	1.5	9.85	2.8	3.6	7.5	0.00524	28.2	51	1454	3.2	85.6	86.0	84.5	0.79	0.71	0.57
FLSES 100 LR	2.2	14.5	3.5	3.9	8.3	0.00676	36.4	49	1452	4.6	86.9	87.4	86.3	0.79	0.71	0.57
FLSES 100 LG	3	19.6	2.5	3.3	7.2	0.01152	42.2	50	1460	6.05	88.3	89.1	88.6	0.81	0.74	0.61
FLSES 112 MU	4	26.2	2.7	3.1	7.1	0.01429	48.9	50	1458	8.1	88.8	89.6	89.2	0.80	0.73	0.62
FLSES 132 SM	5.5	35.9	2.9	3.7	8.4	0.02286	70.9	60	1462	10.5	90.1	90.7	90.2	0.84	0.78	0.67
FLSES 132 MR	7.5	49.1	2.8	3.4	8.5	0.03313	89.4	61	1460	13.8	90.6	91.5	91.3	0.86	0.81	0.71
FLSES 160 M	9	58.5	2.4	3.1	8.3	0.0601	105	59	1468	16.7	91.3	92.0	91.7	0.85	0.80	0.70
FLSES 160 M	11	71.7	2.3	2.9	7.6	0.0712	115	59	1466	20.1	91.7	92.7	92.8	0.86	0.82	0.73
FLSES 160 LUR	15	97.4	2.3	3.2	8.0	0.0954	140	58	1470	27.5	92.3	93.0	92.9	0.85	0.81	0.72
FLSES 180 M	18.5	120	3.1	3.4	8.1	0.1333	165	67	1470	34.1	92.8	93.5	93.4	0.84	0.80	0.71
FLSES 180 LUR	22	143	3.3	3.3	7.9	0.1555	190	68	1470	41.2	93.2	93.8	93.6	0.83	0.79	0.69
FLSES 200 LU	30	194	3.1	2.9	7.3	0.2035	250	64	1474	54.9	93.9	94.4	94.2	0.84	0.80	0.70
FLSES 225 S	37	238	2.0	2.7	6.8	0.5753	355	65	1484	67.5	94.0	94.4	94.1	0.84	0.80	0.71
FLSES 225 M	45	290	2.1	2.7	6.8	0.6482	390	64	1484	82.9	94.7	95.1	95.0	0.83	0.79	0.70
FLSES 250 MR	55	354	2.1	2.5	6.9	0.7701	440	67	1482	101	94.8	95.2	95.1	0.83	0.79	0.70
FLSES 280 S	75	482	2.5	2.7	7.8	0.85	595	74	1484	137	95.0	95.1	94.4	0.84	0.80	0.71
FLSES 280 M	90	579	2.4	2.7	7.8	0.98	645	74	1483	162	95.2	95.4	95.0	0.84	0.82	0.72
FLSES 315 S	110	707	2.7	2.4	6.6	1.84	930	74	1486	199	95.4	95.4	94.9	0.84	0.81	0.72
FLSES 315 M	132	848	2.8	2.8	6.8	2.09	985	74	1487	234	95.9	95.9	95.6	0.85	0.82	0.76
FLSES 315 LA	160	1030	2.8	2.4	6.6	2.35	1045	74	1484	283	96.0	96.2	96.0	0.85	0.82	0.75
FLSES 315 LB	200	1285	2.7	2.9	7.2	2.86	1245	74	1486	354	96.0	96.2	96.0	0.85	0.82	0.73
FLSES 355 LA	250	1604	2.6	3.1	7.5	4.9	1445	80	1488	436	96.3	96.3	94.7	0.86	0.82	0.71
FLSES 355 LAL	280	1798	2.3	2.9	7.4	5.8	1560	80	1487	483	96.2	96.4	95.9	0.87	0.84	0.77
FLSES 355 LB	315	2020	2.5	3.8	7.8	6.56	1720	80	1488	543	96.3	96.5	96.0	0.87	0.83	0.75
FLSES 355 LC	355	2280	2.1	3.4	6.7	6.56	1720	80	1487	607	96.0	96.2	95.7	0.88	0.84	0.76
FLSES 355 LD	400	2577	1.9	2.3	5.8	6.6	1750	80	1488	707	96.4	96.7	96.6	0.85	0.82	0.75
FLSES 355 LKB	450	2882	1.77	2.69	6.9	13.75	2350	84	1491	794	96.2	96.3	94.6	0.85	0.83	0.75
FLSES 400 LB	500	3205	1.59	2.42	6.2	13.75	2400	84	1490	873	96.1	96.2	94.9	0.86	0.84	0.76
FLSES 450 LA	550	3520	1.48	2.19	6.7	23.70	3100	84	1492	936	96.4	96.6	96.2	0.88	0.87	0.82
FLSES 450 LB	675	4323	1.67	2.74	6.9	26.55	3775	84	1491	1174	96.5	96.6	96.4	0.86	0.85	0.80
FLSES 450 LD	800	5117	2.10	2.90	8.5	34.80	4400	84	1493	1368	97.0	96.8	96.4	0.87	0.85	0.77
FLSES 450 LD	900	5761	1.90	2.60	7.6	34.80	4400	84	1492	1543	96.8	96.6	96.4	0.87	0.85	0.77
6 poles																
FLSES 90 SL	0.75	7.55	1.9	2.3	4.5	0.00378	24.2	40	950	1.9	79.1	80.1	78.3	0.72	0.63	0.50
FLSES 90 LU	1.1	11	2.3	2.6	4.8	0.00519	29.3	57	954	2.75	81.7	82.3	80.4	0.71	0.62	0.48
FLSES 100 LG	1.5	14.8	2.4	2.8	5.7	0.01523	41.3	47	966	3.6	83.5	84.1	82.6	0.72	0.64	0.50
FLSES 112 MU	2.2	21.7	2.3	2.8	5.6	0.01899	49	45	968	5.35	84.5	85.1	83.6	0.70	0.62	0.49
FLSES 132 SM	3	29.5	2.7	3.1	6.4	0.02528	65	50	972	6.85	86.5	86.9	85.6	0.73	0.66	0.53
FLSES 132 M	4	39.4	2.4	2.9	6.3	0.03027	72.7	54	970	9.15	87.3	87.9	86.7	0.72	0.65	0.53
FLSES 132 MU	5.5	54.4	2.7	2.8	6.3	0.03699	87	55	966	11.9	88.2	89.3	89.0	0.76	0.70	0.58
FLSES 160 MU	7.5	73.2	2.0	3.1	6.5	0.1295	117	57	978	17.4	89.5	89.6	88.3	0.77	0.70	0.57
FLSES 180 L	11	107	3.0	3.8	8.2	0.2048	170	61	982	22.6	91.0	91.2	90.3	0.77	0.70	0.58
FLSES 180 LUR	15	146	3.3	2.8	7.5	0.253	202	60	978	31.9	91.3	91.6	90.9	0.74	0.68	0.56
FLSES 200 LU	18.5	181	2.5	3.0	7.0	0.2588	210	60	978	36.6	91.9	92.6	92.4	0.79	0.74	

IMfinity® 3-phase induction motors - IE2 - IE3 - IE4 - Non IE Efficiency

IP55 Cast Iron frame

Electrical and mechanical characteristics

IE3 powered by the mains

Type	Rated power P _n kW	380V 50Hz				415V 50Hz				460V 60Hz			
		Rated speed N _n min ⁻¹	Rated current I _n A	Efficiency η 4/4	Power factor Cos φ 4/4	Rated speed N _n min ⁻¹	Rated current I _n A	Efficiency η 4/4	Power factor Cos φ 4/4	Rated speed N _n min ⁻¹	Rated current I _n A	Efficiency η 4/4	Power factor Cos φ 4/4
2 poles													
FLSES 80 L	0.75	2870	1.65	81.4	0.85	2895	1.6	82.1	0.80	3505	1.4	82.7	0.80
FLSES 80 LG	1.1	2865	2.35	82.7	0.87	2890	2.2	84.1	0.83	3500	1.95	84.8	0.83
FLSES 90 SL	1.5	2870	3.1	84.2	0.87	2900	2.95	85.2	0.83	3505	2.65	86.0	0.83
FLSES 90 LU	2.2	2875	4.45	85.9	0.88	2905	4.15	86.9	0.84	3510	3.7	87.6	0.85
FLSES 100 L	3	2870	5.95	87.1	0.88	2900	5.6	87.5	0.85	3515	5.05	88.3	0.85
FLSES 112 MG	4	2910	7.75	88.1	0.89	2935	7.35	88.9	0.86	3540	6.6	89.2	0.86
FLSES 132 SM	5.5	2925	10.6	89.2	0.88	2940	9.85	90.1	0.85	3545	8.9	90.8	0.86
FLSES 132 SM	7.5	2930	14.6	90.1	0.87	2945	13.6	91.0	0.85	3550	12.3	90.6	0.85
FLSES 132 M	9	2935	17.3	91.1	0.87	2950	16.5	91.4	0.83	3554	14.6	92.3	0.84
FLSES 160 M	11	2950	20.2	91.8	0.90	2960	18.8	92.5	0.88	3562	17	92.4	0.88
FLSES 160 M	15	2940	27.8	92.0	0.89	2956	25.7	92.7	0.87	3556	23	93.2	0.88
FLSES 160 LUR	18.5	2935	34.1	92.4	0.89	2952	31.8	92.7	0.87	3558	28.4	93.2	0.87
FLSES 180 MUR	22	2945	40	93.0	0.90	2958	37.1	93.8	0.88	3560	33.1	93.8	0.88
FLSES 200 LU	30	2945	55.3	93.5	0.88	2954	51.7	94.0	0.86	3554	46.4	94.0	0.87
FLSES 200 LU	37	2935	67.6	93.7	0.89	2950	62.8	94.3	0.87	3552	56.3	94.2	0.88
FLSES 225 MR	45	2940	81.7	94.0	0.89	2956	75.7	94.6	0.87	3558	68.1	94.6	0.88
FLSES 250 M	55	2966	99.1	94.3	0.89	2972	87.2	94.6	0.87	3574	83.3	94.3	0.88
FLSES 280 S	75	2962	132	94.7	0.91	2968	122	95.2	0.90	3566	110	94.1	0.91
FLSES 280 M	90	2961	158	95.0	0.91	2971	146	95.5	0.90	3567	132	95.0	0.90
FLSES 315 S	110	2972	195	95.2	0.90	2977	178	95.5	0.90	3575	161	95.0	0.90
FLSES 315 M	132	2971	233	95.7	0.90	2976	213	96.0	0.90	3575	193	95.4	0.90
FLSES 315 LA	160	2971	281	96.0	0.90	2976	260	96.2	0.89	3575	233	95.8	0.90
FLSES 315 LB	200	2969	351	96.3	0.90	2974	324	96.6	0.89	3575	291	95.8	0.90
FLSES 355 LA	250	2976	445	95.9	0.89	2982	411	96.2	0.88	3578	372	95.8	0.88
FLSES 355 LB	315	2979	562	95.8	0.89	2985	524	96.2	0.87	3583	469	95.8	0.88
FLSES 355 LC	355	2977	640	95.8	0.88	2983	596	96.3	0.86	3581	535	95.8	0.87
FLSES 355 LD	400	2987	694	97.0	0.90	2991	647	96.8	0.89	3589	585	96.5	0.89
FLSES 355 LKB	450	2988	806	95.3	0.89	2990	765	95.2	0.86	3590	673	95.3	0.88
FLSES 400 LB	560	2986	987	95.8	0.90	2989	936	95.7	0.87	3588	823	95.9	0.89
4 poles													
FLSES 80 LG	0.75	1450	1.65	82.6	0.83	1454	1.6	83.4	0.78	1758	1.45	85.4	0.76
FLSES 90 SL	1.1	1450	2.35	84.1	0.84	1454	2.3	84.9	0.79	1758	2.05	86.4	0.78
FLSES 90 LU	1.5	1454	3.25	85.3	0.82	1458	3.15	85.9	0.77	1762	2.8	87.3	0.77
FLSES 100 LR	2.2	1452	4.7	86.7	0.81	1456	4.65	87.1	0.76	1762	4.1	88.3	0.76
FLSES 100 LG	3	1460	6.2	87.7	0.84	1462	6.05	88.4	0.78	1766	5.35	90.0	0.79
FLSES 112 MU	4	1458	8.3	88.6	0.83	1462	8.05	88.9	0.78	1764	7.45	85.5	0.79
FLSES 132 SM	5.5	1462	10.9	89.6	0.86	1466	10.3	90.2	0.82	1768	9.25	91.2	0.82
FLSES 132 MR	7.5	1460	14.5	90.4	0.87	1464	13.5	91.0	0.85	1768	12.2	91.7	0.85
FLSES 160 M	9	1468	17.3	90.9	0.87	1472	16.4	91.7	0.83	1772	14.6	92.4	0.84
FLSES 160 M	11	1466	21	91.4	0.87	1468	19.5	92.2	0.85	1772	17.5	92.9	0.85
FLSES 160 LUR	15	1470	28.7	92.1	0.87	1474	26.9	92.6	0.84	1774	24.1	93.3	0.84
FLSES 180 M	18.5	1470	35.6	92.6	0.86	1472	33.5	93.0	0.83	1774	29.9	93.6	0.83
FLSES 180 LUR	22	1470	42.4	93.0	0.85	1474	40.1	93.4	0.82	1776	36.3	93.8	0.81
FLSES 200 LU	30	1474	56.8	93.6	0.85	1476	53.7	94.2	0.82	1780	48.3	94.5	0.83
FLSES 225 S	37	1484	70.4	93.9	0.85	1486	65.8	94.5	0.83	1786	59.4	94.5	0.83
FLSES 225 M	45	1484	85.9	94.3	0.84	1486	80.7	95.0	0.82	1788	72.2	95.1	0.82
FLSES 250 MR	55	1482	105	94.6	0.84	1484	98.4	95.0	0.82	1784	88.3	95.3	0.82
FLSES 280 S	75	1483	142	94.7	0.85	1486	133	94.8	0.83	1784	117	95.4	0.84
FLSES 280 M	90	1481	168	95.0	0.86	1485	159	95.1	0.83	1783	141	95.4	0.84
FLSES 315 S	110	1486	204	95.4	0.86	1487	194	95.4	0.83	1786	172	95.8	0.84
FLSES 315 M	132	1484	241	95.6	0.87	1487	229	95.8	0.84	1787	203	96.0	0.85
FLSES 315 LA	160	1482	292	95.8	0.87	1486	276	96.1	0.84	1784	249	96.2	0.85
FLSES 315 LB	200	1483	364	96.0	0.87	1487	345	96.0	0.84	1786	307	96.2	0.85
FLSES 355 LA	250	1487	450	96.0	0.88	1490	425	96.2	0.85	1788	379	96.2	0.86
FLSES 355 LAL	280	1487	503	96.0	0.88	1488	471	96.1	0.86	1787	420	96.2	0.87
FLSES 355 LB	315	1488	567	96.0	0.88	1489	530	96.3	0.86	1787	472	96.2	0.87
FLSES 355 LC	355	1487	631	96.0	0.89	1488	592	96.0	0.87	1786	532	96.2	0.87
FLSES 355 LD	400	1488	736	96.3	0.86	1489	690	96.6	0.84	1790	607	96.2	0.86
FLSES 355 LKB	450	1490	817	96.2	0.87	1491	784	96.2	0.83	1792	689	96.4	0.85
FLSES 400 LB	500	1489	919	96.1	0.86	1490	871	96.2	0.83	1791	766	96.4	0.85
FLSES 450 LA	550	1491	974	96.4	0.89	1492	912	96.4	0.87	1793	812	96.6	0.88
FLSES 450 LB	675	1490	1222	96.5	0.87	1492	1145	96.5	0.85	1792	1019	96.7	0.86
FLSES 450 LD	800	1492	1408	97.0	0.89	1494	1350	97.0	0.85	1794	1189	97.1	0.87
FLSES 450 LD	900	1491	1605	96.8	0.88	1493	1522	96.8	0.85	1793	1340	96.9	0.87
6 poles													
FLSES 90 SL	0.75	945	1.9	78.9	0.75	956	1.9	79.5	0.70	-	-	-	-
FLSES 90 LU	1.1	945	2.8	81.0	0.74	958	2.75	81.8	0.68	-	-	-	-
FLSES 100 LG	1.5	962	3.65	83.0	0.75	970	3.55	83.8	0.70	-	-	-	-
FLSES 112 MU	2.2	962	5.4	84.3	0.73	972	5.35	84.7	0.68	-	-	-	-
FLSES 132 SM	3	970	7	85.6	0.76	974	6.85	86.0	0.71	-	-	-	-
FLSES 132 M	4	966	9.3	86.8	0.75	972	9.15	87.9	0.69	-	-	-	-
FLSES 132 MU	5.5	962	12.1	88.0	0.78	970	11.7	88.5	0.74	-	-	-	-
FLSES 160 MU	7.5	974	18.1	89.1	0.79	980	17.1	89.6	0.74	-	-	-	-
FLSES 180 L	11	978	23.2	90.6	0.79	984	22.3	91.2	0.75	-	-	-	-
FLSES 180 LUR	15	976	32.7	91.2	0.76	982	31.7	91.4	0.72	-	-	-	-
FLSES 200 LU	18.5	974	37.8	91.7	0.81	980	36	92.1	0.78	-	-	-	-
FLSES 200 LU	22	978	43.8	92.2	0.79	984	40.5	92.7	0.77	-	-	-	-
FLSES 225 M	30	984	57.3	92.9	0.86	986	53.9	93.3	0.83	-	-	-	-
FLSES 250 M	37	984	70.5	93.4	0.85	986	67	93.7	0.82	-	-	-	-
FLSES 280 S	45	984	84	93.7	0.87	987	80	94.2	0.84	1186	71	94.5	0.85
FLSES 280 M	55	985	103	94.1	0.86	988	99	94.4	0.82	1186	87	94.5	0.84
FLSES 315 S	75	989	146	95.0	0.83	992	139	95.1	0.79	1190	122	95.0	0.81
FLSES 315 M	90	987	172	94.9	0.84	992	166	95.2	0.79	1191	145	95.0	0.82
FLSES 315 LA	110	987	209	95.1	0.84	992	203	95.4	0.79	1191	176	95.8	0.82
FLSES 315 LB	132	988	256	95.4	0.82	991	243	95.7	0.79	1190	217	95.8	0.80
FLSES 355 LA	160	992	295	95.8	0.86	994	276	96.0	0.84	1193	247	95.8	0.85
FLSES 355 LB	200	991	374	95.8	0.85	994	350	95.9	0.83	1193	312	95.8	0.84
FLSES 355 LC	250	991	484	95.8	0.82	994	454	95.9	0.80	1193	405	95.8	0.81
FLSES 355 LKA	315	991	602	95.8	0.83	994	565	95.8	0.81	1193	504	95.8	0.82
FLSES 355 LKB	355	990	671	95.8	0.84	993	629	95.8	0.82	1192	561	95.8	0.83
FLSES 355 LKC	400	989	746	95.9	0.85	992	697	96.3	0.83	1189	615	96.1	0.85
FLSES 450 LA	450	995	856										

IMfinity® 3-phase induction motors - IE2 - IE3 - IE4 - Non IE Efficiency

IP55 Cast Iron frame

Electrical and mechanical characteristics

IE3 powered by the drive

Type	400V 50Hz				% Rated torque M_n at					400V 87Hz Δ^1				Maximum mechanical speed ²
	Rated power	Rated speed	Rated current	Power factor	10Hz	17Hz	25Hz	50Hz	87Hz	Rated power	Rated speed	Rated current	Power factor	
	P_n kW	N_n min ⁻¹	I_n A	Cos ϕ 4/4						P_n kW	N_n min ⁻¹	I_n A	Cos ϕ 4/4	
2 poles														
FLSES 80 L	0.75	2845	1.75	0.83	90%	100%	100%	100%	57%	1.31	5065	3.04	0.83	13500
FLSES 80 LG	1.1	2845	2.46	0.85	85%	100%	100%	100%	57%	1.91	5065	4.29	0.85	13500
FLSES 90 SL	1.5	2850	3.4	0.85	85%	100%	100%	100%	57%	2.61	5070	5.9	0.85	11700
FLSES 90 LU	2.2	2850	4.72	0.86	85%	100%	100%	100%	57%	3.83	5070	8.22	0.86	11700
FLSES 100 L	3	2855	6.45	0.86	85%	100%	100%	100%	57%	5.22	5075	11.26	0.86	9900
FLSES 112 MG	4	2900	8.5	0.87	85%	100%	100%	100%	57%	6.96	5120	14.74	0.87	9900
FLSES 132 SM	5.5	2910	11.6	0.87	85%	100%	100%	100%	57%	9.57	5130	20.19	0.87	6700
FLSES 132 SM	7.5	2915	15.5	0.86	85%	95%	100%	100%	57%	13.05	5135	26.98	0.86	6700
FLSES 132 M	9	2935	17.9	0.87	85%	95%	100%	100%	57%	15.70	5155	31.20	0.87	6700
FLSES 160 M	11	2945	21.9	0.89	85%	95%	100%	100%	57%	19.14	5165	38.24	0.89	6030
FLSES 160 M	15	2935	30.1	0.88	85%	95%	100%	100%	57%	26.10	5155	52.36	0.88	6030
FLSES 160 LUR	18.5	2925	37.4	0.88	85%	95%	100%	100%	-	-	-	-	-	4500
FLSES 180 MUR	22	2935	43.5	0.89	85%	95%	100%	100%	-	-	-	-	-	5670
FLSES 200 LU	30	2935	59.6	0.87	85%	90%	100%	100%	-	-	-	-	-	4500
FLSES 200 LU	37	2920	73.9	0.88	80%	90%	100%	100%	-	-	-	-	-	4700
FLSES 225 MR	45	2930	88.6	0.88	80%	90%	100%	100%	-	-	-	-	-	4320
FLSES 250 M	55	2960	107.8	0.88	80%	90%	100%	100%	-	-	-	-	-	4050
FLSES 280 S	75	2960	135	0.91	75%	85%	100%	100%	-	-	-	-	-	3580
FLSES 280 M	90	2961	164	0.91	75%	85%	100%	100%	-	-	-	-	-	3580
FLSES 315 S	110	2972	202	0.90	75%	85%	100%	100%	-	-	-	-	-	3580
FLSES 315 M	132	2972	243	0.90	75%	85%	100%	100%	-	-	-	-	-	3580
FLSES 315 LA	160	2971	293	0.90	75%	85%	100%	100%	-	-	-	-	-	3600
FLSES 315 LB	200	2971	365	0.90	75%	85%	100%	100%	-	-	-	-	-	3580
FLSES 355 LA	250	2976	461	0.89	73%	96%	100%	100%	-	-	-	-	-	3580
FLSES 355 LB	315	2979	580	0.89	75%	85%	100%	100%	-	-	-	-	-	3600
FLSES 355 LC	355	2977	663	0.88	75%	85%	100%	100%	-	-	-	-	-	3580
FLSES 355 LD	400	2984	718	0.90	90%	95%	100%	100%	-	-	-	-	-	3600
FLSES 355 LKB	450	2989	837	0.89	80%	90%	100%	100%	-	-	-	-	-	3600
FLSES 400 LB	560	2987	1036	0.89	80%	90%	100%	100%	-	-	-	-	-	3600
4 poles														
FLSES 80 LG	0.75	1435	1.8	0.80	90%	100%	100%	100%	57%	1.31	2545	3.13	0.80	13500
FLSES 90 SL	1.1	1430	2.6	0.81	90%	100%	100%	100%	57%	1.91	2540	4.47	0.81	11700
FLSES 90 LU	1.5	1435	3.5	0.79	90%	100%	100%	100%	57%	2.61	2545	6.08	0.79	11700
FLSES 100 LR	2.2	1440	5	0.79	90%	100%	100%	100%	57%	3.83	2550	8.76	0.79	9900
FLSES 100 LG	3	1445	6.7	0.81	90%	100%	100%	100%	57%	5.22	2555	11.71	0.81	9900
FLSES 112 MU	4	1440	8.8	0.80	90%	100%	100%	100%	57%	6.96	2550	15.37	0.80	9900
FLSES 132 SM	5.5	1450	11.6	0.84	90%	90%	100%	100%	57%	9.57	2560	20.19	0.84	6700
FLSES 132 MR	7.5	1445	15.7	0.86	90%	90%	100%	100%	57%	13.05	2555	27.34	0.86	6700
FLSES 160 M	9	1462	17.9	0.87	85%	95%	100%	100%	57%	15.70	2572	31.20	0.87	6030
FLSES 160 M	11	1454	22.7	0.86	85%	95%	100%	100%	57%	19.14	2564	39.49	0.86	6030
FLSES 160 LUR	15	1458	30.7	0.85	85%	95%	100%	100%	57%	26.10	2568	53.43	0.85	5670
FLSES 180 M	18.5	1458	38.3	0.84	80%	90%	100%	100%	57%	32.19	2568	66.66	0.84	5670
FLSES 180 LUR	22	1460	46	0.83	80%	90%	100%	100%	57%	38.28	2570	80.06	0.83	4500
FLSES 200 LU	30	1466	61.7	0.84	85%	95%	100%	100%	57%	52.20	2576	107.4	0.84	4500
FLSES 225 S	37	1476	76.1	0.84	85%	95%	100%	100%	57%	64.38	2586	132.42	0.84	4320
FLSES 225 M	45	1478	92.9	0.83	85%	95%	100%	100%	57%	78.30	2588	161.73	0.83	4320
FLSES 250 MR	55	1476	114	0.83	85%	95%	100%	100%	57%	95.70	2586	198.36	0.83	4050
FLSES 280 S	75	1485	148	0.84	75%	85%	100%	100%	56%	-	-	-	-	2610
FLSES 280 M	90	1485	177	0.84	75%	85%	100%	100%	57%	-	-	-	-	2610
FLSES 315 S	110	1486	210	0.86	90%	100%	100%	100%	57%	-	-	-	-	2610
FLSES 315 M	132	1487	250	0.87	96%	97%	100%	100%	57%	-	-	-	-	2610
FLSES 315 LA	160	1484	303	0.87	91%	94%	100%	100%	57%	-	-	-	-	2610
FLSES 315 LB	200	1486	374	0.87	89%	93%	100%	100%	55%	-	-	-	-	2610
FLSES 355 LA	250	1488	465	0.87	93%	95%	100%	100%	57%	-	-	-	-	2610
FLSES 355 LAL	280	1487	507	0.87	92%	95%	100%	100%	58%	-	-	-	-	2610
FLSES 355 LB	315	1488	594	0.87	75%	85%	100%	100%	57%	-	-	-	-	2610
FLSES 355 LC	355	1487	670	0.87	75%	85%	100%	100%	57%	-	-	-	-	2610
FLSES 355 LD	400	1491	718	0.89	85%	87%	100%	100%	57%	400	2610	736	0.90	2610
FLSES 355 LKB	450	1491	858	0.86	80%	90%	100%	100%	-	-	-	-	-	1800
FLSES 400 LB	500	1490	943	0.87	80%	90%	100%	100%	-	-	-	-	-	1800
FLSES 450 LA	550	1492	1011	0.89	80%	90%	100%	100%	-	-	-	-	-	1800
FLSES 450 LB	675	1491	1268	0.87	80%	90%	100%	100%	-	-	-	-	-	1800
FLSES 450 LD	800	1493	1478	0.88	80%	90%	100%	100%	-	-	-	-	-	1800
FLSES 450 LD	900	1492	1666	0.88	80%	90%	100%	100%	-	-	-	-	-	1800
6 poles														
FLSES 90 SL	0.75	930	2.05	0.72	100%	100%	100%	100%	57%	1.31	1670	3.57	0.72	11700
FLSES 90 LU	1.1	935	3.9	0.71	100%	100%	100%	100%	57%	1.91	1675	5.09	0.71	11700
FLSES 100 LG	1.5	954	3.9	0.72	100%	100%	100%	100%	57%	2.61	1694	6.79	0.72	9900
FLSES 112 MU	2.2	954	5.75	0.70	100%	100%	100%	100%	57%	3.83	1694	10.01	0.70	9900
FLSES 132 SM	3	962	7.3	0.73	100%	100%	100%	100%	57%	5.22	1702	12.69	0.73	6700
FLSES 132 M	4	960	9.9	0.72	100%	100%	100%	100%	57%	6.96	1700	17.24	0.72	6700
FLSES 132 MU	5.5	954	13.05	0.76	100%	100%	100%	100%	57%	9.57	1694	22.7	0.76	6700
FLSES 160 MU	7.5	970	17.35	0.77	100%	100%	100%	100%	57%	13.05	1710	30.2	0.77	6030
FLSES 180 L	11	976	24.65	0.77	95%	100%	100%	100%	57%	19.14	1716	42.89	0.77	5670
FLSES 180 LUR	15	972	35.2	0.74	80%	90%	100%	100%	57%	26.1	1712	61.3	0.74	4500
FLSES 200 LU	18.5	970	40.5	0.79	80%	90%	100%	100%	57%	32.19	1710	70.59	0.79	4500
FLSES 200 LU	22	976	48.7	0.77	80%	90%	100%	100%	57%	38.28	1716	84.71	0.77	4500
FLSES 225 M	30	980	61.7	0.84	90%	100%	100%	100%	57%	52.2	1720	107.4	0.84	4050
FLSES 250 M	37	982	75.4	0.84	90%	100%	100%	100%	57%	64.38	1722	131.17	0.84	4050
FLSES 280 S	45	986	89	0.85	75%	85%	100%	100%	57%	-	-	-	-	1740
FLSES 280 M	55	986	108	0.9	75%	85%	100%	100%	57%	-	-	-	-	1740
FLSES 315 S	75	990	155	0.8	75%	85%	100%	100%	54%	-	-	-	-	1740
FLSES 315 M	90	991	187	0.8	75%	85%	100%	100%	57%	-	-	-	-	1740
FLSES 315 LA	110	991	228	0.8	75%	85%	100%	100%	57%	-	-	-	-	1740
FLSES 315 LB	132</													

IMfinity® 3-phase induction motors - IE2 - IE3 - IE4 - Non IE Efficiency

IP55 Cast Iron frame

Electrical and mechanical characteristics

IE3 powered by the drive

Summary of recommended protection devices

Mains voltage	Cable length	Frame size	Winding protection	Insulated bearings
≤ 480 V	< 20 m	All frame sizes	Standard	No
		≤ 315	Standard	No
	> 20 m and < 100 m	≥ 315	RIS or drive filter	NDE
> 480 V and ≤ 690 V	< 20 m	< 250	Standard	No
		≥ 250	RIS or drive filter	NDE
	> 20 m and < 100 m	≤ 250	RIS or drive filter	NDE
		≥ 250	RIS or drive filter	NDE
		≥ 250	RIS or drive filter	NDE (or DE+NDE if no filter for ≥ 315)

RIS: Reinforced Insulation System.

The filter is recommended above frame size 315.

Standard insulation = 1500 V peak and 3500 V/μs.

Protection solutions exist (insulation for winding and bearings).

For different cable length(s) and/or voltage(s), please consult Leroy-Somer.



REMINDER: All 2, 4 and 6 pole motors placed on the EU market must be IE3 or IE2 and used with a variable speed drive:

- from 01/01/2015 for power ratings from 7.5 to 375 kW
- from 01/01/2017 for power ratings from 0.75 to 375 kW

Other drive mechanism solutions:



LSRPM / PLSRPM: permanent magnet synchronous motors 3 to 500 kW

Variable speed application, requiring IP55 or IP23 protection, high efficiency and/or compact dimensions.



CPLS: induction motors 95 to 2900 Nm

Application for variable speed operation requiring constant power over a wide speed range.



LSMV: induction motors 0.18 to 132 kW

Application for variable speed operation requiring constant torque over a wide speed range.



LSK: D.C. motors 2 to 750 kW



UNIMOTOR FM and HD: servomotors 0.7 to 136 Nm

IMfinity® 3-phase induction motors - IE2 - IE3 - IE4 - Non IE Efficiency

IP55 Cast Iron frame

Electrical and mechanical characteristics

IE4 powered by the mains

Type	Rated power P _n kW	Rated torque M _n N.m	Starting torque/ Rated torque M _d /M _n	Maximum torque/ Rated torque M _m /M _n	Starting intensity/ Rated intensity I _d /I _n	Moment of inertia J kg.m ²	Weight IM B3 kg	Noise (50Hz) LP db(A)	400V 50Hz							
									Rated speed N _n min ⁻¹	Rated current I _n A	Efficiency IEC 60034-2-1 2007 η			Power factor Cos φ		
											4/4	3/4	2/4	4/4	3/4	2/4
2 poles																
FLSES 280 M	75	241	2.6	3.4	8.9	0.57	615	80	2977	126	95.6	95.9	95.8	0.90	0.89	0.85
FLSES 315 S	90	288	2.5	3.1	8.1	1.17	940	80	2982	150	96.0	96.0	95.5	0.90	0.89	0.85
FLSES 315 M	110	352	2.5	3.0	8.0	1.25	1015	80	2984	186	96.1	96.2	95.7	0.89	0.88	0.83
FLSES 315 LA	132	423	2.5	3.4	8.0	1.34	1070	80	2983	222	96.5	96.6	96.2	0.89	0.88	0.83
FLSES 315 LA	160	514	2.1	2.8	6.7	1.34	1070	80	2972	266	96.4	96.5	96.1	0.90	0.89	0.84
FLSES 315 LB	200	642	2.1	2.9	6.9	1.45	1150	80	2973	332	96.5	96.7	96.5	0.90	0.88	0.84
FLSES 355 LB	250	799	3.2	3.8	9.7	3.62	1650	83	2988	434	96.6	96.6	96.4	0.86	0.84	0.89
FLSES 355 LB	315	1009	2.6	3.0	7.9	3.62	1650	83	2982	534	96.8	96.8	96.6	0.88	0.86	0.81
FLSES 355 LC	355	1137	2.8	2.7	7.2	3.64	1660	83	2981	610	96.6	96.7	96.5	0.87	0.86	0.80
4 poles																
FLSES 315 S	75	481	2.7	4.5	9.6	1.84	940	67	1490	137	96.2	96.3	95.8	0.82	0.79	0.70
FLSES 315 S	90	577	2.5	4.1	8.4	1.84	940	67	1490	163	96.1	96.2	95.7	0.83	0.81	0.70
FLSES 315 M	110	706	3.3	3.3	8.0	2.09	980	70	1488	199	96.3	96.3	96.0	0.83	0.81	0.74
FLSES 315 LA	132	848	2.8	3.1	7.8	2.35	1055	70	1487	230	96.4	96.7	96.5	0.86	0.84	0.77
FLSES 315 LB	160	1028	3.4	3.8	8.8	2.86	1245	70	1487	288	96.7	96.9	96.5	0.83	0.79	0.71
FLSES 355 LAL	200	1281	3.3	4.1	9.8	5.80	1560	74	1491	364	96.7	97.0	96.8	0.82	0.80	0.71
FLSES 355 LB	250	1602	3.0	3.7	9.4	6.56	1650	74	1490	439	96.7	96.9	96.6	0.85	0.82	0.75
FLSES 355 LB	280	1793	2.8	4.3	8.7	6.56	1720	80	1491	492	96.7	96.5	96.0	0.85	0.82	0.66
FLSES 355 LC	315	2022	2.7	3.1	8.4	6.60	1700	74	1488	540	96.7	97.0	96.9	0.87	0.85	0.79
FLSES 355 LD	355	2271	1.9	3.2	8.8	6.60	1765	75	1493	594	96.9	97.1	95.5	0.89	0.86	0.80

Type	Rated power P _n kW	380V 50Hz				415V 50Hz				460V 60Hz			
		Rated speed	Rated current	Efficiency	Power factor	Rated speed	Rated current	Efficiency	Power factor	Rated speed	Rated current	Efficiency	Power factor
		N _n min ⁻¹	I _n A	η 4/4	Cos φ 4/4	N _n min ⁻¹	I _n A	η 4/4	Cos φ 4/4	N _n min ⁻¹	I _n A	η 4/4	Cos φ 4/4
2 poles													
FLSES 280 M	75	2967	131	95.6	0.91	2976	122	95.6	0.895	1572	110	95.4	0.90
FLSES 315 S	90	2977	159	95.8	0.90	2981	147	96.0	0.89	3584	133	95.4	0.89
FLSES 315 M	110	2975	193	96.0	0.90	2979	179	96.0	0.89	3583	162	95.6	0.89
FLSES 315 LA	132	2975	232	96.2	0.90	2979	214	96.4	0.89	3583	194	95.8	0.89
FLSES 315 LA	160	2970	284	96.3	0.89	2975	260	96.3	0.89	3581	233	95.8	0.90
FLSES 315 LB	200	2969	350	96.5	0.90	2974	324	96.6	0.89	3580	293	96.2	0.89
FLSES 355 LB	250	2984	452	96.6	0.87	2989	424	96.6	0.85	3586	378	96.4	0.86
FLSES 355 LB	315	2978	564	96.5	0.88	2984	521	96.7	0.87	3582	467	96.2	0.88
FLSES 355 LC	355	2977	635	96.5	0.88	2982	586	96.8	0.87	3582	532	96.2	0.87
4 poles													
FLSES 315 S	75	1487	143	96.1	0.83	1491	134	96.3	0.81	1792	121	96.2	0.81
FLSES 315 S	90	1488	169	96.1	0.84	1491	161	96.2	0.81	1791	145	96.2	0.81
FLSES 315 M	110	1487	205	96.0	0.85	1490	194	96.1	0.82	1791	173	96.2	0.83
FLSES 315 LA	132	1485	239	96.4	0.87	1488	224	96.5	0.85	1788	202	96.5	0.85
FLSES 315 LB	160	1486	300	96.6	0.84	1488	281	96.6	0.82	1787	251	96.5	0.83
FLSES 355 LAL	200	1488	374	96.7	0.84	1490	355	96.7	0.81	1791	317	96.6	0.82
FLSES 355 LB	250	1488	454	96.7	0.865	1491	428	96.8	0.84	1791	381	96.8	0.85
FLSES 355 LB	280	1488	512	96.7	0.86	1489	479	96.8	0.84	1789	427	96.8	0.85
FLSES 355 LC	315	1489	562	96.7	0.88	1489	526	96.8	0.86	1788	469	96.8	0.87
FLSES 355 LD	355	1490	634	96.7	0.88	1494	580	96.8	0.88	1793	523	96.8	0.88

IMfinity® 3-phase induction motors - IE2 - IE3 - IE4 - Non IE Efficiency

IP55 Cast Iron frame

Electrical and mechanical characteristics

IE4 powered by the drive

Type	400V 50Hz				% Rated torque M _n at					Speed mechanical maximum
	Rated power	Rated speed	Rated current	Power factor	10Hz	17Hz	25Hz	50Hz	60Hz	
	P _n kW	N _n min ⁻¹	I _n A	Cos φ 4/4						
2 poles										
FLSES 280 M	75	2977	137	0.91	241	241	241	241	200	3600
FLSES 315 S	90	2982	166	0.90	288	288	288	288	226	3600
FLSES 315 M	110	2984	212	0.90	352	352	352	352	292	3600
FLSES 315 LA	132	2983	240	0.90	423	423	423	423	350	3600
FLSES 315 LA	160	2972	293	0.89	467	490	514	514	424	3600
FLSES 315 LB	200	2973	365	0.90	575	600	642	642	530	3600
FLSES 355 LB	250	2988	460	0.87	799	799	799	799	665	3600
FLSES 355 LB	315	2982	580	0.88	850	930	1009	1009	840	3600
FLSES 355 LC	355	2981	630	0.88	1000	1070	1137	1137	950	3600
4 poles										
FLSES 315 S	75	1490	142	0.83	450	465	481	481	401	2610
FLSES 315 S	90	1488	173	0.84	577	577	577	577	481	2610
FLSES 315 M	110	1487	212	0.85	706	706	706	706	588	2610
FLSES 315 LA	132	1487	260	0.87	840	870	884	884	737	2610
FLSES 315 LB	160	1487	316	0.84	900	950	1028	1028	857	2610
FLSES 355 LAL	200	1491	381	0.84	1281	1281	1281	1281	1068	2610
FLSES 355 LB	250	1490	460	0.87	1500	1602	1602	1602	1335	2610
FLSES 355 LB	280	1491	531	0.86	1650	1703	1793	1793	1040	2610
FLSES 355 LC	315	1488	570	0.88	1620	1825	2022	2022	1685	2610
FLSES 355 LD	355	1493	635	0.88	2000	2100	2271	2271	1893	2610

Summary of recommended protection devices

Mains voltage	Cable length	Frame size	Winding protection	Insulated bearings
≤ 480 V	< 20 m	All frame sizes	Standard	No
	> 20 m and < 100 m	≤ 315	Standard	No
		≥ 315	RIS or drive filter	NDE
> 480 V and ≤ 690 V	< 20 m	< 250	Standard	No
		≥ 250	RIS or drive filter	NDE
	> 20 m and < 100 m	≤ 250	RIS or drive filter	NDE
		≥ 250	RIS or drive filter	NDE (or DE+NDE if no filter for ≥ 315)

RIS: Reinforced Insulation System.

The filter is recommended above frame size 315.

Standard insulation = 1500 V peak and 3500 V/μs.

Protection solutions exist (insulation for winding and bearings).

For different cable length(s) and/or voltage(s), please consult Leroy-Somer.

IMfinity® 3-phase induction motors - IE2 - IE3 - IE4 - Non IE Efficiency

IP55 Cast Iron frame

Electrical and mechanical characteristics

Mains connection

DESCRIPTIVE TABLE OF TERMINAL BOXES FOR 400 V RATED SUPPLY VOLTAGE (in accordance with EN 50262)

Series	Type	No. of poles	Terminal box material	Power + auxiliaries	
				Number of drill holes	Drill hole diameter*
FLSES	80	2 ; 4	Cast iron	1 (2 if auxiliaries)	ISO M20 X 1.5
	90	2; 4; 6			
	100	2; 4; 6			
	112	2; 4; 6		2	ISO M25 X 1.5
	132	2; 4; 6			
	160	2; 4; 6			
	180	2; 4; 6		0	Removable undrilled mounting plate (see details page 164)
	200	2; 4; 6			
	225	2; 4; 6			
	250	2; 4; 6			
	280	2; 4; 6			
	315	2; 4; 6			
	355/400/450	2; 4; 6			

*As an option, both ISO M25 cable glands may be replaced by 1 ISO x M25 and 1 ISO x M32 (to comply with standard DIN 42925).

TERMINAL BLOCKS DIRECTION OF ROTATION

Standard motors are fitted with a block of 6 terminals complying with standard NFC 51 120, with the terminal markings complying with IEC 60034-8 (or NF EN 60034-8).

When the motor is running in U1, V1, W1 or 1U, 1V, 1W from a direct mains supply L1, L2, L3, it turns clockwise when seen from the drive shaft end.

If any two of the phases are changed over, the motor will run in an anticlockwise direction (make sure that the motor has been designed to run in both directions). If the motor is fitted with accessories (thermal protection or space heater), these must be connected on screw dominos with labelled wires.

Tightening torque for the nuts on the terminal blocks

Terminal	M5	M6	M8	M10	M12	M14	M16
Torque N.m	2.5	4	10	20	35	50	65

Series	Type	230/400V connections		400/690V connections
		No. of poles	Terminals	Terminals
FLSES	80 to 112	2; 4; 6	M5	M5
	132 S to 160	2; 4; 6	M6	M6
	180 L	6	M6	M6
	180 M	4	M8	M6
	180 LUR	6	M6	M6
	180 MUR	2; 4	M8	M6
	200 LU	2 (30 kW) ; 4 ; 6	M8	M8
		2 (37 kW)	M10	M8
	225 M	4	M10	M8
		6	M8	
	225 to 250	2	M10	M8
		4		M10
	250 M	6	M8	M8
	280 to 315	2; 4; 6	M12	M12
	355 L	2; 4; 6	M12	M12
	355 LK	4 ; 6	M14	M14
	355 LKB	2	M14	M14
		4		
	355 LKC	6	M14	M14
	400 LB	2 ; 4	M14	M14
	450 LA	4 ; 6	M14	M14
	450 LB	4 ; 6	M14	M14
	450 LC	6	M14	M14
450 LD	4	M14	M14	

IMfinity® 3-phase induction motors - IE2 - IE3 - IE4 - Non IE Efficiency

IP55 Cast Iron frame

Dimensions

Shaft extensions

Dimensions in millimetres

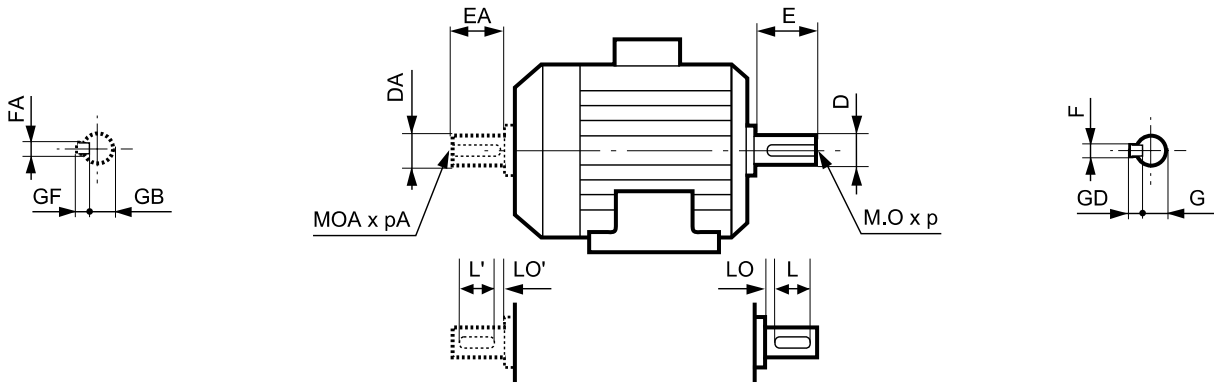

Type	Main shaft extensions																		
	4 and 6 poles										2 poles								
	F	GD	D	G	E	O	p	L	LO		F	GD	D	G	E	O	p	L	LO
FLSES 80 L/LG/LU	6	6	19j6	15.5	40	6	16	30	6		6	6	19j6	15.5	40	6	16	30	6
FLSES 90 S/L/LU	8	7	24j6	20	50	8	19	40	6		8	7	24j6	20	50	8	19	40	6
FLSES 90 SL	8	7	24j6	20	50	8	19	40	6		8	7	24j6	20	50	8	19	40	6
FLSES 100 L	8	7	28j6	24	60	10	22	50	6		8	7	28j6	24	60	10	22	50	6
FLSES 100 LG	8	7	28j6	24	60	10	22	50	6		8	7	28j6	24	60	10	22	50	6
FLSES 100 LR	8	7	28j6	24	60	10	22	50	6		8	7	28j6	24	60	10	22	50	6
FLSES 112 M/MG/MU	8	7	28j6	24	60	10	22	50	6		8	7	28j6	24	60	10	22	50	6
FLSES 132 S/M/MR/MU	10	8	38k6	33	80	12	28	63	10		10	8	38k6	33	80	12	28	63	10
FLSES 132 SM	10	8	38k6	33	80	12	28	63	10		10	8	38k6	33	80	12	28	63	10
FLSES 160 M/L/LU	12	8	42k6	37	110	16	36	100	6		12	8	42k6	37	110	16	36	90	6
FLSES 160 MU	12	8	42k6	37	110	16	36	90	20		12	8	42k6	37	110	16	36	90	20
FLSES 160 LUR	12	8	42k6	37	110	16	36	90	20		12	8	42k6	37	110	16	36	90	20
FLSES 180 MT	14	9	48k6	42.5	110	16	36	90	20		14	9	48k6	42.5	110	16	36	90	20
FLSES 180 MUR	14	9	48k6	42.5	110	16	36	90	20		14	9	48k6	42.5	110	16	36	98	12
FLSES 180 M/MR/L/LUR	14	9	48k6	42.5	110	16	36	98	12		14	9	48k6	42.5	110	16	36	98	12
FLSES 200 LU	16	10	55m6	49	110	20	42	90	20		16	10	55m6	49	110	20	42	90	20
FLSES 225 SR/M/MR/S	18	11	60m6	53	140	20	42	125	15		16	10	55m6	49	110	20	42	90	20
FLSES 225 SG	18	11	60m6	53	140	20	42	125	15		16	10	55m6	49	110	20	42	125	15
FLSES 250 M	18	11	65m6	58	140	20	42	125	15		18	11	60m6	53	140	20	42	125	15
FLSES 250 MR	18	11	65m6	58	140	20	42	125	15		18	11	65m6	58	140	20	42	125	15
FLSES 280 S/M	20	12	75m6	67.5	140	20	42	125	15		18	11	65m6	58	140	20	42	125	15
FLSES 315 S/M	22	14	80m6	71	170	20	42	140	30		18	11	65m6	58	140	20	42	125	15
FLSES 315 LA/LB	25	14	90m6	81	170	24	50	140	30		20	12	70m6	62.5	140	20	42	125	15
FLSES 355 LA/LB/LC/LD	28	16	100m6	90	210	24	50	180	30		22	14	80m6	71	170	20	42	140	30
FLSES 355 LAL	28	16	100m6	90	210	24	50	180	30		-	-	-	-	-	-	-	-	-
FLSES 355 LKB	28	16	100m6	90	210	24	50	180	30		22	14	80m6	71	170	20	42	140	30
FLSES 355 LKC	28	16	100m6	90	210	24	50	180	30		-	-	-	-	-	-	-	-	-
FLSES 400 LB	28	16	110m6	100	210	24	50	180	30		22	14	80m6	71	170	20	42	140	30
FLSES 450 LA	32	18	120m6	109	210	24	50	180	30		-	-	-	-	-	-	-	-	-
FLSES 450 LB	32	18	120m6	109	210	24	50	180	30		-	-	-	-	-	-	-	-	-
FLSES 450 LC	32	18	120m6	109	210	24	50	180	30		-	-	-	-	-	-	-	-	-
FLSES 450 LD	32	18	120m6	109	210	24	50	180	30		-	-	-	-	-	-	-	-	-

Type	Secondary shaft extensions																		
	4 and 6 poles										2 poles								
	FA	GF	DA	GB	EA	OA	pA	L'	LO'		FA	GF	DA	GB	EA	OA	pA	L'	LO'
FLSES 80 L/LG/LU	5	5	14j6	11	30	5	15	25	3.5		5	5	14j6	11	30	5	15	25	3.5
FLSES 90 S/L/LU	6	6	19j6	15.5	40	6	16	30	6		6	6	19j6	15.5	40	6	16	30	6
FLSES 90 SL	6	6	19j6	15.5	40	6	16	30	6		6	6	19j6	15.5	40	6	16	30	6
FLSES 100 L	8	7	24j6	20	50	8	19	40	6		8	7	24j6	20	50	8	19	40	6
FLSES 100 LG	8	7	24j6	20	50	8	19	40	6		8	7	24j6	20	50	8	19	40	6
FLSES 100 LR	8	7	24j6	20	50	8	19	40	6		8	7	24j6	20	50	8	19	40	6
FLSES 112 M/MG/MU	8	7	24j6	20	50	8	19	40	6		8	7	24j6	20	50	8	19	40	6
FLSES 132 S/M/MR/MU	8	7	28k6	24	60	10	22	50	6		8	7	28k6	24	60	10	22	50	6
FLSES 132 SM	8	7	28k6	24	60	10	22	50	6		8	7	28k6	24	60	10	22	50	6
FLSES 160 M/L/LU	12	8	42k6	37	110	16	36	100	6		12	8	42k6	37	110	16	36	100	6
FLSES 160 MU	12	8	42k6	37	110	16	36	100	6		12	8	42k6	37	110	16	36	100	6
FLSES 160 LUR	12	8	42k6	37	110	16	36	90	20		12	8	42k6	37	110	16	36	90	20
FLSES 180 MT	14	9	48k6	42.5	110	16	36	90	20		14	9	48k6	42.5	110	16	36	90	20
FLSES 180 MUR	14	9	48k6	42.5	110	16	36	90	20		14	9	48k6	42.5	110	16	36	90	20
FLSES 180 M/MR/L/LUR	14	9	48k6	42.5	110	16	36	98	12		14	9	48k6	42.5	110	16	36	98	12
FLSES 200 LU	16	10	55m6	49	110	20	42	90	20		16	10	55m6	49	110	20	42	90	20
FLSES 225 SR/M/MR/S	18	11	60m6	53	140	20	42	125	15		16	10	55m6	49	110	20	42	90	20
FLSES 225 SG	18	11	60m6	53	140	20	42	125	15		16	10	55m6	49	110	20	42	125	15
FLSES 250 M	18	11	60m6	53	140	20	42	125	15		18	11	60m6	53	140	20	42	125	15
FLSES 250 MR	18	11	60m6	53	140	20	42	125	15		18	11	60m6	53	140	20	42	125	15
FLSES 280 S/M	20	12	70m6	62.5	140	20	42	125	15		18	11	60m6	53	140	20	42	125	15
FLSES 315 S/M	20	12	70m6	62.5	140	20	42	125	15		18	11	65m6	58	140	20	42	125	15
FLSES 315 LA/LB	20	12	70m6	62.5	140	20	42	125	15		20	12	70m6	62.5	140	20	42	125	15
FLSES 355 LA/LB/LC/LD	28	16	100m6	90	210	24	50	180	30		22	14	80m6	71	170	20	42	140	30
FLSES 355 LAL	28	16	100m6	90	210	24	50	180	30		-	-	-	-	-	-	-	-	-
FLSES 355 LKB	28	16	100m6	90	210	24	50	180	30		22	14	80m6	71	170	20	42	140	30
FLSES 355 LKC	28	16	100m6	90	210	24	50	180	30		-	-	-	-	-	-	-	-	-
FLSES 400 LB	28	16	110m6	100	210	24	50	180	30		22	14	80m6	71	170	20	42	140	30
FLSES 450 LA	32	18	120m6	109	210	24	50	180	30		-	-	-	-	-	-	-	-	-
FLSES 450 LB	32	18	120m6	109	210	24	50	180	30		-	-	-	-	-	-	-	-	-
FLSES 450 LC	32	18	120m6	109	210	24	50	180	30		-	-	-	-	-	-	-	-	-
FLSES 450 LD	32	18	120m6	109	210	24	50	180	30		-	-	-	-	-	-	-	-	-

IP55 CAST IRON MOTORS

IMfinity® 3-phase induction motors - IE2 - IE3 - IE4 - Non IE Efficiency

IP55 Cast Iron frame

Dimensions

Foot mounted IM 1001 (IM B3)

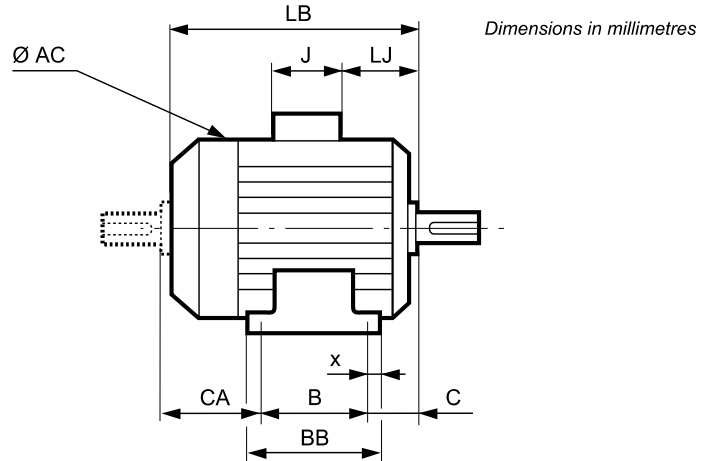
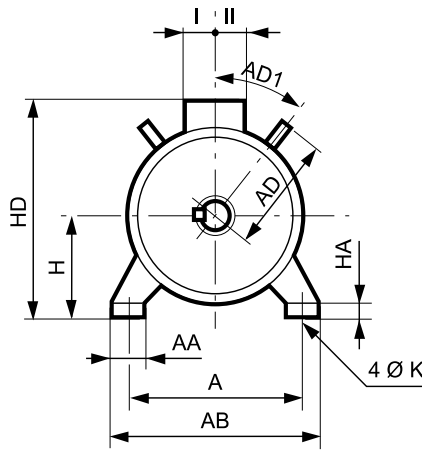

Dimensions in millimetres

Type	Main dimensions																			
	A	AB	B	BB	C	x	AA	K	HA	H	AC*	HD	LB	LJ	J	I	II	AD	AD1	CA
FLSES 80 L	125	157	100	130	50	18	34	10	10	80	170	228	212	7	136	68	68	-	-	68
FLSES 80 LU	125	157	100	130	50	18	34	10	11	80	170	228	267	7	136	68	68	-	-	120
FLSES 80 LG	125	170	100	138	50	22	39	10	10	80	203	238	245	8	136	68	68	135	41	100
FLSES 90 L	140	170	125	162	56	28	33	10	10	90	196	248	246	8	136	68	68	135	41	68
FLSES 90 LU	140	170	125	162	56	28	33	10	10	90	196	248	266	8	136	68	68	135	41	88
FLSES 90 SL	140	170	125	162	56	28	33	10	10	90	196	248	246	8	136	68	68	135	41	93
FLSES 90 S	140	170	100	162	56	28	33	10	10	90	196	248	246	8	136	68	68	135	41	95
FLSES 100 L	160	196	140	185	63	29	40	12	13	100	204	258	290	8	136	68	68	135	41	92
FLSES 100 LR	160	196	140	185	63	29	40	12	13	100	230	258	318	8	136	68	68	135	41	109
FLSES 100 LG	160	200	140	176	63	24	45	12	11	100	204	283	309	18	136	68	68	148	41	120
FLSES 100 LK	160	200	140	174	63	22	38	12	11	100	248	282	319	44	136	68	68	-	-	120
FLSES 112 M	190	230	140	186	70	32	48	12	12	112	230	294	309	18	136	68	68	148	41	109
FLSES 112 MG	190	230	140	186	70	32	48	12	12	112	230	294	309	18	136	68	68	148	41	109
FLSES 112 MU	190	230	140	186	70	32	48	12	12	112	230	294	332	18	136	68	68	148	41	128
FLSES 132 M	216	255	178	240	89	50	63	12	16	132	270	335	385	22	136	68	68	165	37.5	126
FLSES 132 MR	216	255	178	240	89	50	63	12	16	132	270	335	441	22	136	68	68	165	37.5	182
FLSES 132 MU	216	255	178	240	89	50	63	12	16	132	270	335	426	22	136	68	68	165	37.5	153
FLSES 132 SM	216	255	140	240	89	50	63	12	16	132	270	335	385	22	136	68	68	165	37.5	164
FLSES 132 S	216	255	140	240	89	50	63	12	16	132	270	335	385	22	136	68	68	165	37.5	164
FLSES 160 MUR	254	294	210	294	108	20	65	14.5	20	160	315	436	510	30	246	126	148	-	-	197
FLSES 160 LUR	254	294	254	294	108	20	65	14.5	20	160	315	436	510	30	246	126	148	-	-	153
FLSES 160 MU	254	294	210	294	108	20	65	14.5	20	160	315	436	510	30	246	126	148	-	-	197
FLSES 160 LU	254	294	254	294	108	20	65	14.5	20	160	315	436	510	30	246	126	148	-	-	153
FLSES 160 M	254	294	210	294	108	20	65	14.5	20	160	315	436	495	30	246	126	148	-	-	182
FLSES 160 L	254	294	254	294	108	20	65	14.5	20	160	315	436	495	30	246	126	148	-	-	138
FLSES 180 M	276	330	241	330	121	28	70	14.5	28	180	353	477	552	43	244	126	148	-	-	197
FLSES 180 L	279	330	279	330	121	28	70	14.5	28	180	353	477	552	43	244	126	148	-	-	159
FLSES 180 MUR	279	330	241	330	121	28	70	14.5	28	180	353	477	614	43	244	126	148	-	-	262
FLSES 180 LUR	279	330	279	330	121	28	70	14.5	28	180	353	477	614	43	244	126	148	-	-	224
FLSES 180 M	279	330	241	330	121	28	70	14.5	28	180	353	477	552	43	244	126	148	-	-	197
FLSES 180 L	279	330	279	330	121	28	70	14.5	28	180	353	477	552	43	244	126	148	-	-	159
FLSES 180 MT	279	324	241	290	121	25	80	14.5	25	180	315	456	510	31	246	126	148	200	45	155
FLSES 200 LU	318	374	305	360	133	28	60	18.5	17	200	373	528	669	49	246	126	148	230	45	244
FLSES 225 S	356	426	286	375	149	32	80	18.5	27	225	487	652	779	70	352	175	212	-	-	351
FLSES 225 M	356	426	311	375	149	32	80	18.5	27	225	487	652	779	70	352	175	212	-	-	326
FLSES 225 SR	356	426	286	375	149	32	70	18.5	17	225	391	553	676	56	246	126	148	-	-	253
FLSES 225 MR	356	426	311	375	149	32	70	18.5	17	225	391	553	676	56	246	126	148	-	-	228
FLSES 250 M	406	476	349	413	168	32	80	24	27	250	487	677	779	70	352	175	212	-	-	269
FLSES 250 S/M	406	476	349	413	168	32	80	24	27	250	487	677	779	70	352	175	212	-	-	269
FLSES 250 MR	406	476	349	413	168	32	80	24	27	250	487	677	859	71	352	175	212	-	-	408
FLSES 280 M	457	527	419	486	190	33	80	24	30	280	481	729	959	69.5	352	176	305	-	-	45
FLSES 280 S	457	527	368	486	190	33	80	24	30	280	481	729	959	69.5	352	176	305	-	-	45
FLSES 315 LA	508	600	508	610	216	58	100	28	35	315	600	840	1177	101	452	219	269	343	45	-
FLSES 315 LB	508	600	508	610	216	58	100	28	35	315	600	840	1177	101	452	219	269	343	45	-
FLSES 315 M	508	600	457	610	216	58	100	28	35	315	600	840	1177	101	452	219	269	343	45	-
FLSES 315 S	508	600	406	610	216	58	100	28	35	315	600	840	1177	101	452	219	269	343	45	-
FLSES 355 LA	610	710	630	756	254	76	100	28	35	355	688	922	1303	121	452	219	269	-	-	-
FLSES 355 LAL	610	710	630	756	254	76	100	28	35	355	688	925	1303	121	452	219	269	-	-	-
FLSES 355 LB	610	710	630	756	254	76	100	28	35	355	688	922	1303	121	452	219	269	-	-	-
FLSES 355 LC/LD	610	710	630	756	254	76	100	28	35	355	688	922	1303	121	452	219	269	-	-	-
FLSES 355 LK	610	750	630	815	254	40	128	28	45	355	787	1117	1702	52	700	224	396	-	-	-
FLSES 355 LKB	610	750	630	815	254	40	128	28	45	355	787	1117	1702	52	700	224	396	-	-	-
FLSES 355 LKC	610	750	630	815	254	40	128	28	45	355	787	1117	1702	52	700	224	396	-	-	-
FLSES 400 LB	686	800	710	815	280	65	128	35	45	400	787	1162	1702	52	700	224	396	-	-	-
FLSES 450 LA	750	890	800	950	315	94	140	35	45	450	877	1260	1740	68	700	224	396	-	-	-
FLSES 450 LB	750	890	800	950	315	94	140	35	45	450	877	1260	1740	68	700	224	396	-	-	-
FLSES 450 LC	750	890	1000	1170	315	94	140	35	45	450	877	1260	2088	68	700	224	396	-	-	-
FLSES 450 LD	750	890	1000	1170	315	94	140	35	45	450	877	1260	2088	68	700	224	396	-	-	-

* AC: housing diameter without lifting rings

IP55 CAST IRON MOTORS

IMfinity® 3-phase induction motors - IE2 - IE3 - IE4 - Non IE Efficiency

IP55 Cast Iron frame

Dimensions

Foot and flange mounted IM 2001 (IM B35)

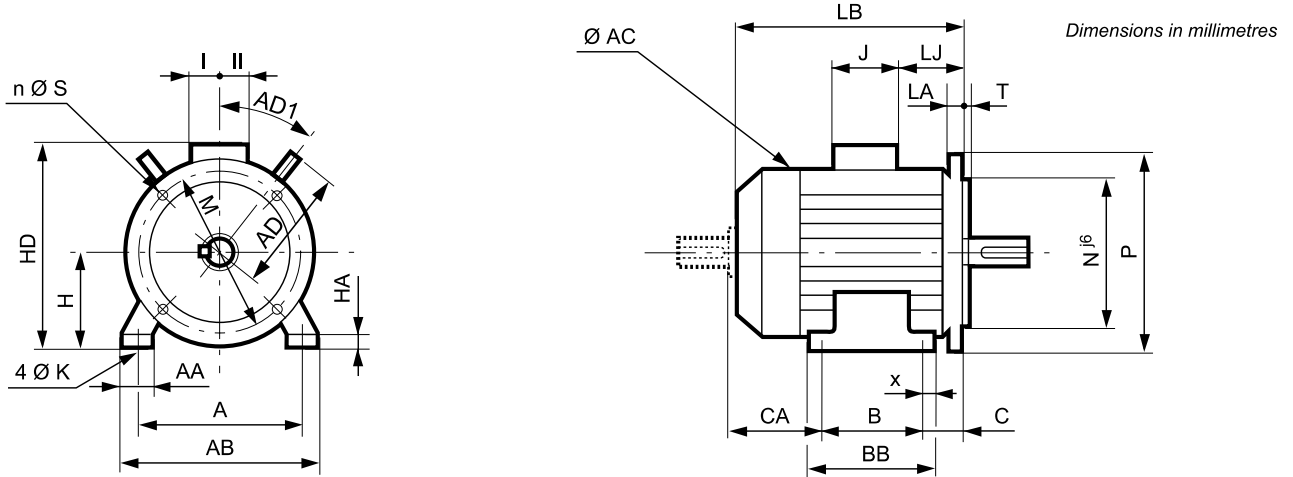

Type	Main dimensions																				
	A	AB	B	BB	C	x	AA	K	HA	H	AC*	HD	LB	LJ	J	I	II	AD	AD1	CA	Symbol
FLSES 80 L	125	157	100	130	50	18	34	10	10	80	170	228	212	7	136	68	68	-	-	68	FF 165
FLSES 80 LU	125	157	100	130	50	18	34	10	11	80	170	228	267	7	136	68	68	-	-	120	FF 165
FLSES 80 LG	125	170	100	138	70 ¹	22	39	10	10	80	203	238	265	28	136	68	68	135	41	100	FF 165
FLSES 90 L	140	170	125	162	56	28	33	10	10	90	196	248	266	28	136	68	68	135	41	68	FF 165
FLSES 90 LU	140	170	125	162	56	28	33	10	10	90	196	248	286	28	136	68	68	135	41	88	FF 165
FLSES 90 SL	140	170	125	162	56	28	33	10	10	90	196	248	266	28	136	68	68	135	41	93	FF 165
FLSES 90 S	140	170	100	162	56	28	33	10	10	90	196	248	266	28	136	68	68	135	41	95	FF 165
FLSES 100 L	160	196	140	185	63	29	40	12	13	100	204	258	290	8	136	68	68	135	41	92	FF 215
FLSES 100 LR	160	196	140	185	63	29	40	12	13	100	204	258	318	8	136	68	68	135	41	120	FF 215
FLSES 100 LG	160	200	140	176	63	24	45	12	11	100	230	283	309	18	136	68	68	148	41	109	FF 215
FLSES 100 LK	160	200	140	174	63	22	38	12	11	100	248	282	319	44	136	68	68	-	-	120	FF 215
FLSES 112 M	190	230	140	186	70	32	48	12	12	112	230	294	309	18	136	68	68	148	41	109	FF 215
FLSES 112 MG	190	230	140	186	70	32	48	12	12	112	230	294	309	18	136	68	68	148	41	109	FF 215
FLSES 112 MU	190	230	140	186	70	32	48	12	12	112	230	294	332	18	136	68	68	148	41	128	FF 215
FLSES 132 M	216	255	178	240	89	50	63	12	16	132	270	335	385	22	136	68	68	165	37.5	126	FF 265
FLSES 132 MR	216	255	178	240	89	50	63	12	16	132	270	335	441	22	136	68	68	165	37.5	182	FF 265
FLSES 132 MU	216	255	178	240	89	50	63	12	16	132	270	335	412	22	136	68	68	165	37.5	153	FF 265
FLSES 132 SM	216	255	140	240	89	50	63	12	16	132	270	335	385	22	136	68	68	165	37.5	164	FF 265
FLSES 132 S	216	255	140	240	89	50	63	12	16	132	270	335	385	22	136	68	68	165	37.5	164	FF 265
FLSES 160 MUR	254	294	210	294	108	20	65	14.5	20	160	315	436	510	30	246	126	148	-	-	197	FF 300
FLSES 160 LUR	254	294	254	294	108	20	65	14.5	20	160	315	436	510	30	246	126	148	-	-	153	FF 300
FLSES 160 MU	254	294	210	294	108	20	65	14.5	20	160	315	436	510	30	246	126	148	-	-	197	FF 300
FLSES 160 LU	254	294	254	294	108	20	65	14.5	20	160	315	436	510	30	246	126	148	-	-	153	FF 300
FLSES 160 M	254	294	210	294	108	20	65	14.5	20	160	315	436	495	30	246	126	148	-	-	182	FF 300
FLSES 160 L	254	294	254	294	108	20	65	14.5	20	160	315	436	495	30	246	126	148	-	-	138	FF 300
FLSES 180 M	279	330	241	330	121	28	70	14.5	28	180	353	477	552	43	244	126	148	-	-	197	FF 300
FLSES 180 L	279	330	279	330	121	28	70	14.5	28	180	353	477	552	43	244	126	148	-	-	159	FF 300
FLSES 180 MUR	279	330	241	330	121	28	70	14.5	28	180	353	477	614	43	244	126	148	-	-	262	FF 300
FLSES 180 LUR	279	330	279	330	121	28	70	14.5	28	180	353	477	614	43	244	126	148	-	-	224	FF 300
FLSES 180 M	279	330	241	330	121	28	70	14.5	28	180	353	477	552	43	244	126	148	-	-	197	FF 300
FLSES 180 L	279	330	279	330	121	28	70	14.5	28	180	353	477	552	43	244	126	148	-	-	159	FF 300
FLSES 180 MT	279	324	241	290	121	25	80	14.5	25	180	315	456	510	31	246	126	148	200	45	155	FF 300
FLSES 200 LU	318	374	305	360	133	28	60	18.5	17	200	373	528	669	49	246	126	148	230	45	244	FF 350
FLSES 225 S	356	426	286	375	149	32	80	18.5	27	225	487	652	779	70	352	175	212	-	-	351	FF 400
FLSES 225 M	356	426	311	375	149	32	80	18.5	27	225	487	652	779	70	352	175	212	-	-	326	FF 400
FLSES 225 SR	356	426	286	375	149	32	70	18.5	17	225	391	553	676	56	246	126	148	-	-	253	FF 400
FLSES 225 MR	356	426	311	375	149	32	70	18.5	17	225	391	553	676	56	246	126	148	-	-	228	FF 400
FLSES 250 M	406	476	349	413	168	32	80	24	27	250	487	677	779	70	352	175	212	-	-	269	FF 500
FLSES 250 S/M	406	476	349	413	168	32	80	24	27	250	487	677	779	70	352	175	212	-	-	269	FF 500
FLSES 250 MR	406	476	349	413	168	32	80	24	27	250	487	677	859	71	352	175	212	-	-	408	FF 500
FLSES 280 M	457	527	419	483	190	32	80	24	26	280	540	719	959	69.5	352	173	210	-	-	-	FF 500
FLSES 280 S	457	527	368	432	190	32	80	24	26	280	540	719	959	69.5	352	173	210	-	-	-	FF 500
FLSES 315 LA	508	600	508	610	216	58	100	28	35	315	600	840	1177	101	452	219	269	343	45	-	FF 600
FLSES 315 LB	508	600	508	610	216	58	100	28	35	315	600	840	1177	101	452	219	269	343	45	-	FF 600
FLSES 315 M	508	600	457	610	216	58	100	28	35	315	600	840	1177	101	452	219	269	343	45	-	FF 600
FLSES 315 S	508	600	406	610	216	58	100	28	35	315	600	840	1177	101	452	219	269	343	45	-	FF 600
FLSES 355 LA	610	710	630	756	254	76	100	28	35	355	688	922	1303	121	452	219	269	-	-	-	FF 740
FLSES 355 LAL	610	710	630	756	254	76	100	28	35	355	688	925	1303	121	452	219	269	-	-	-	FF 740
FLSES 355 LB	610	710	630	756	254	76	100	28	35	355	688	922	1303	121	452	219	269	-	-	-	FF 740
FLSES 355 LC/LD	610	710	630	756	254	76	100	28	35	355	688	922	1303	121	452	219	269	-	-	-	FF 740
FLSES 355 LK	610	750	630	815	254	40	128	28	45	355	787	1117	1702	52	700	224	396	-	-	-	FF 740
FLSES 355 LKB	610	750	630	815	254	40	128	28	45	355	787	1117	1702	52	700	224	396	484	55	825	FF 740
FLSES 355 LKC	610	750	630	815	254	40	128	28	45	355	787	1117	1702	52	700	224	396	484	55	825	FF 740
FLSES 400 LB	686	800	710	815	280	65	128	35	45	400	787	1162	1702	52	700	224	396	484	55	720	FF 940
FLSES 450 LA	750	890	800	950	315	94	140	35	45	450	877	1260	1740	68	700	224	396	532	55	630	FF 1080
FLSES 450 LB	750	890	800	950	315	94	140	35	45	450	877	1260	1740	68	700	224	396	532	55	630	FF 1080
FLSES 450 LC	750	890	1000	1170	315	94	140	35	45	450	877	1260	2088	68	700	224	396	505	67.5	780	FF 1080
FLSES 450 LD	750	890	1000	1170	315	94	140	35	45	450	877	1260	2088	68	700	244	396	505	67.5	780	FF 1080

* AC: housing diameter without lifting rings

1. Out of IEC

IMfinity® 3-phase induction motors - IE2 - IE3 - IE4 - Non IE Efficiency

IP55 Cast Iron frame

Dimensions

Flange mounted IM 3001 (IM B5) IM 3011 (IM V1)

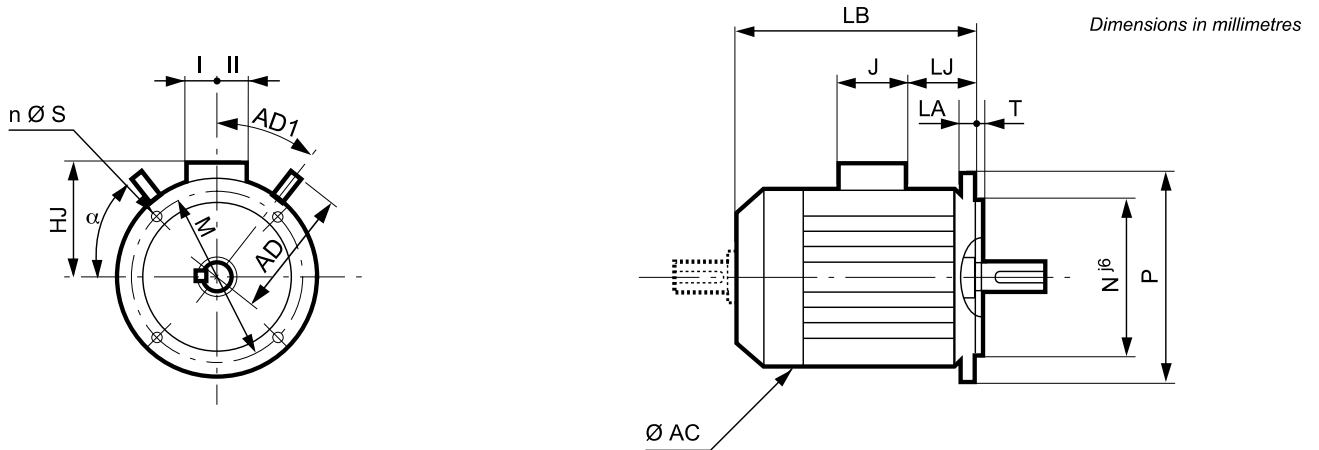

IP55 CAST IRON MOTORS

IEC symbol	Flange dimensions							
	M	N	P	T	n	α°	S	LA
FF 165	165	130	200	3.5	4	45	12	10
FF 165	165	130	200	3.5	4	45	12	10
FF 165	165	130	200	3.5	4	45	12	10
FF 165	165	130	200	3.5	4	45	12	10
FF 165	165	130	200	3.5	4	45	12	10
FF 165	165	130	200	3.5	4	45	12	10
FF 165	165	130	200	3.5	4	45	12	10
FF 215	215	180	250	4	4	45	14.5	13
FF 215	215	180	250	4	4	45	14.5	10
FF 215	215	180	250	4	4	45	14.5	10
FF 215	215	180	250	4	4	45	14.5	10
FF 215	215	180	250	4	4	45	14.5	13
FF 215	215	180	250	4	4	45	14.5	13
FF 215	215	180	250	4	4	45	14.5	13
FF 215	215	180	250	4	4	45	14.5	13
FF 215	215	180	250	4	4	45	14.5	13
FF 265	265	230	300	4	4	45	14.5	14
FF 265	265	230	300	4	4	45	14.5	14
FF 265	265	230	300	4	4	45	14.5	14
FF 265	265	230	300	4	4	45	14.5	14
FF 265	265	230	300	4	4	45	14.5	14
FF 265	265	230	300	4	4	45	14.5	14
FF 300	300	250	350	5	4	45	18.5	15
FF 300	300	250	350	5	4	45	18.5	15
FF 300	300	250	350	5	4	45	18.5	15
FF 300	300	250	350	5	4	45	18.5	15
FF 300	300	250	350	5	4	45	18.5	15
FF 300	300	250	350	5	4	45	18.5	15
FF 300	300	250	350	5	4	45	18.5	15
FF 300	300	250	350	5	4	45	18.5	15
FF 300	300	250	350	5	4	45	18.5	15
FF 300	300	250	350	5	4	45	18.5	15
FF 300	300	250	350	5	4	45	18.5	15
FF 300	300	250	350	5	4	45	18.5	15
FF 300	300	250	350	5	4	45	18.5	15
FF 300	300	250	350	5	4	45	18.5	15
FF 350	350	300	400	5	4	45	18.5	15
FF 400	400	350	450	5	8	22.5	18.5	16
FF 400	400	350	450	5	8	22.5	18.5	16
FF 400	400	350	450	5	8	22.5	18.5	16
FF 400	400	350	450	5	8	22.5	18.5	16
FF 400	400	350	450	5	8	22.5	18.5	16
FF 500	500	450	550	5	8	22.5	18.5	18
FF 500	500	450	550	5	8	22.5	18.5	18
FF 500	500	450	550	5	8	22.5	18.5	18
FF 500	500	450	550	5	8	22.5	18.5	18
FF 500	500	450	550	5	8	22.5	18.5	18
FF 600	600	550	660	6	8	22.5	24	25
FF 600	600	550	660	6	8	22.5	24	25
FF 600	600	550	660	6	8	22.5	24	25
FF 600	600	550	660	6	8	22.5	24	25
FF 600	600	550	660	6	8	22.5	24	25
FF 740	740	680	800	6	8	22.5	24	25
FF 740	740	680	800	6	8	22.5	24	25
FF 740	740	680	800	6	8	22.5	24	25
FF 740	740	680	800	6	8	22.5	24	25
FF 740	740	680	800	6	8	22.5	24	25
FF 740	740	680	800	6	8	22.5	24	25
FF 740	740	680	800	6	8	22.5	24	25
FF 740	740	680	800	6	8	22.5	24	25
FF 940	940	880	1000	6	8	22.5	28	28
FF 1080	1080	1000	1150	6	8	22.5	28	30
FF 1080	1080	1000	1150	6	8	22.5	28	30
FF 1080	1080	1000	1150	6	8	22.5	28	30
FF 1080	1080	1000	1150	6	8	22.5	28	30
FF 1080	1080	1000	1150	6	8	22.5	28	30

Type	Main dimensions									
	AC*	LB	HJ	LJ	J	I	II	AD	AD1	
FLSES 80 L	170	212	148	7	136	68	68	-	-	
FLSES 80 LU	170	267	148	7	136	68	68	-	-	
FLSES 80 LG	203	265	158	28	136	68	68	135	41	
FLSES 90 L	196	266	158	28	136	68	68	135	41	
FLSES 90 LU	196	286	158	28	136	68	68	135	41	
FLSES 90 SL	196	266	158	28	136	68	68	135	41	
FLSES 90 S	196	266	158	28	136	68	68	135	41	
FLSES 100 L	204	290	158	8	136	68	68	135	41	
FLSES 100 LR	204	318	158	8	136	68	68	135	41	
FLSES 100 LG	230	309	182	18	136	68	68	148	41	
FLSES 100 LK	248	319	182	44	136	68	68	-	-	
FLSES 112 M	230	309	182	18	136	68	68	148	41	
FLSES 112 MG	230	309	182	18	136	68	68	148	41	
FLSES 112 MU	230	332	182	18	136	68	68	148	41	
FLSES 132 M	270	385	203	22	136	68	68	165	37.5	
FLSES 132 MR	270	441	203	22	136	68	68	165	37.5	
FLSES 132 MU	270	412	203	22	136	68	68	165	37.5	
FLSES 132 SM	270	385	203	22	136	68	68	165	37.5	
FLSES 132 S	270	385	203	22	136	68	68	165	37.5	
FLSES 160 MUR	315	510	276	30	246	126	148	-	-	
FLSES 160 LUR	315	510	276	30	246	126	148	-	-	
FLSES 160 MU	315	510	276	30	246	126	148	-	-	
FLSES 160 LU	315	510	276	30	246	126	148	-	-	
FLSES 160 M	315	495	276	30	246	126	148	-	-	
FLSES 160 L	315	495	276	30	246	126	148	-	-	
FLSES 180 M	353	552	297	43	244	126	148	-	-	
FLSES 180 L	353	552	297	43	244	126	148	-	-	
FLSES 180 MUR	353	614	297	43	244	126	148	-	-	
FLSES 180 LUR	353	614	297	43	244	126	148	-	-	
FLSES 180 MU	353	552	297	43	244	126	148	-	-	
FLSES 180 L	353	552	297	43	244	126	148	-	-	
FLSES 180 MT	315	510	276	31	246	126	148	200	45	
FLSES 200 LU	373	669	328	49	246	126	148	230	45	
FLSES 225 S	487	779	427	70	352	175	212	-	-	
FLSES 225 M	487	779	427	70	352	175	212	-	-	
FLSES 225 SR	391	676	328	56	246	126	148	-	-	
FLSES 225 MR	391	676	328	56	246	126	148	-	-	
FLSES 250 M	487	779	427	70	352	175	212	-	-	
FLSES 250 S/M	487	779	427	70	352	175	212	-	-	
FLSES 250 MR	487	859	427	71	352	175	212	-	-	
FLSES 280 M	540	959	439	69.5	352	173	210	-	-	
FLSES 280 S	540	959	439	69.5	352	173	210	-	-	
FLSES 315 LA	600	1177	525	101	452	219	269	343	45	
FLSES 315 LB	600	1177	525	101	452	219	269	343	45	
FLSES 315 M	600	1177	525	101	452	219	269	343	45	
FLSES 315 S	600	1177	525	101	452	219	269	343	45	
FLSES 355 LA	688	1303	567	121	452	219	269	-	-	
FLSES 355 LAL	688	1303	567	121	452	219	269	-	-	
FLSES 355 LB	688	1303	567	121	452	219	269	-	-	
FLSES 355 LC/LD	688	1303	567	121	452	219	269	-	-	
FLSES 355 LK	787	1702	762	52	700	224	396	-	-	
FLSES 355 LKB	787	1702	762	52	700	224	396	456	67.5	
FLSES 355 LKC	787	1702	762	52	700	224	396	456	67.5	
FLSES 400 LB	787	1702	762	52	700	224	396	456	67.5	
FLSES 450 LA	877	1740	810	68	700	224	396	517	67.5	
FLSES 450 LB	877	1740	810	68	700	224	396	517	67.5	
FLSES 450 LC	877	1740	810	68	700	224	396	517	67.5	
FLSES 450 LD	877	1740	810	68	700	224	396	517	67.5	

* AC: housing diameter without lifting rings

IMfinity® 3-phase induction motors - IE2 - IE3 - IE4 - Non IE Efficiency

IP55 Cast Iron frame

Dimensions

Foot and face mounted IM 2101 (IM B34)

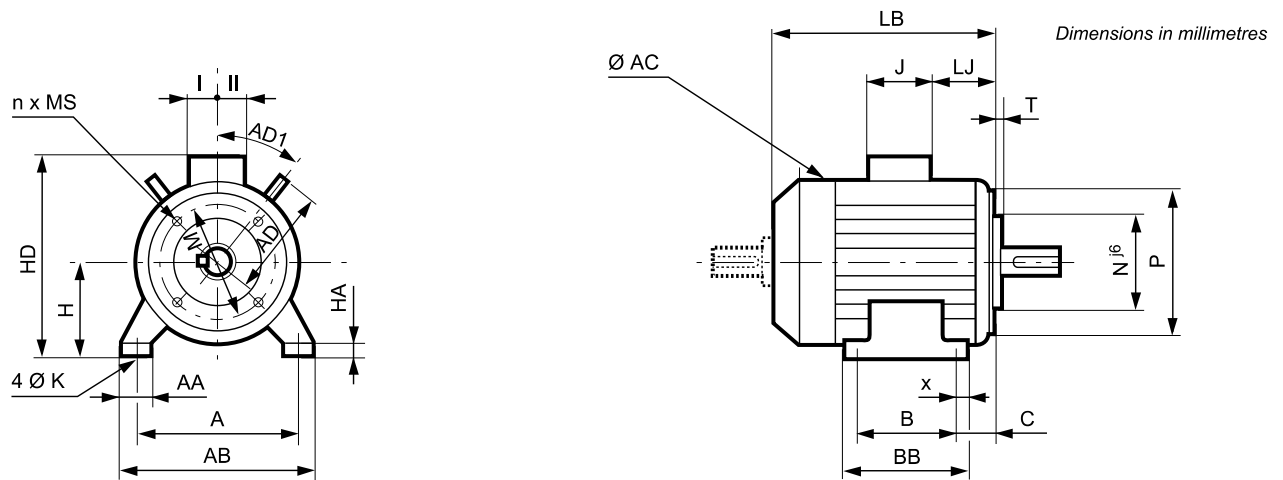

Type	Main dimensions																			Symbol	
	A	AB	B	BB	C	x	AA	K	HA	H	AC*	HD	LB	LJ	J	I	II	AD	AD1		CA
FLSES 80 L	125	157	100	130	50	18	34	10	10	80	170	228	212	7	136	68	68	-	-	68	FT 100
FLSES 80 LU	125	157	100	130	50	18	34	10	10	80	170	228	267	7	136	68	68	-	-	120	FT 100
FLSES 80 LG	125	170	100	138	50	22	39	10	10	80	203	238	245	8	136	68	68	135	41	100	FT 100
FLSES 90 L	140	170	125	162	56	28	33	10	10	90	196	248	246	8	136	68	68	135	41	68	FT 115
FLSES 90 LU	140	170	125	162	56	28	33	10	10	90	196	248	266	8	136	68	68	135	41	88	FT 115
FLSES 90 SL	140	170	100	162	56	28	33	10	10	90	196	248	246	8	136	68	68	135	41	93	FT 115
FLSES 90 S	140	170	100	162	56	28	33	10	10	90	196	248	246	8	136	68	68	135	41	95	FT 115
FLSES 100 L	160	196	140	185	63	29	40	12	13	100	204	258	290	8	136	68	68	135	41	92	FT 130
FLSES 100 LR	160	196	140	185	63	29	40	12	13	100	204	258	318	8	136	68	68	135	41	120	FT 130
FLSES 100 LG	160	200	140	176	63	24	45	12	11	100	230	283	309	18	136	68	68	148	41	109	FT 130
FLSES 100 LK	160	200	140	174	63	22	38	12	11	100	248	283	319	44	136	68	68	-	-	120	FT 130
FLSES 112 M	190	230	140	186	70	32	48	12	12	112	230	294	309	18	136	68	68	148	41	109	FT 130
FLSES 112 MG	190	230	140	186	70	32	48	12	12	112	230	294	309	18	136	68	68	148	41	109	FT 130
FLSES 112 MU	190	230	140	186	70	32	48	12	12	112	230	294	332	18	136	68	68	148	41	128	FT 130
FLSES 132 M	216	255	178	240	89	50	63	12	16	132	270	335	385	22	136	68	68	165	37.5	126	FT 165
FLSES 132 MR	216	255	178	240	89	50	63	12	16	132	270	335	441	22	136	68	68	165	37.5	182	FT 165
FLSES 132 MU	216	255	178	240	89	50	63	12	16	132	270	335	412	22	136	68	68	165	37.5	153	FT 165
FLSES 132 SM	216	255	140	240	89	50	63	12	16	132	270	335	385	22	136	68	68	165	37.5	164	FT 165
FLSES 132 S	216	255	140	240	89	50	63	12	16	132	270	335	385	22	136	68	68	165	37.5	164	FT 165

* AC: housing diameter without lifting rings

IMfinity® 3-phase induction motors - IE2 - IE3 - IE4 - Non IE Efficiency

IP55 Cast Iron frame

Dimensions

Face mounted IM 3601 (IM B14)

Dimensions in millimetres

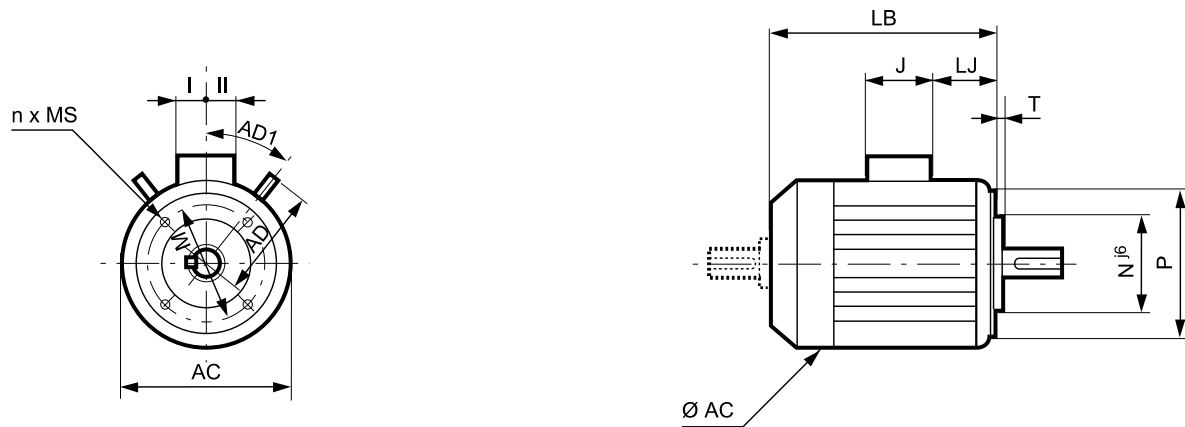

IEC symbol	Faceplate dimensions						
	M	N	P	T	n	α°	MS
FT 100	100	80	120	3	4	45	M6
FT 100	100	80	120	3	4	45	M6
FT 100	100	80	120	3	4	45	M6
FT 115	115	95	140	3	4	45	M8
FT 115	115	95	140	3	4	45	M8
FT 115	115	95	140	3	4	45	M8
FT 115	115	95	140	3	4	45	M8
FT 130	130	110	160	3.5	4	45	M8
FT 130	130	110	160	3.5	4	45	M8
FT 130	130	110	160	3.5	4	45	M8
FT 130	130	110	160	3.5	4	45	M8
FT 130	130	110	160	3.5	4	45	M8
FT 130	130	110	160	3.5	4	45	M8
FT 165	165	130	200	3.5	4	45	M10
FT 165	165	130	200	3.5	4	45	M10
FT 165	165	130	200	3.5	4	45	M10
FT 165	165	130	200	3.5	4	45	M10
FT 165	165	130	200	3.5	4	45	M10

Type	Main dimensions								
	AC*	LB	HJ	LJ	J	I	II	AD	AD1
FLSES 80 L	170	212	148	7	136	68	68	-	-
FLSES 80 LU	170	267	148	7	136	68	68	-	-
FLSES 80 LG	203	245	158	8	136	68	68	135	41
FLSES 90 L	196	246	158	8	136	68	68	135	41
FLSES 90 LU	196	266	158	8	136	68	68	135	41
FLSES 90 SL	196	246	158	8	136	68	68	135	41
FLSES 90 S	196	246	158	8	136	68	68	135	41
FLSES 100 L	204	290	158	8	136	68	68	135	41
FLSES 100 LR	230	318	158	18	136	68	68	135	41
FLSES 100 LG	204	309	182	8	136	68	68	148	41
FLSES 100 LK	248	319	182	44	136	68	68	-	-
FLSES 112 M	230	309	182	18	136	68	68	148	41
FLSES 112 MG	230	309	182	18	136	68	68	148	41
FLSES 112 MU	230	332	182	18	136	68	68	148	41
FLSES 132 M	270	385	203	22	136	68	68	165	37.5
FLSES 132 MR	270	441	203	22	136	68	68	165	37.5
FLSES 132 MU	270	412	203	22	136	68	68	165	37.5
FLSES 132 SM	270	385	203	22	136	68	68	165	37.5
FLSES 132 S	270	385	203	22	136	68	68	165	37.5

* AC: housing diameter without lifting rings

IMfinity® 3-phase induction motors - IE2 - IE3 - IE4 - Non IE Efficiency

IP55 Cast Iron frame

Construction

Bearings and lubrication

PERMANENTLY GREASED BEARINGS

Under normal operating conditions, the service life in hours of the bearing is indicated in the table below for ambient temperatures less than 55°C.

Series	Type	No. of poles	Types of permanently greased bearing		Bearing life according to speed of rotation								
					3000 min ⁻¹			1500 min ⁻¹			1000 min ⁻¹		
					25°C	40°C	55°C	25°C	40°C	55°C	25°C	40°C	55°C
FLSES	80 L	2	6203 CN	6204 C3	≥40000	≥40000	25000	-	-	-	-	-	-
	80 LG	4	6204 C3	6205 C3	-	-	-	≥40000	≥40000	31000	-	-	-
	90 SL/L	2; 4 ; 6			≥40000	≥40000	24000				≥40000	≥40000	34000
	90 LU	2; 6	6205 C3	6205 C3	≥40000	≥40000	24000	-	-	-	≥40000	≥40000	34000
	100 L	2; 4	6205 C3	6206 C3	≥40000	≥40000	22000	≥40000	≥40000	30000	-	-	-
	100 LG	4; 6			-	-	-				≥40000	≥40000	33000
	112 MG	2; 6			≥40000	≥40000	22000				-	-	-
	112 MU	4	6206 C3	6206 C3	-	-	-	≥40000	≥40000	30000	-	-	-
	132 SM/M	2; 4; 6	6207 C3	6308 C3	≥40000	≥40000	19000	≥40000	≥40000	25000	≥40000	≥40000	30000
	132 MU	2; 4	6307 C3	6308 C3	≥40000	≥40000	19000	≥40000	≥40000	25000	-	-	-
	132 MR	4; 6	6308 C3	6308 C3	-	-	-	≥40000	≥40000	25000	≥40000	≥40000	30000
	160 M	2; 4; 6	6210 C3	6309 C3	≥40000	37800	18900	≥40000	≥40000	36900	≥40000	≥40000	20050
	160 MU	6			-	-	-	-	-	-			
	160 LUR	2; 4 ; 6	6210 C3	6310 C3	≥40000	24500	12250	≥40000	36400	18200	≥40000	≥40000	22450
	180 M	2	6212 C3	6310 C3	34000	17000	8500	-	-	-	-	-	-
	180 MT	4	6210 C3	6310 C3	-	-	-	≥40000	35500	17750	-	-	-
	180 MUR	2	6312 C3	6310 C3	≥40000	22800	11400	-	-	-	-	-	-
	180 L	4; 6	6212 C3	6310 C3	-	-	-	≥40000	39500	19750	≥40000	≥40000	29050
	180 LUR	4; 6	6312 C3	6310 C3	-	-	-	≥40000	≥40000	22900	≥40000	≥40000	29900
	200 LU	2; 4; 6	6312 C3	6312 C3	28600	14300	7150	≥40000	25400	12700	≥40000	33200	16600
225 S	4	6314 C3	6314 C3	-	-	-	≥40000	23700	11850	-	-	-	
225 SR	4	6312 C3	6313 C3	-	-	-	≥40000	≥40000	21500	-	-	-	
225 M	4; 6	6314 C3	6314 C3	-	-	-	≥40000	23700	11850	≥40000	25600	12800	
225 MR	2	6312 C3	6313 C3	≥40000	22800	11400	-	-	-	-	-	-	

Note: On request, all motors can be fitted with grease nipples.

IMfinity® 3-phase induction motors - IE2 - IE3 - IE4 - Non IE Efficiency

IP55 Cast Iron frame

Construction

Bearings and lubrication

BEARINGS WITH GREASE NIPPLES

The chart opposite shows the greasing intervals, depending on the type of motor, for standard bearing assemblies of frame size ≥ 160 mm fitted with grease nipples, operating at an ambient temperature of 25°C, 40°C and 55°C on a horizontal shaft machine.

SPECIAL CONSTRUCTION AND ENVIRONMENT

For vertical shaft machines, the greasing intervals will be approximately 80% of the values stated in the table below.

Note: The quality and quantity of grease and the greasing interval are shown on the machine nameplate.

For special assemblies (motors fitted with DE roller bearings or other types), machines of frame size ≥ 160 mm have bearings with grease nipples.

Instructions for bearing maintenance are given on the nameplates on these machines

The chart below is valid for FLSES motors lubricated with Polyrex EM103 grease which is used as standard.

Series	Type	No. of poles	Type of bearing for bearings with grease nipples		Quantity of grease g	Greasing intervals in hours								
			N.D.E.	D.E.		3000 min ⁻¹			1500 min ⁻¹			1000 min ⁻¹		
						25°C	40°C	55°C	25°C	40°C	55°C	25°C	40°C	55°C
FLSES	160 M*	2; 4; 6	6210 C3	6309 C3	13	22200	11100	5550	32400	16200	8100	39800	19900	9950
	160 MU	6				-	-	-	-	-	-	23400	11700	5850
	160 LUR*	2; 4; 6	6210 C3	6310 C3	15	19600	9800	4900	30400	15200	7600	38200	19100	6600
	180 M*	2	6212 C3	6310 C3	15	18000	9000	4500	-	-	-	-	-	-
	180 MT*	4	6210 C3	6310 C3	15	-	-	-	30400	15200	7600	-	-	-
	180 MUR*	2	6312 C3	6310 C3	15	10600	5300	2650	-	-	-	-	-	-
	180 L*	4; 6	6212 C3	6310 C3	20	-	-	-	29200	14600	7300	37200	18600	9300
	180 LUR*	4; 6	6312 C3	6310 C3	20	-	-	-	26800	13400	6700	35000	17500	8750
	200 LU*	2; 4; 6	6312 C3	6312 C3	20	15200	7600	3800	26800	13400	6700	35000	17500	8750
	225 S*	4	6314 C3	6314 C3	25	-	-	-	23600	11800	5900	-	-	-
	225 SR*	4	6312 C3	6313 C3	25	-	-	-	25200	12600	6300	-	-	-
	225 M*	4; 6	6314 C3	6314 C3	25	-	-	-	23600	11800	5900	32200	16100	8050
	225 MR*	2	6312 C3	6313 C3	25	13400	6700	3350	-	-	-	-	-	-
	250 M	2; 6	6314 C3	6314 C3	25	10400	5200	2600	-	-	-	32200	16100	8050
	250 MR	4				-	-	-	17800	8900	4450	-	-	-
	280 S/M	2; 4; 6	6314 C3	6316 C3	35	7200	3600	1800	21000	13230	6615	29000	29000	18270
	315 S/M/L	2	6316 C3	6218 C3	35	7400	5880	2920	-	-	-	-	-	-
	315 S/M/L	4; 6	6316 C3	6320 C3	50	-	-	-	15600	12400	6160	25000	25000	12500
	355 L	2	6316 C3	6218 C3	35	7400	3700	1850	-	-	-	-	-	-
	355 L	4; 6	6316 C3	6322 C3	60	-	-	-	13200	8316	4160	22000	13860	6930
	355 LKB	4; 6	6324 C3	6324 C3	72	-	-	-	7500	3700	2800	20000	20000	10000
	355 LKB	2	6317 C4	6317 C4	37	6600	5200	2600	-	-	-	-	-	-
	355 LKC	6	6324 C3	6324 C3	72	-	-	-	-	-	-	20000	17000	8500
	400 LB	2	6317 C4	6317 C4	37	6600	5200	2600	-	-	-	-	-	-
400 LB	4	6324 C3	6324 C3	72	-	-	-	7500	3700	2800	-	-	-	
450 LA	4	6328 C3	6328 C3	93	-	-	-	4600	2300	1100	-	-	-	
450 LA	6	6328 C3	6328 C3	93	-	-	-	-	-	-	10000	6000	3000	
450 LB	4	6328 C3	6328 C3	93	-	-	-	4600	2300	1100	-	-	-	
450 LB	6	6328 C3	6328 C3	93	-	-	-	-	-	-	10000	6000	3000	
450 LC	6	6328 C3	6328 C3	93	-	-	-	-	-	-	10000	6000	3000	
450 LD	4	6328 C3	6328 C3	93	-	-	-	4600	2300	1100	-	-	-	

* bearing with grease nipples on request

STANDARD BEARING FITTING ARRANGEMENTS

FLSES series		Horizontal shaft	Vertical shaft	
Foot mounted motors	Mounting arrangement	B3	Shaft facing down	Shaft facing up
	standard mounting	The DE bearing is: - located at DE for frame ≤ 132 - locked for frame ≥ 160	V5	V6
	on request	DE bearing locked for frame < 132	The DE bearing is locked	The DE bearing is: - located at DE for frame ≤ 90 - locked for frame ≥ 100
Flange mounted motors (or foot and flange)	Mounting arrangement	B5 / B35 / B14 / B34	V1 / V15 / V18 / V58	V3 / V36 / V19 / V69
	standard mounting	The DE bearing is locked on frames 80 to 355LD	The DE bearing is locked on frames 80 to 355LD	The DE bearing is locked on frames 80 to 355LD
		The NDE bearing is locked on frames 355LK to 450	The NDE bearing is locked on frames 355LK to 450	The NDE bearing is locked on frames 355LK to 450

IMfinity® 3-phase induction motors - IE2 - IE3 - IE4 - Non IE Efficiency

IP55 Cast Iron frame

Construction

Axial loads

HORIZONTAL MOTOR

For a bearing life L_{10h}
of 25,000 hours
and 40,000 hours

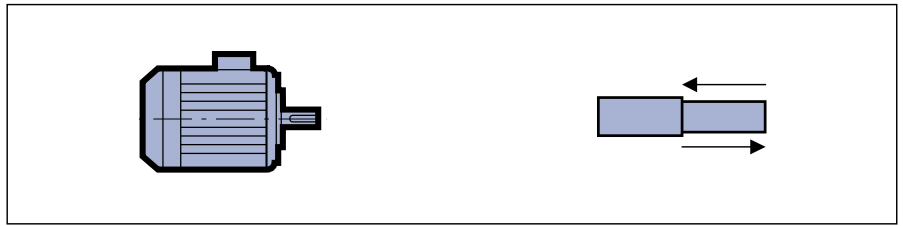

Series	Type	No. of poles	Permissible axial load (in daN) on main shaft extension for standard bearing assembly													
			3000 min ⁻¹						1500 min ⁻¹				1000 min ⁻¹			
			→		←		→		←		→		←			
			25,000 hours	40,000 hours	25,000 hours	40,000 hours	25,000 hours	40,000 hours	25,000 hours	40,000 hours	25,000 hours	40,000 hours	25,000 hours	40,000 hours		
FLSES	80 L	2	30	21	(60)	(51)	-	-	-	-	-	-	-	-		
	80 LG	2; 4	28	19	(68)	(59)	48	34	(88)	(74)	-	-	-	-		
	90 SL/L	2; 4; 6	29	23	(69)	(56)	45	32	(85)	(72)	56	40	(96)	(80)		
	90 LU	2; 4; 6	22	13	(72)	(63)	38	25	(88)	(75)	47	32	(97)	(82)		
	100 L	2; 4	40	26	(90)	(76)	61	43	(111)	(93)	-	-	-	-		
	100 LR	4	-	-	-	-	61	43	(111)	(93)	-	-	-	-		
	100 LG	4; 6	-	-	-	-	55	38	(105)	(88)	75	53	(125)	(103)		
	112 MG	2; 6	37	24	(87)	(74)	-	-	-	-	82	61	(132)	(111)		
	112 MU	4; 6	-	-	-	-	54	36	(114)	(96)	66	45	(126)	(105)		
	132 SM/M	2; 4; 6	101	74	(171)	(144)	146	109	(216)	(179)	182	138	(252)	(208)		
	132 MU	6	-	-	-	-	-	-	-	-	169	126	(249)	(206)		
	132 MR	4	-	-	-	-	129	93	(219)	(183)	-	-	-	-		
	160 M	2; 4	129	94	229	194	187	140	287	240	234	177	334	277		
	160 MU	6	-	-	-	-	-	-	-	-	219	164	319	264		
	160 L	2; 4	118	83	218	183	195	148	295	248	-	-	-	-		
	160 LUR	2; 4; 6	158	117	258	217	212	158	312	258	257	193	357	293		
	180 M	2; 4	189	148	237	196	228	174	291	237	-	-	-	-		
	180 MT	4	-	-	-	-	215	161	315	261	-	-	-	-		
	180 MUR	2	178	137	241	200	-	-	-	-	-	-	-	-		
	180 L	4; 6	-	-	-	-	240	186	288	234	272	208	320	256		
	180 LUR	4; 6	-	-	-	-	224	170	287	233	224	162	287	225		
	200 LU	2; 4; 6	249	196	312	259	316	245	379	308	327	245	390	308		
	225 S	4	-	-	-	-	427	336	490	399	-	-	-	-		
	225 SR	4	-	-	-	-	370	290	433	353	-	-	-	-		
	225 M	4; 6	-	-	-	-	416	325	496	405	511	402	591	482		
	225 MR	2	280	220	343	283	-	-	-	-	-	-	-	-		
	250 M	2; 6	308	240	388	320	-	-	-	-	506	400	506	400		
	250 MR	4	-	-	-	-	413	322	493	402	-	-	-	-		
	280 S/M	2; 4; 6	342	258	484	400	483	372	625	514	581	445	723	587		
	315 S/M/LA/LB	2; 6	411	348	165	102	-	-	-	-	933	761	687	515		
	315 S/M/LA/LB	4	-	-	-	-	814	670	568	424	-	-	-	-		
	355 LA/LB/LC	2	393	333	147	87	-	-	-	-	-	-	-	-		
	355 LAL	4	-	-	-	-	876	724	630	478	-	-	-	-		
	355 LA/LB/LC	4; 6	-	-	-	-	876	724	630	478	947	764	701	518		
	355 LKA	6	-	-	-	-	-	-	-	-	937	760	615	440		
	355 LKB	2	435	-	266	-	-	-	-	-	-	-	-	-		
	355 LKB	4	-	-	-	-	843	-	530	-	-	-	-	-		
	355 LKB	6	-	-	-	-	-	-	-	-	897	725	577	405		
	355 LKC	6	-	-	-	-	-	-	-	-	964	-	596	-		
	400 LB	2	435	-	266	-	-	-	-	-	-	-	-	-		
	400 LB	4	-	-	-	-	862	-	582	-	-	-	-	-		
	450 LA	4; 6	-	-	-	-	1061	-	707	-	1179	-	808	-		
	450 LB/LC/LD	4; 6	-	-	-	-	1041	-	687	-	1162	-	941	-		

(): axial loads permissible with DE bearing locked

IP55 CAST IRON MOTORS

IMfinity® 3-phase induction motors - IE2 - IE3 - IE4 - Non IE Efficiency

IP55 Cast Iron frame

Construction

Axial loads

VERTICAL MOTOR SHAFT FACING DOWN

For a bearing life L_{10h}
of 25,000 hours
and 40,000 hours

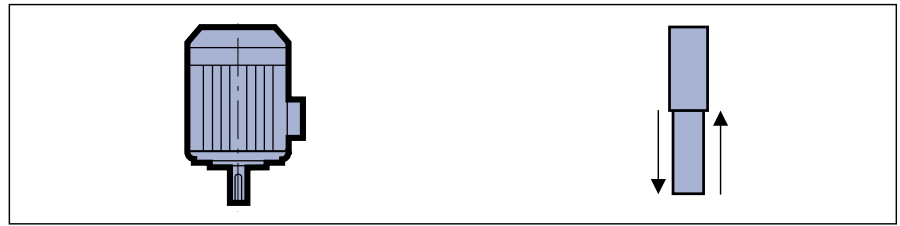

IP55 CAST IRON MOTORS

Series	Type	No. of poles	Permissible axial load (in daN) on main shaft extension for standard bearing assembly											
			IM V5 IM V1 / V15 IM V18 / V58											
			3000 min ⁻¹				1500 min ⁻¹				1000 min ⁻¹			
			25,000 hours	40,000 hours	25,000 hours	40,000 hours	25,000 hours	40,000 hours	25,000 hours	40,000 hours	25,000 hours	40,000 hours	25,000 hours	40,000 hours
	80 L	2	29	20	(63)	(54)	-	-	-	-	-	-	-	-
	80 LG	2; 4	26	16	(72)	(62)	45	32	(93)	(78)	-	-	-	-
	90 SL/L	2; 4; 6	26	16	(73)	(63)	42	28	(91)	(78)	53	37	(101)	(86)
	90 LU	2; 4; 6	19	9	(77)	(67)	33	20	(95)	(82)	43	28	(105)	(89)
	100 L	2; 4	36	23	(96)	(83)	56	38	(119)	(101)	-	-	-	-
	100 LR	4	-	-	-	-	55	37	(120)	(102)	-	-	-	-
	100 LG	4; 6	-	-	-	-	48	31	(116)	(99)	68	46	(137)	(115)
	112 MG	2; 6	31	18	(98)	(85)	-	-	-	-	75	53	(145)	(123)
	112 MU	4; 6	-	-	-	-	45	28	(128)	(110)	57	36	(140)	(119)
	132 SM/M	2; 4; 6	90	62	(189)	(161)	135	98	(235)	(198)	171	127	(271)	(227)
	132 MU	6	-	-	-	-	-	-	-	-	154	110	(275)	(231)
	132 MR	4	-	-	-	-	113	77	(245)	(208)	-	-	-	-
	160 M	2; 4; 6	107	72	264	229	164	117	325	277	209	152	374	317
	160 MU	6	-	-	-	-	-	-	-	-	189	133	375	319
	160 L	2; 4	94	59	256	221	174	126	331	284	-	-	-	-
	160 LUR	2; 4; 6	133	92	297	256	185	130	362	308	227	162	417	352
	180 M	2; 4	160	119	279	238	187	132	361	306	-	-	-	-
	180 MT	4	-	-	-	-	190	135	361	306	-	-	-	-
	180 MUR	2	144	102	294	252	-	-	-	-	-	-	-	-
	180 L	4; 6	-	-	-	-	206	151	346	291	233	169	391	326
	180 LUR	4; 6	-	-	-	-	187	132	355	300	183	120	377	314
FLSES	200 LU	2; 4; 6	207	153	375	320	262	190	471	398	269	186	505	422
	225 S	4	-	-	-	-	351	260	611	520	-	-	-	-
	225 SR	4	-	-	-	-	317	236	520	438	-	-	-	-
	225 M	4; 6	-	-	-	-	333	241	627	535	428	319	723	613
	225 MR	2	234	174	413	352	-	-	-	-	-	-	-	-
	250 M	2; 6	247	179	481	413	-	-	-	-	423	315	647	539
	250 MR	4	-	-	-	-	315	223	639	547	-	-	-	-
	280 S/M	2; 4; 6	396	307	484	395	507	394	670	557	602	461	793	651
	315 S/M/LA/LB	2; 6	226	156	417	347	-	-	-	-	-	-	-	-
	315 S/M/LA/LB	4	-	-	-	-	601	449	893	741	683	515	1042	873
	355 LA/LB/LC	2	135	65	524	454	-	-	-	-	-	-	-	-
	355 LAL	4	-	-	-	-	516	350	1123	957	-	-	-	-
	355 LA/LB/LC	4; 6	-	-	-	-	516	350	1123	957	566	364	1328	1126
	355 LKA	6	-	-	-	-	-	-	-	-	650	442	1349	1140
	355 LKB	2	965	-	271	-	-	-	-	-	-	-	-	-
	355 LKB	4	-	-	-	-	2442	-	361	-	-	-	-	-
	355 LKB	6	-	-	-	-	-	-	-	-	393	185	1624	1416
	355 LKC	6	-	-	-	-	-	-	-	-	2722	-	706	-
	400 LB	2	965	-	271	-	-	-	-	-	-	-	-	-
	400 LB	4	-	-	-	-	2442	-	361	-	-	-	-	-
450 LA	4; 6	-	-	-	-	868	-	1247	-	791	-	1668	-	
450 LB/LC/LD	4; 6	-	-	-	-	729	-	1366	-	671	-	1772	-	

(): axial loads permissible with DE bearing locked

IMfinity® 3-phase induction motors - IE2 - IE3 - IE4 - Non IE Efficiency

IP55 Cast Iron frame

Construction

Axial loads

VERTICAL MOTOR SHAFT FACING UP

For a bearing life L_{10h}
of 25,000 hours
and 40,000 hours

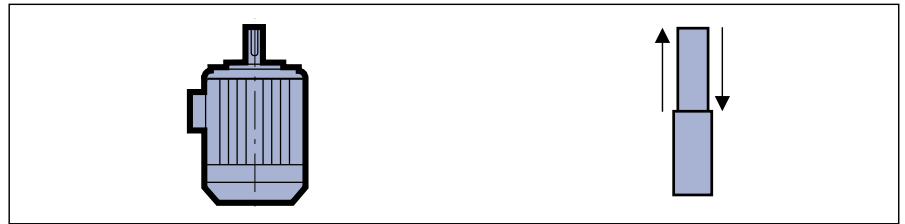

Series	Type	No. of poles	Permissible axial load (in daN) on main shaft extension for standard bearing assembly											
			3000 min ⁻¹				1500 min ⁻¹				1000 min ⁻¹			
			25,000 hours	40,000 hours	25,000 hours	40,000 hours	25,000 hours	40,000 hours	25,000 hours	40,000 hours	25,000 hours	40,000 hours	25,000 hours	40,000 hours
IM V6 IM V3 / V36 IM V19 / V69														
FLSES	80 L	2	(59)	(50)	33	24	-	-	-	-	-	-	-	-
	80 LG	2; 4	(66)	(56)	32	22	(85)	(71)	53	39	-	-	-	-
	90 SL/L	2; 4; 6	(66)	(56)	33	23	(82)	(68)	51	38	(93)	(77)	61	46
	90 LU	2; 4; 6	(69)	(59)	27	18	(81)	(76)	43	38	(93)	(82)	55	32
	100 L	2	(86)	(72)	46	33	(106)	(88)	69	51	-	-	-	-
	100 LR	4	-	-	-	-	(105)	(87)	70	52	-	-	-	-
	100 LG	4; 6	-	-	-	-	(98)	(81)	67	49	(118)	(96)	87	66
	112 MG	2; 6	(81)	(68)	48	35	-	-	-	-	(125)	(103)	95	73
	112 MU	4; 6	-	-	-	-	(105)	(88)	68	50	(117)	(96)	80	60
	132 SM/M	2; 4; 6	(159)	(132)	120	91	(205)	(168)	165	128	(249)	(205)	179	135
	132 MU	6	-	-	-	-	-	-	-	-	(234)	(190)	195	151
	132 MR	4	-	-	-	-	(203)	(167)	155	118	-	-	-	-
	160 M	2; 4; 6	207	172	164	129	264	217	225	177	309	252	274	217
	160 MU	6	-	-	-	-	-	-	-	-	289	233	275	219
	160 L	2; 4	194	159	156	121	274	226	231	184	-	-	-	-
	160 LUR	2; 4; 6	233	192	197	156	285	230	262	208	327	262	317	252
	180 M	2; 4	208	167	231	190	250	195	298	243	-	-	-	-
	180 MT	4	-	-	-	-	290	235	261	206	-	-	-	-
	180 MUR	2	207	165	231	189	-	-	-	-	-	-	-	-
	180 L	4; 6	-	-	-	-	254	199	298	243	281	217	343	278
	180 LUR	4; 6	-	-	-	-	250	195	292	237	246	183	314	251
	200 LU	2; 4; 6	270	216	312	257	325	253	408	335	332	249	442	359
	225 S	4	-	-	-	-	414	323	548	457	-	-	-	-
	225 SR	4	-	-	-	-	380	299	457	375	-	-	-	-
	225 M	4; 6	-	-	-	-	413	321	547	455	508	399	643	533
	225 MR	2	297	237	350	289	-	-	-	-	-	-	-	-
	250 M	2; 6	327	259	401	333	-	-	-	-	423	315	647	539
	250 MR	4	-	-	-	-	395	303	559	467	-	-	-	-
	280 S/M	2; 4; 6	396	307	484	395	507	394	670	557	602	461	793	651
	315 S/M/L	2	226	156	417	347	-	-	-	-	-	-	-	-
	315 S/M/L	4; 6	-	-	-	-	601	449	893	741	683	515	1042	873
	355 L	2	135	65	524	454	-	-	-	-	-	-	-	-
355 L	4; 6	-	-	-	-	516	350	1123	957	566	364	1328	1126	
355 LKB	2	355 LK, 400 and 450: Please consult Leroy-Somer while specifying the coupling mode and any radial and axial loads.												
355 LKB	4; 6													
355 LKC	6													
400 LB	2													
400 LB	4													
450 LA	4; 6													
450 LB/LC/LD	4; 6													

400 and 450: Please consult Leroy-Somer

(): axial loads permissible with DE bearing locked

IP55 CAST IRON MOTORS

IMfinity® 3-phase induction motors - IE2 - IE3 - IE4 - Non IE Efficiency

IP55 Cast Iron frame

Construction

Radial loads

STANDARD FITTING ARRANGEMENT

Permissible radial load on main shaft extension with a bearing life L_{10h} of 25,000 hours.

FR : Radial Force

X: Distance with respect to the shaft shoulder

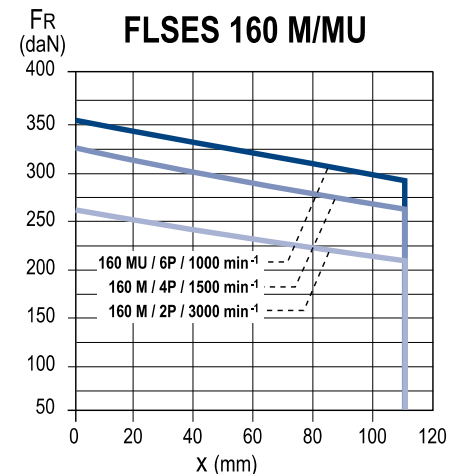
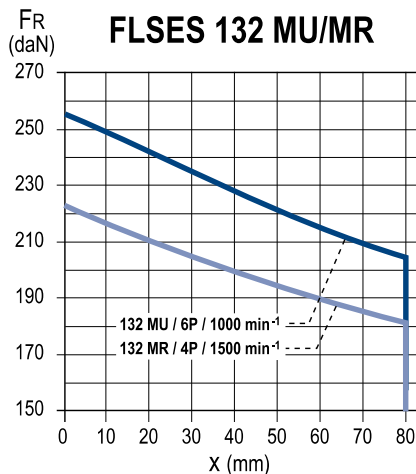
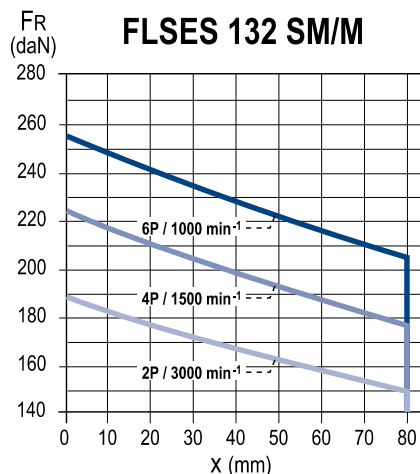
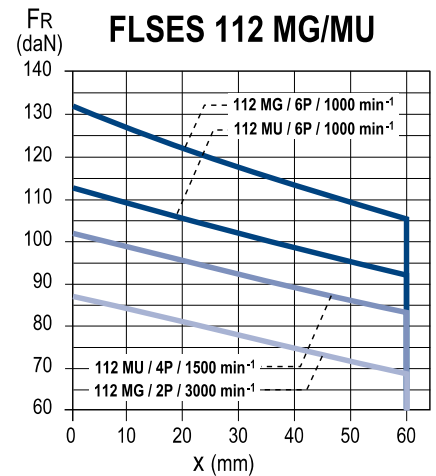
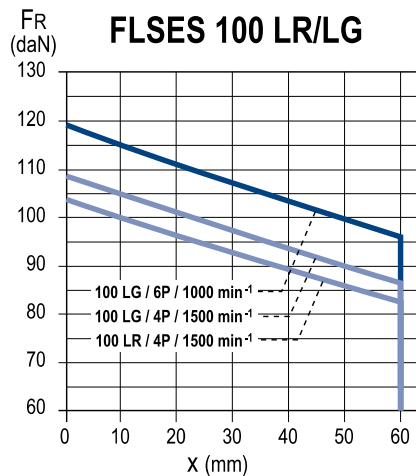
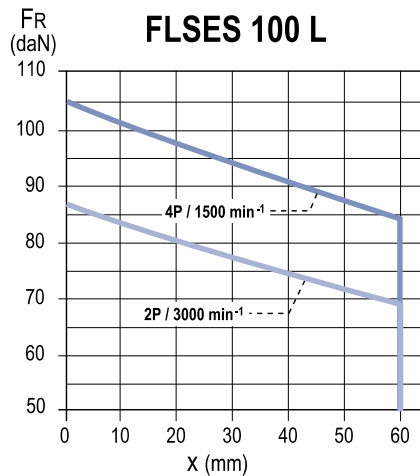
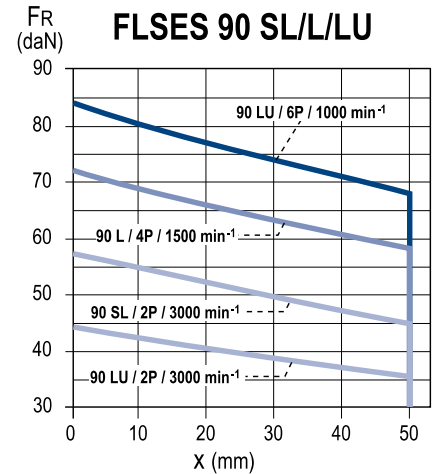
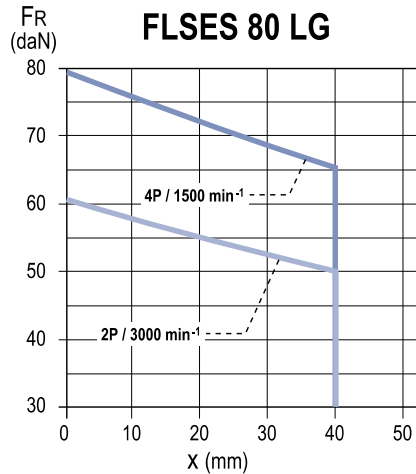
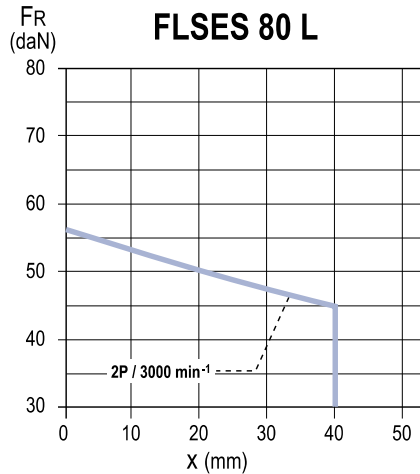

IP55 CAST IRON MOTORS

STANDARD FITTING ARRANGEMENT

Permissible radial load on main shaft extension with a bearing life L_{10h} of 25,000 hours.

FR : Radial Force

X: Distance with respect to the shaft shoulder

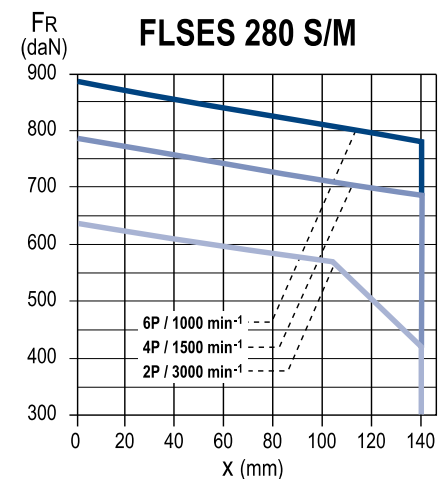
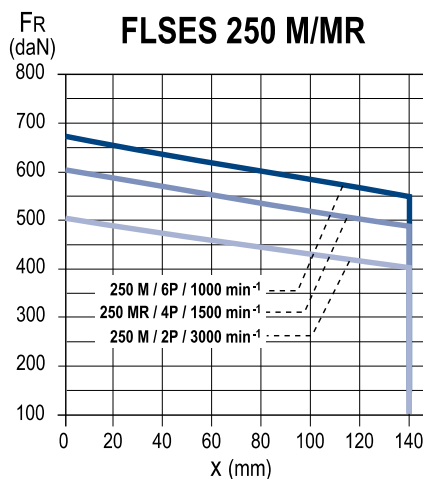
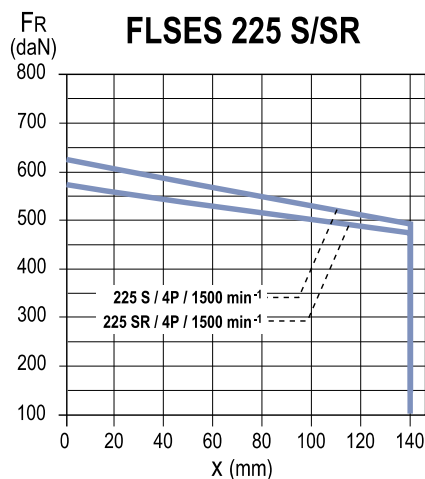
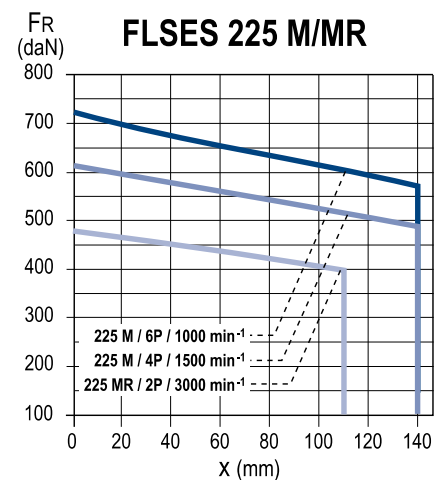
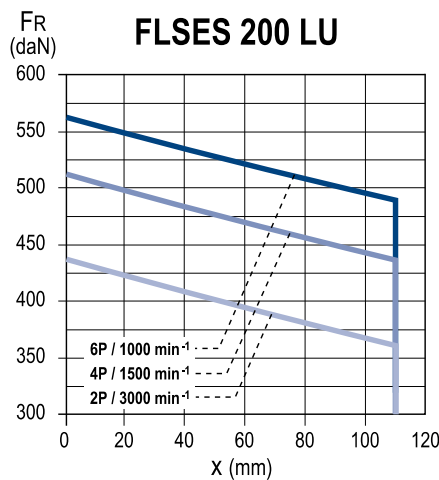
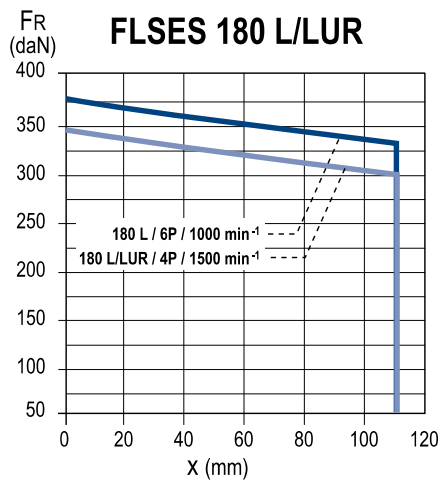
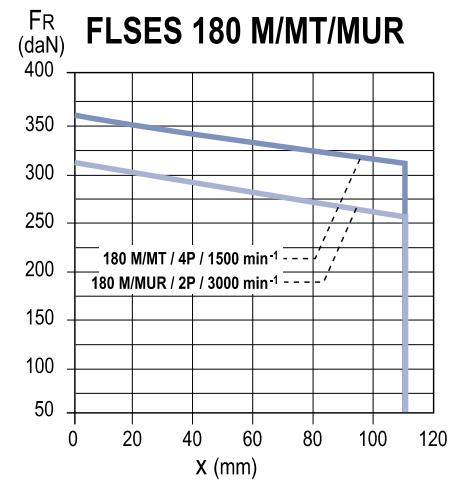
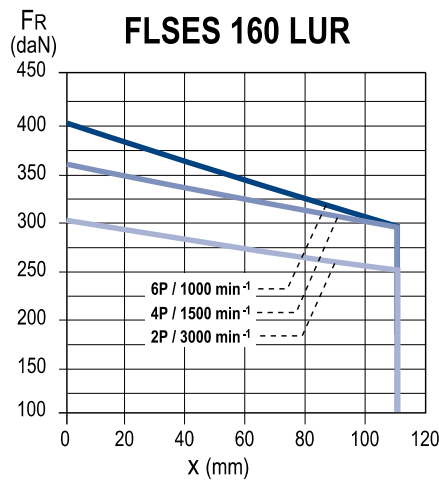
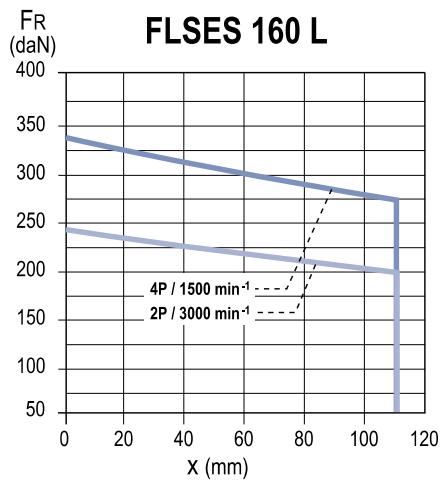

STANDARD FITTING ARRANGEMENT

Permissible radial load on main shaft extension with a bearing life L_{10h} of 25,000 hours.

FR : Radial Force

X: Distance with respect to the shaft shoulder

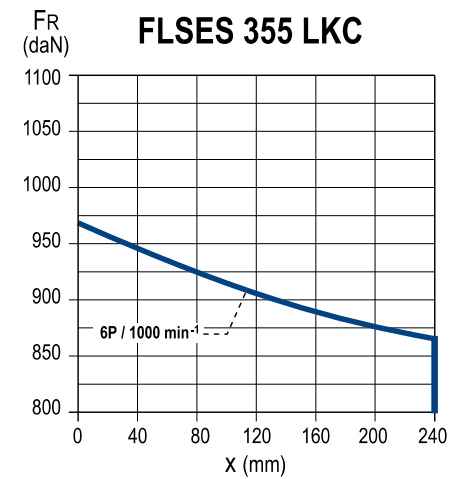
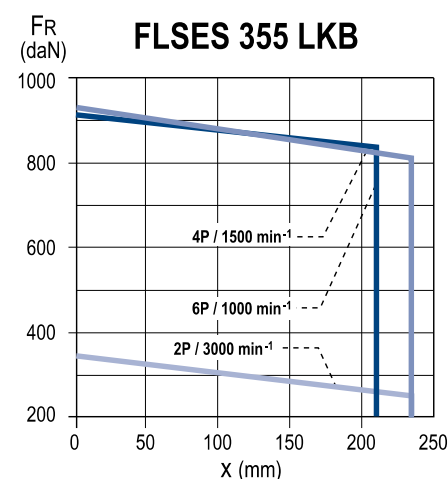
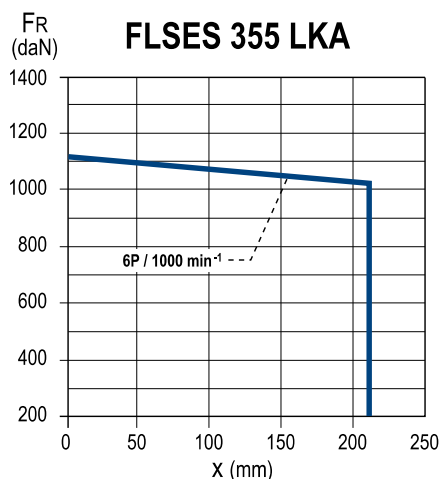
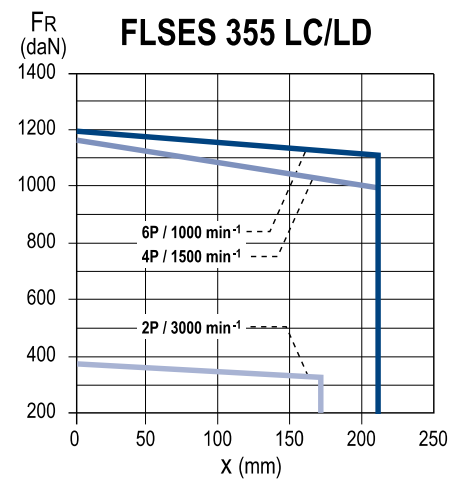
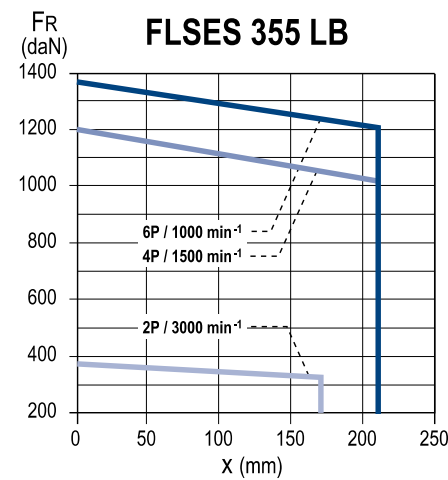
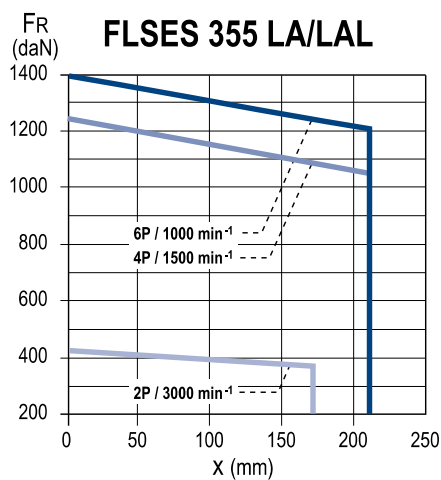
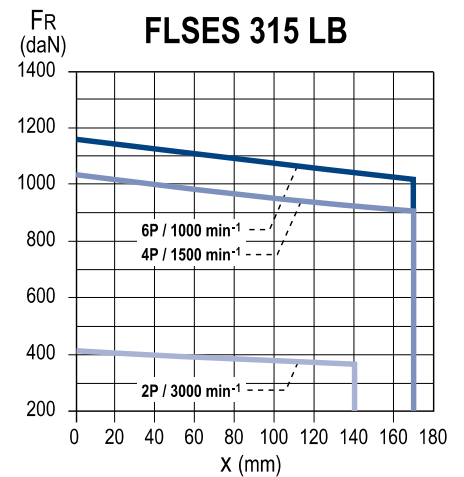
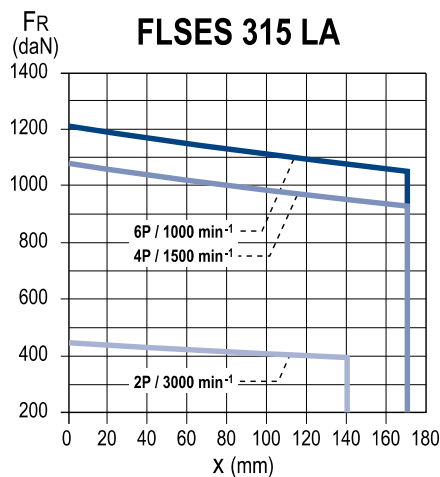
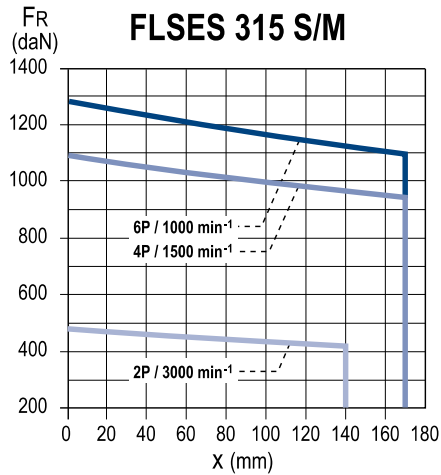

IMfinity® 3-phase induction motors - IE2 - IE3 - IE4 - Non IE Efficiency

IP55 Cast Iron frame

Construction

Radial loads

STANDARD FITTING ARRANGEMENT

Permissible radial load on main shaft extension with a bearing life L_{10h} of 25,000 hours.

FR : Radial Force

X: Distance with respect to the shaft shoulder

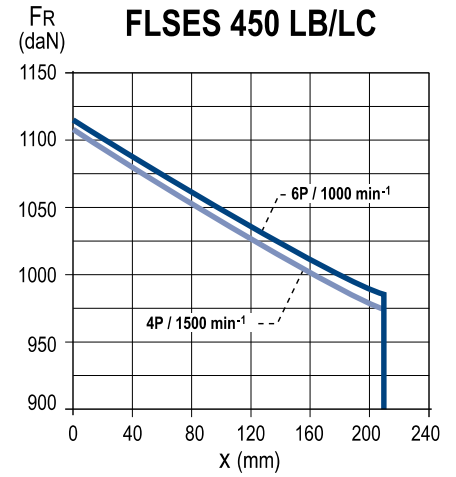
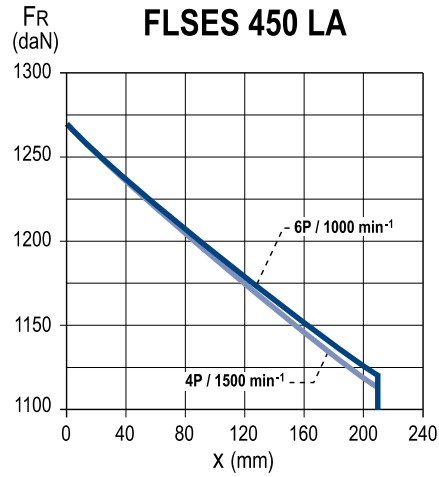
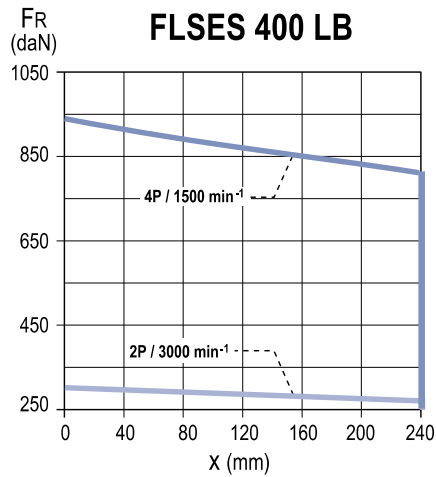

IMfinity® 3-phase induction motors - IE2 - IE3 - IE4 - Non IE Efficiency

IP55 Cast Iron frame

Construction

Radial loads

SPECIAL FITTING ARRANGEMENT

Type of drive end roller bearings

Series	Type	No. of poles	Non drive end bearing (N.D.E.)	Drive end bearing (D.E.)
FLSES	160 M/MU	4; 6	6210 C3	NU 309
	160 L	4		
	160 LUR	6	6210 C3	NU 310
	180 MT	4		
	180 M	4	6212 C3	NU 310
	180 L	4; 6		
	180 LUR	4; 6	6312 C3	NU 310
	200 LU	4; 6		
	225 S	4	6314 C3	NU 314
	225 SR	4		
	225 M	4; 6	6314 C3	NU 314
	225 MR	2		
	250 M	6	6314 C3	NU 314
	250 MR	4		
	280 S/M	4; 6	6314 C3	NU 316
	315 S/M/L	4; 6		
	355 L	4; 6	6316 C3	NU 322
	355 LKA	6		
	355 LKB	2	6317 C4	-
	355 LKB	4; 6		
	355 LKC	6	6324 C3	NU 324
	400 LB	2		
	400 LB	4; 6	6324 C3	NU 324
	450 LA	4		
	450 LA	6	6328 C3	NU 328
	450 LB	4		
	450 LB	6		
	450 LC	6		
450 LD	4			

IP55 CAST IRON MOTORS

Permissible radial load on main shaft extension with a bearing life L_{10h} of 25,000 hours.

FR : Radial Force

X: Distance with respect to the shaft shoulder

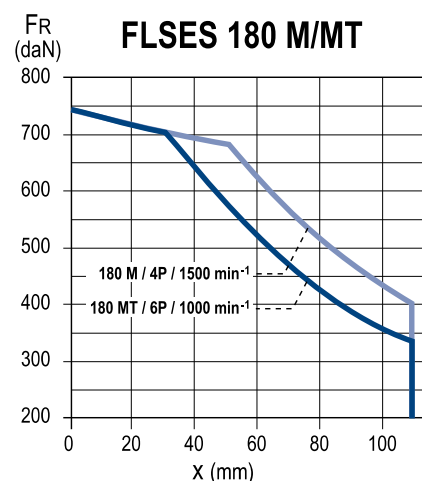
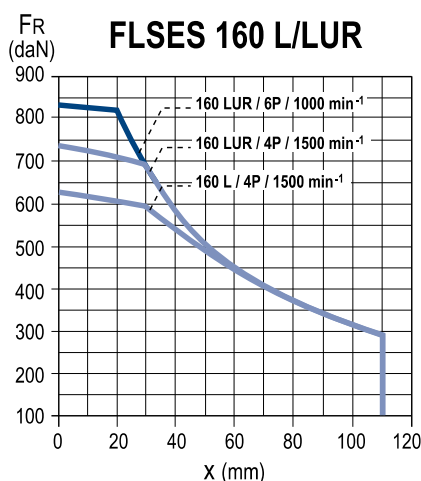
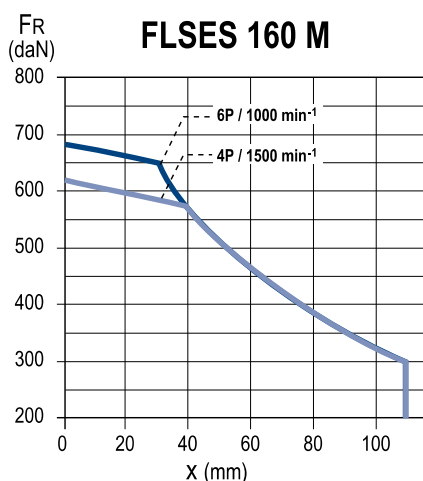

SPECIAL FITTING ARRANGEMENT

Permissible radial load on main shaft extension with a bearing life L_{10h} of 25,000 hours.

FR : Radial Force

X: Distance with respect to the shaft shoulder

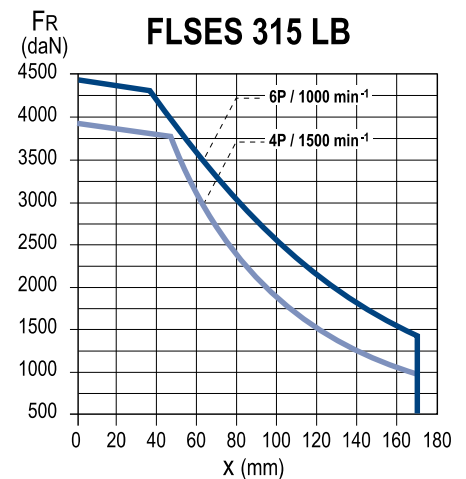
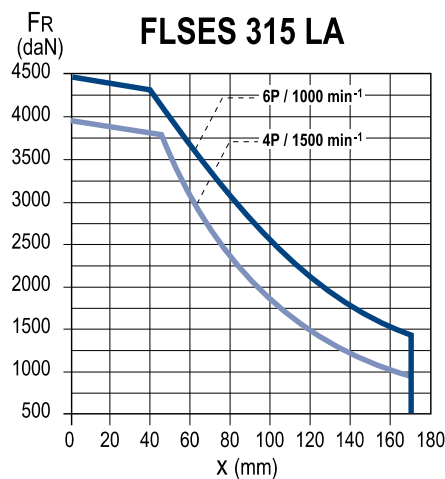
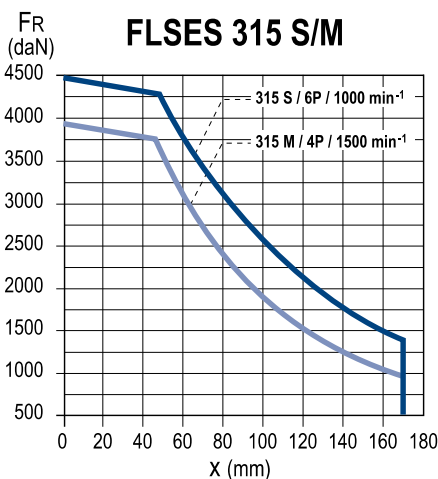
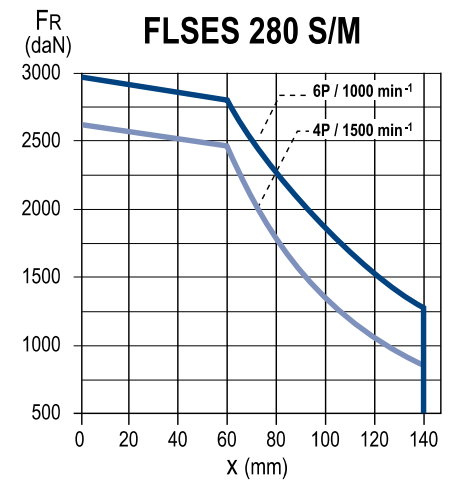
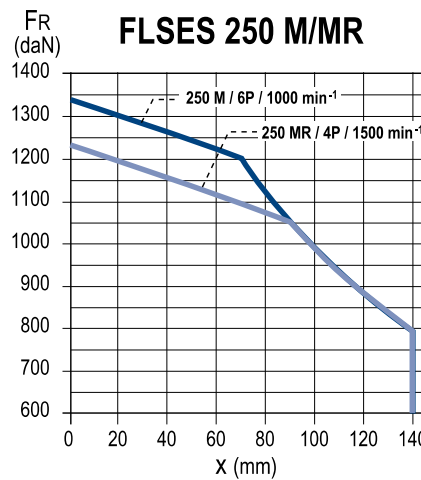
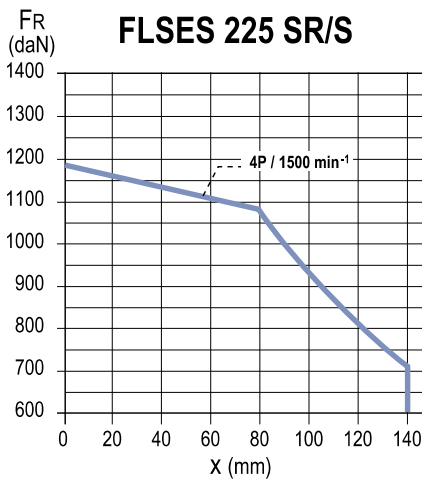
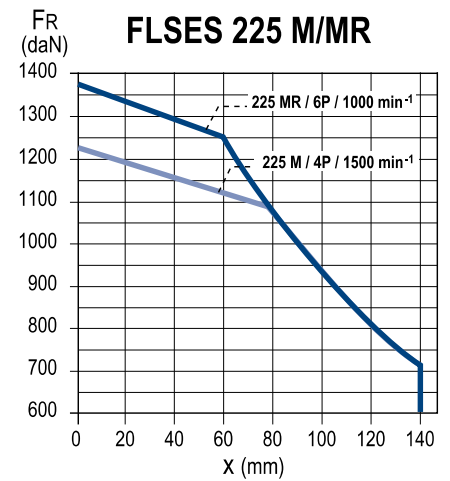
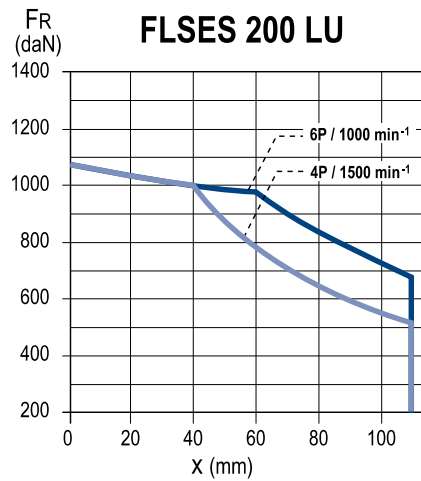
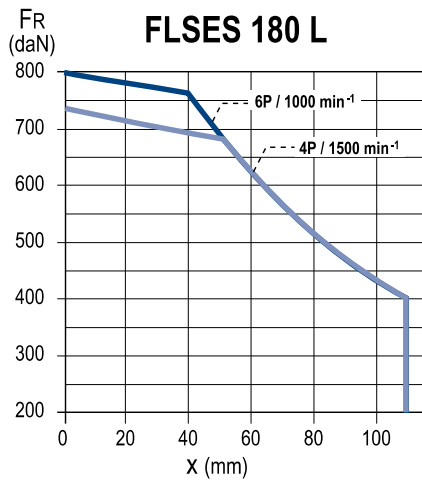

IMfinity® 3-phase induction motors - IE2 - IE3 - IE4 - Non IE Efficiency

IP55 Cast Iron frame

Construction

Radial loads

SPECIAL FITTING ARRANGEMENT

Permissible radial load on main shaft extension with a bearing life L_{10h} of 25,000 hours.

FR : Radial Force

X: Distance with respect to the shaft shoulder

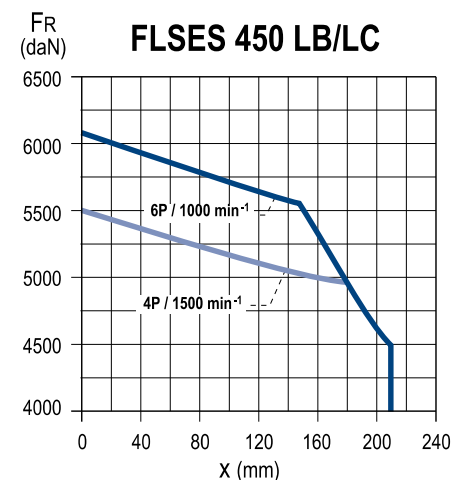
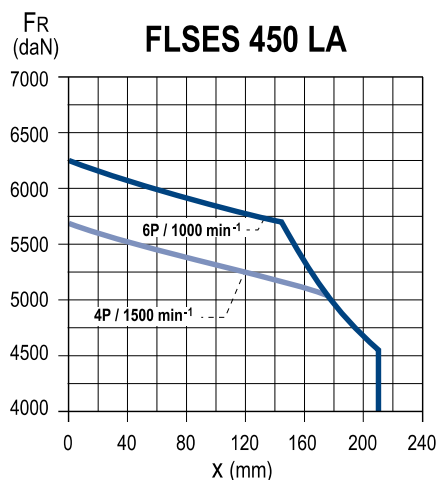
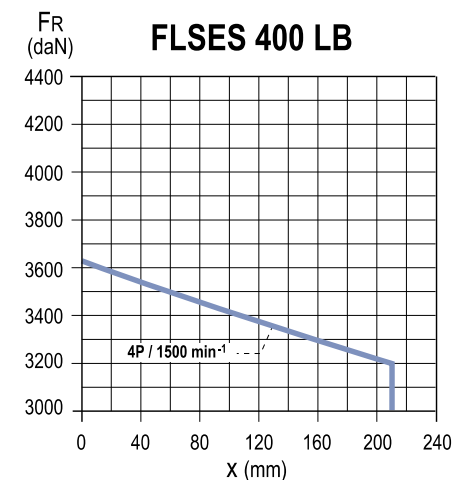
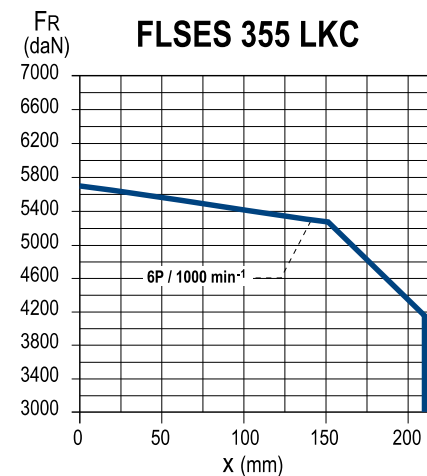
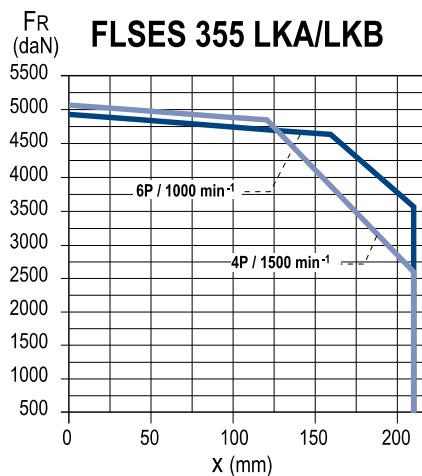
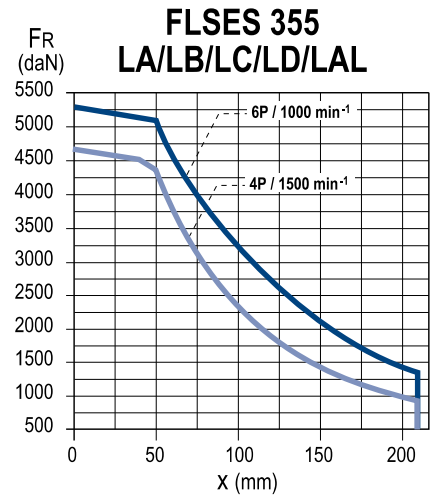
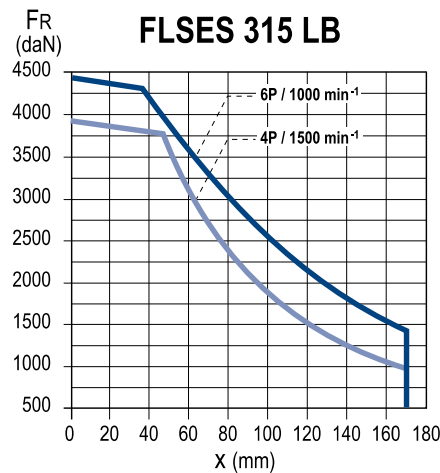
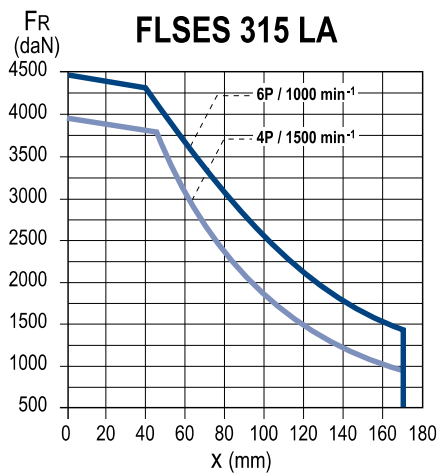

IP55 CAST IRON MOTORS

IMfinity® 3-phase induction motors - IE2 - IE3 - IE4 - Non IE Efficiency

IP55 Cast Iron frame

Optional features

Non-standard flanges

Optionally, Leroy-Somer motors can be fitted with flanges and faceplates that are larger or smaller than standard. This means that motors can be adapted to all types of situation without the need for costly and time-consuming modifications.

The tables below give the flange and faceplate dimensions and also indicate flange/motor compatibility.

The bearing and shaft extension for each frame size remain standard.

Dimensions in millimetres

(FF) Flange mounted

Symbol IEC	Flange dimensions						
	M	N	P	T	n	S	LA
FF 115	115	95	140	3	4	10	10
FF 130	130	110	160	3.5	4	10	10
FF 165	165	130	200	3.5	4	12	10
FF 215	215	180	250	4	4	15	12
FF 265	265	230	300	4	4	15	14
FF 300	300	250	350	5	4	18.5	14
FF 350	350	300	400	5	4	18.5	15
FF 400	400	350	450	5	8	18.5	16
FF 500	500	450	550	5	8	18.5	18**
FF 600	600	550*	660	6	8	24	22
FF 740	740	680*	800	6	8	24	22
FF 940	940	880*	1000	6	8	28	28
FF 1080	1080	1000*	1150	6	8	28	30

* Tolerance N js6

** LA = 22 for frame size ≥ 280

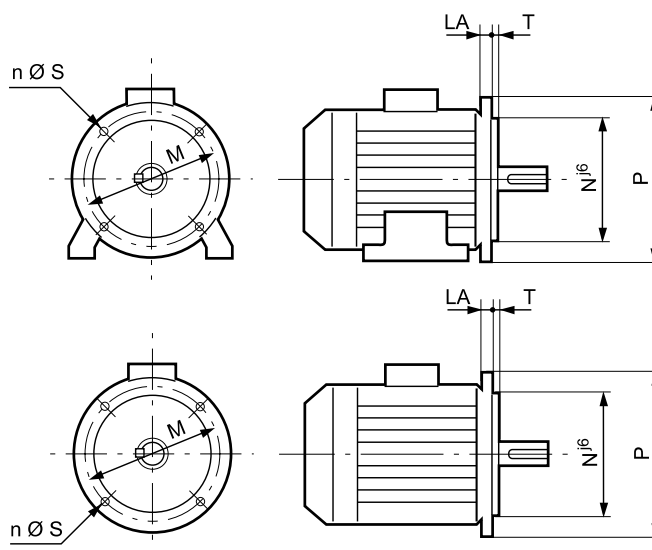

(FT) Face mounted

Symbol IEC	Faceplate dimensions					
	M	N	P	T	n	M.S
FT 85	85	70	105	2.5	4	M6
FT 100	100	80	120	3	4	M6
FT 115	115	95	140	3	4	M8
FT 130	130	110	160	3.5	4	M8
FT 165	165	130	200	3.5	4	M10
FT 215	215	180	250	4	4	M12
FT 265	265	230	300	4	4	M12

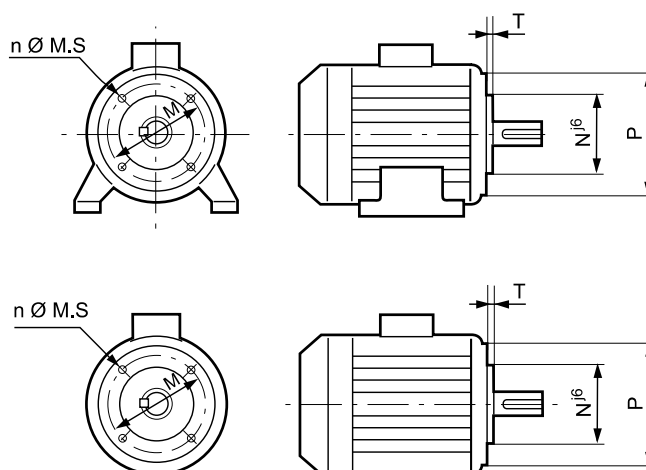

IMfinity® 3-phase induction motors - IE2 - IE3 - IE4 - Non IE Efficiency

IP55 Cast Iron frame

Optional features

Mechanical and electrical options

BRAKE MOTORS, FORCED VENTILATION

The integration of high-efficiency motors within a process often requires accessories to make operation easier:

- Forced ventilation for motors used at high or low speeds.

- Holding brakes for maintaining the rotor in the stop position without needing to leave the motor switched on.
- Emergency stop brakes to immobilise loads in case of failure of the motor torque control or loss of power supply.

Notes:

- Without forced ventilation, there is a possibility of overspeed with optional class B balancing.
- The motor temperature is monitored by sensors built into the windings.

FLSES series	LB dimensions with Forced Ventilation	
	Foot or face mounted motors	Flange mounted motor
80 L	317	
80 LG		
90 S	331	353
90 L		
90 LU		
100 L	373	
100 LK	422	
112 MG		
112 MU	412	
132 S		
132 MR	458	
132 M		
132 MU		
160 M		
160 L	641	
160 LU	702	
180 MR	641	
180 M		
180 L	689	
180 LUR		
200 LU	819	
225 SR		
225 MR	825,5	
225 M		
250 M	917	
280 S		
280 M	1167	
315 S		
315 M	1477	
315 LA/LB		
355 LA/LB/LC/LD/LAL	1668	
355 LKA/LKB	1995	
400		
450	Consult Leroy-Somer	

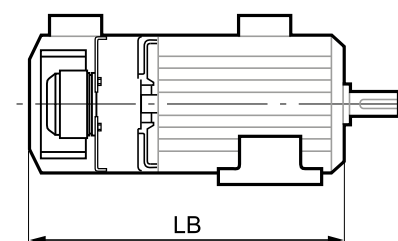

IP55 CAST IRON MOTORS

MOTORS WITH SPACE HEATERS

Type	Power (W)
FLSES 80 L	16
FLSES 80 LG to 132	25
FLSES 160 to 200	52
FLSES 225 SR/MR	
FLSES 225 M	84
FLSES 250 M	
FLSES 280 to 315	100*
FLSES 355 to 450	150*

* It is possible to increase the power when asking for estimate (quotation).

The space heaters use 200/240 V single phase, 50 or 60 Hz.

IMfinity® 3-phase induction motors - IE2 - IE3 - IE4 - Non IE Efficiency

IP55 Cast Iron frame

Installation and maintenance

Position of the lifting rings

LIFTING THE MOTOR ONLY (not coupled to the machine)

The regulations stipulate that over 25 kg, suitable handling equipment must be used.

All our motors are fitted with grab handles, making them easier to handle without risk. A diagram of the sling hoisting method appears below with the required dimensions.

To prevent any damage to the motor during handling (for example: switching the motor from horizontal to vertical), it is essential to follow these instructions.

HORIZONTAL POSITION

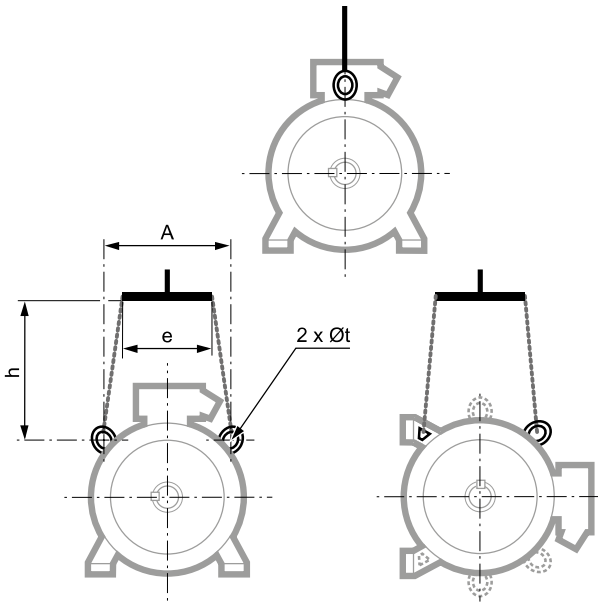

Type	Horizontal position			
	A	e min	h min	Øt
FLSES 100	152	200	150	22
FLSES 100 LG	145	200	150	22
FLSES 112	145	200	150	22
FLSES 132	180	200	150	25
FLSES 160 M/MU	200	260	150	14
FLSES 180 M/MUR/L/LUR	200	260	150	14
FLSES 200 LU	270	260	150	14
FLSES 225 SR/MR	270	260	150	14
FLSES 225 S/M	360	380	200	30
FLSES 250 M/MR	360	380	200	30
FLSES 280	360	380	500	30
FLSES 315 S/M/LA/LB	440	400	500	60
FLSES 355	545	500	500	60
FLSES 355 LK	685	710	500	30
FLSES 400	735	710	500	30
FLSES 450	730	710	500	30

VERTICAL POSITION

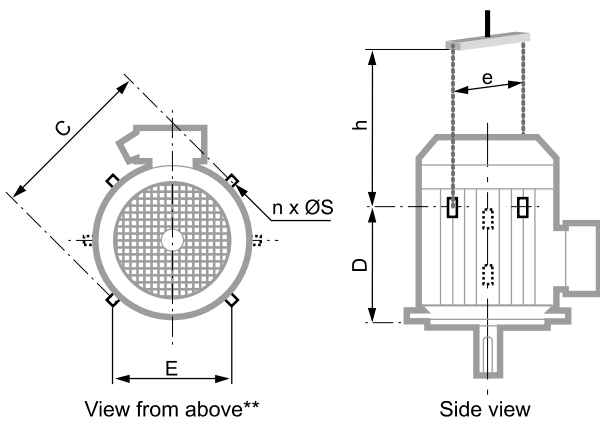

Type	Vertical position						
	C	E	D	n**	ØS	e mini*	h min
FLSES 160 M/MU	320	200	230	2	14	320	350
FLSES 180 M/MUR/L/LUR*	320	200	230	2	14	320	270
FLSES 200 LU	410	300	295	2	14	410	450
FLSES 225 SR/MR	410	300	295	2	14	410	450
FLSES 225 S/M	480	360	405	4	30	540	350
FLSES 250 M/MR	480	360	405	4	30	590	550
FLSES 280 S	480	360	585	4	30	590	550
FLSES 280 M	480	360	585	4	30	590	550
FLSES 315 S/M/LA/LB	620	-	715	2	35	650	550
FLSES 355	760	-	750	2	35	800	550
FLSES 355 LK	810	350	1135	4	30	810	600
FLSES 400	810	350	1135	4	30	810	600
FLSES 450	960	400	1170	4	30	960	750

Separate ring ≤ 25 kg
Built-in ring ≤ 25 kg

* if the motor is fitted with a drip cover, allow an additional 50 to 100 mm to avoid damaging it when the load is swung.

** if n = 2, the lifting rings form an angle of 90° with respect to the terminal box axis. If n = 4, this angle becomes 45°.

IMfinity® 3-phase induction motors - IE2 - IE3 - IE4 - Non IE Efficiency IP23 Aluminium or Steel frame

Contents

GENERAL INFORMATION	136-137
Designation.....	136
Description.....	137
ELECTRICAL AND MECHANICAL DATA	138 to 144
IE2 powered by the mains.....	138
IE2 powered by the drive.....	139
IE3 powered by the mains.....	140-141
IE3 powered by the drive.....	142-143
Mains connection.....	144
DIMENSIONS.....	145 to 148
Shaft extensions	145
Foot mounted IM 1001 (IM B3).....	146
Foot and flange mounted IM 2001 (IM B35)	147
Flange mounted IM 3001 (IM B5) IM 3011 (IM V1).....	148
CONSTRUCTION.....	149 to 157
Bearings and lubrication	149
Axial loads	150 to 152
Radial loads	153 to 157
OPTIONAL FEATURES	158
Mechanical options	158
Mechanical and electrical options	158
INSTALLATION AND MAINTENANCE.....	159
Position of the lifting rings	159

IMfinity® 3-phase induction motors - IE2 - IE3 - IE4 - Non IE Efficiency

IP23 Aluminium or Steel frame

General information

Designation



IP 23
Cl. F - ΔT 80 K

The complete motor **reference** described below will enable you to **order** the desired equipment.

The selection method consists of following the terms in the designation.

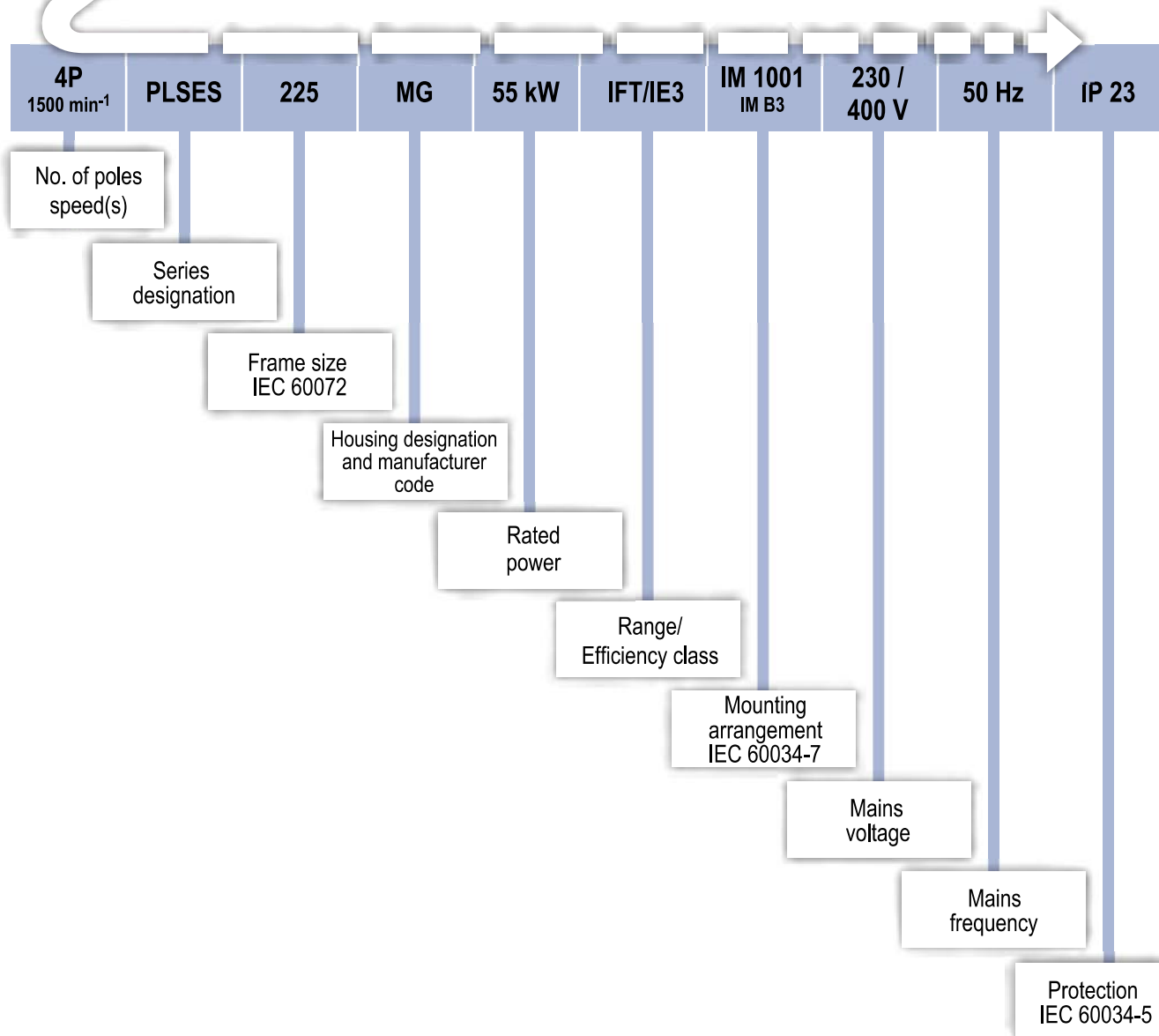

IMfinity® 3-phase induction motors - IE2 - IE3 - IE4 - Non IE Efficiency

IP23 Aluminium or Steel frame

General information

Description

Component	Materials	Remarks
Housing	Steel	<ul style="list-style-type: none"> - aluminium: frame size 180 to 200, 250 SP/MP - steel: frame size 225 to 400 except 250 SP/MP - gravity or low pressure die casting, frame size \leq 250 - lifting rings
Stator	Insulated low-carbon magnetic steel laminations Electroplated copper	<ul style="list-style-type: none"> - low carbon content guarantees long-term lamination pack stability - welded laminations - semi-enclosed slots - class F insulation
Rotor	Insulated low-carbon magnetic steel laminations Aluminium or copper	<ul style="list-style-type: none"> - inclined cage bars - rotor cage pressure die-cast in aluminium - rotor cage shrink-fitted to shaft - rotor balanced dynamically, class A, 1/2 key
Shaft	Steel	
End shields	Cast iron or steel	
Bearings and lubrication		Standard mounting: <ul style="list-style-type: none"> - ball bearings C3 play - permanently greased bearings for frame size \leq 200 - regreasable bearings from frame size 225 upwards - bearings preloaded at non drive end
Labyrinth seal Lipseals	Plastic or steel Synthetic rubber	- lipseal at drive end for all motors
Fan	Composite Aluminium or steel alloy	<ul style="list-style-type: none"> - bidirectional fan in motors with 2 poles ($P \leq$ 250 kW), 4 poles for frame size 180 to 315 except 315 MGU and LG - unidirectional fan (direction of rotation to be specified at time of ordering) in motors with 2 poles, for frame size 315 MGU and LG
Fan cover	Pressed steel	- fitted, on request, with a drip cover for operation in vertical position, shaft end facing up
Terminal box	Composite Aluminium alloy or steel	<ul style="list-style-type: none"> - can be turned in 4 directions, opposite the feet - fitted as standard with a terminal block with 6 steel terminals - terminal box comes fitted with threaded plugs for frame size \leq 280 SD/MD, for motors 280 MG to 315 and larger sizes, terminal box comes complete with a removable undrilled cable gland support plate, without cable gland - 1 earth terminal in each terminal box

In the standard version, the motors are wound 400 V 50 Hz with connection Δ

IMfinity® 3-phase induction motors - IE2 - IE3 - IE4 - Non IE Efficiency

IP23 Aluminium or Steel frame

Electrical and mechanical characteristics

IE2 powered by the mains

Type	Rated power P _n kW	Rated torque M _n N.m	Starting torque/ Rated torque M _d /M _n	Maximum torque/ Rated torque M _m /M _n	Starting current/ Rated current I _d /I _n	Moment of inertia J kg.m ²	Weight IM B3 kg	Noise LP db(A)	400V 50Hz							
									Rated speed N _n min ⁻¹	Rated current I _n A	Efficiency IEC 60034-2-1 2007			Power factor		
											4/4	3/4	2/4	4/4	3/4	2/4
2 poles																
PLSES 225 MG	75	241	2.3	2.9	7.5	0.335	365	85	2972	132	94.1	94.3	93.8	0.87	0.84	0.77
PLSES 250 SF	90	289	2.5	3.6	8.1	0.408	430	84	2972	156	94.4	94.7	94.4	0.88	0.86	0.80
PLSES 250 MF	110	353	2.9	3.7	8.9	0.479	465	85	2974	193	94.6	94.8	94.4	0.87	0.84	0.76
PLSES 280 MD	132	424	2.0	3.2	8.2	0.573	500	83	2974	225	95.0	95.4	95.3	0.89	0.86	0.80
PLSES 315 SU	160	513	2.3	3.1	7.7	1.050	700	80	2978	282	95.1	95.2	94.7	0.86	0.83	0.75
PLSES 315 M	200	641	2.2	3.3	7.1	1.120	720	84	2978	369	95.2	95.2	94.6	0.82	0.77	0.67
PLSES 315 L	250	803	2.2	2.9	6.9	1.260	790	85	2974	441	95.2	95.4	95.1	0.86	0.83	0.75
PLSES 315 LD	280	898	2.2	2.9	6.7	1.370	920	86	2976	493	95.4	95.4	94.8	0.86	0.83	0.76
PLSES 315 LD	315	1010	2.1	3.0	6.5	1.660	930	87	2976	561	95.3	95.5	95.2	0.85	0.82	0.75
4 poles																
PLSES 225 MG	55	354	2.1	2.9	7.0	0.648	375	76	1484	103	93.9	94.1	93.7	0.82	0.78	0.68
PLSES 250 SF	75	482	2.3	3.1	7.6	0.778	430	76	1486	143	94.2	94.4	94.0	0.80	0.78	0.67
PLSES 250 MF	90	579	2.4	3.1	7.9	0.956	495	77	1484	169	94.6	94.8	94.5	0.81	0.76	0.65
PLSES 280 SGJ	110	706	3.0	2.8	7.2	2.080	680	79	1488	202	94.7	94.7	94.0	0.83	0.79	0.69
PLSES 280 MG	132	847	2.5	2.8	7.3	2.290	715	80	1488	243	94.8	94.9	94.4	0.83	0.79	0.70
PLSES 315 SUR	160	1030	2.6	3.0	7.1	2.430	750	80	1488	300	95.0	95.0	94.4	0.81	0.76	0.64
PLSES 315 MU	200	1290	3.1	3.0	7.2	2.770	825	80	1486	374	95.1	95.1	94.1	0.81	0.75	0.64
PLSES 315 LUS	250	1610	2.8	2.8	6.6	3.240	925	85	1486	473	95.2	95.3	94.9	0.80	0.75	0.64
PLSES 315 LU	280	1800	2.4	2.2	5.9	3.440	960	83	1484	504	95.6	96.1	95.9	0.84	0.81	0.72

Type	Rated power P _n kW	380V 50Hz				415V 50Hz				460V 60Hz			
		Rated speed N _n min ⁻¹	Rated current I _n A	Efficiency η 4/4	Power factor Cos φ 4/4	Rated speed N _n min ⁻¹	Rated current I _n A	Efficiency η 4/4	Power factor Cos φ 4/4	Rated speed N _n min ⁻¹	Rated current I _n A	Efficiency η 4/4	Power factor Cos φ 4/4
		2 poles											
PLSES 225 MG	75	2968	138	93.8	0.88	2974	129	94.2	0.86	3576	116	93.8	0.87
PLSES 250 SF	90	2970	163	94.1	0.89	2974	152	94.5	0.87	3578	137	94.5	0.88
PLSES 250 MF	110	2974	199	94.3	0.89	2976	188	94.7	0.85	3580	168	94.6	0.87
PLSES 280 MD	132	2962	236	94.6	0.90	2972	219	95.2	0.88	3576	194	95.0	0.90
PLSES 315 SU	160	2978	292	94.8	0.88	2978	279	95.2	0.84	3582	246	95.1	0.85
PLSES 315 M	200	2974	377	95.0	0.85	2978	374	95.0	0.78	3582	325	95.4	0.81
PLSES 315 L	250	2970	458	95.1	0.87	2976	436	95.2	0.84	3578	382	95.5	0.86
PLSES 315 LD	280	2972	508	95.3	0.88	2978	488	95.3	0.84	3582	427	95.6	0.86
PLSES 315 LD	315	2972	576	95.3	0.87	2978	555	95.3	0.83	3582	486	95.7	0.85
4 poles													
PLSES 225 MG	55	1482	106	93.5	0.84	1486	101	94.1	0.80	1788	90.4	94.1	0.81
PLSES 250 SF	75	1482	147	94.0	0.82	1486	142	94.3	0.78	1786	125	94.5	0.80
PLSES 250 MF	90	1482	174	94.2	0.83	1486	168	94.5	0.79	1786	149	94.6	0.80
PLSES 280 SGJ	110	1486	207	94.6	0.85	1490	200	94.8	0.81	1790	178	94.7	0.82
PLSES 280 MG	132	1488	248	94.7	0.85	1488	240	94.9	0.81	1790	210	95.0	0.83
PLSES 315 SUR	160	1486	306	94.9	0.84	1488	299	95.0	0.78	1790	265	95.1	0.80
PLSES 315 MU	200	1486	379	95.1	0.84	1488	377	94.8	0.78	1790	329	95.4	0.80
PLSES 315 LUS	250	1484	480	95.2	0.83	1486	476	95.1	0.77	1790	412	95.6	0.80
PLSES 315 LU	280	1480	520	95.4	0.86	1484	497	95.8	0.82	1788	437	95.9	0.84

IP23 DRIP-PROOF MOTORS

IMfinity® 3-phase induction motors - IE2 - IE3 - IE4 - Non IE Efficiency

IP23 Aluminium or Steel frame

Electrical and mechanical characteristics

IE2 powered by the drive

Type	400V 50Hz				% Rated torque M_n at					400V 87Hz Δ^1				Maximum mechanical speed ²
	Rated power	Rated speed	Rated current	Power factor	10Hz	17Hz	25Hz	50Hz	87Hz	Rated power	Rated speed	Rated current	Power factor	
	P_n kW	N_n min ⁻¹	I_n A	Cos φ 4/4						P_n kW	N_n min ⁻¹	I_n A	Cos φ 4/4	
2 poles														
PLSES 225 MG	75	2968	139	0.89	70 %	85 %	98 %	100%	-	-	-	-	-	3600
PLSES 250 SF	90	2970	165	0.90	65 %	78 %	90 %	100%	-	-	-	-	-	3600
PLSES 250 MF	110	2974	202	0.89	65 %	78 %	90 %	100%	-	-	-	-	-	3600
PLSES 280 MD	122	2962	225	0.90	60 %	72 %	83 %	92 %	-	-	-	-	-	3600
PLSES 315 SU	160	2978	296	0.88	70 %	80 %	90 %	100%	-	-	-	-	-	3600
PLSES 315 M	200	2974	383	0.85	65 %	75 %	85 %	100%	-	-	-	-	-	3600
PLSES 315 L	230	2970	428	0.87	51 %	64 %	74 %	92 %	-	-	-	-	-	3600
PLSES 315 LD	250	2972	463	0.88	58 %	67 %	72 %	89 %	-	-	-	-	-	3600
PLSES 315 LD	280	2972	520	0.87	58 %	62 %	71 %	89 %	-	-	-	-	-	3600
4 poles														
PLSES 225 MG	55	1482	110	0.84	70 %	90 %	100%	100%	57 %	95.70	2592	190.55	0.84	3240
PLSES 250 SF	75	1482	151	0.82	66 %	80 %	90 %	100%	57 %	130.50	2592	262.68	0.82	3240
PLSES 250 MF	90	1482	181	0.82	61 %	70 %	83 %	100%	57 %	156.60	2592	314.25	0.82	3240
PLSES 280 SGJ	110	1486	214	0.85	80 %	100%	100%	100%	57 %	191.40	2596	371.72	0.85	2700
PLSES 280 MG	132	1488	253	0.85	80 %	97 %	100%	100%	57 %	229.68	2598	440.48	0.85	2700
PLSES 315 SUR	160	1486	314	0.83	75 %	84 %	95 %	100%	57 %	278.40	2596	546.94	0.83	3420
PLSES 315 MU	200	1486	389	0.84	72 %	84 %	95 %	100%	57 %	348.00	2596	677.00	0.84	3420
PLSES 315 LUS	250	1484	490	0.83	70 %	80 %	90 %	100%	57 %	435.00	2594	852.00	0.83	3420
PLSES 315 LU	260	1480	498	0.86	65 %	74 %	84 %	93 %	57 %	452.49	2590	866.01	0.86	2610

(1) Data only valid for: 400V 50Hz Y motors and frame size ≤ 250 mm

(2) See Vibrations section on page 48

IMfinity® 3-phase induction motors - IE2 - IE3 - IE4 - Non IE Efficiency

IP23 Aluminium or Steel frame

Electrical and mechanical characteristics

IE3 powered by the mains

Type	Rated power P _n kW	Rated torque M _n N.m	Starting torque/ Rated torque M _d /M _n	Maximum torque/ Rated torque M _m /M _n	Starting current/ Rated current I _d /I _n	Moment of inertia J kg.m ²	Weight IMB3 kg	Noise LP db(A)	400V 50Hz							
									Rated speed N _n min ⁻¹	Rated current I _n A	Efficiency IEC 60034-2-1 2007			Power factor		
											4/4	3/4	2/4	4/4	3/4	2/4
2 poles																
PLSES 225 MG	75	241	2.3	3.2	8.1	0.4114	405	83	2972	126	95.2	95.3	94.8	0.90	0.88	0.82
PLSES 250 SF	90	289	2.6	3.5	9.0	0.4827	450	84	2974	151	95.4	95.5	95.1	0.90	0.88	0.82
PLSES 250 MF	110	354	2.4	3.0	8.2	0.5594	490	84	2968	185	95.5	95.9	95.8	0.90	0.88	0.84
PLSES 280 MD	132	424	2.1	3.4	8.6	0.5733	500	83	2972	221	95.6	95.8	95.7	0.87	0.84	0.77
PLSES 315 SU	160	514	2.0	2.9	7.2	1.1217	710	79	2974	275	95.8	96.0	95.8	0.88	0.86	0.80
PLSES 315 MU	200	643	1.7	2.4	6.2	1.267	792	84	2970	334	96.0	96.4	96.4	0.90	0.89	0.85
PLSES 315 L	250	804	1.8	2.6	6.5	1.3899	850	84	2968	421	96.1	96.5	96.4	0.89	0.88	0.83
PLSES 315 LD	280	900	2.1	2.9	6.7	1.6605	930	86	2972	471	96.3	96.4	96.1	0.89	0.87	0.82
PLSES 315 MGU	315	1012	1.6	2.3	5.8	2.47	1082	81	2971	533	95.8	96.3	96.4	0.89	0.89	0.88
PLSES 315 LG	355	1139	1.8	2.7	6.8	2.76	1160	83	2977	605	96.3	96.7	96.5	0.88	0.87	0.83
PLSES 315 LG	400	1282	1.8	2.73	6.65	3.1	1250	80	2980	674	96.3	96.7	96.5	0.89	0.88	0.85
PLSES 315 VLG	450	1441	1.86	2.78	7.20	3.5	1340	80	2982	762	96.2	96.4	96.0	0.88	0.87	0.82
PLSES 315 VLGU	500	1605	1.66	2.70	6.29	3.5	1385	83	2975	862	96.2	96.2	94.6	0.87	0.86	0.75
PLSES 355 LA	560	1795	1.0	2.2	5.3	6.3	1860	92	2980	953	96.4	96.3	96.4	0.88	0.87	0.82
PLSES 355 LB	630	2014	2.0	3.86	9.2	8.4	2050	92	2988	1082	96.6	96.7	96.6	0.87	0.86	0.81
PLSES 355 LC	710	2271	1.73	3.36	8.2	8.9	2140	92	2986	1178	96.7	96.8	96.7	0.90	0.89	0.84
PLSES 450 LA	800	2554	2.17	3.4	9.0	19.5	3200	97	2992	1327	96.7	96.6	95.7	0.90	0.89	0.84
PLSES 450 LA	900	2874	1.93	3.02	8.0	19.5	3200	97	2991	1496	96.5	96.5	96.0	0.90	0.89	0.84
PLSES 450 LA	1000	3194	1.73	2.72	7.0	19.5	3200	97	2990	1662	96.5	96.5	96.2	0.90	0.89	0.84
PLSES 450 LB*	1120	3577	1.9	2.8	7.9	21	3400	97	2990	1078	96.6	96.6	96.0	0.90	0.89	0.84
PLSES 450 LB*	1250	3995	1.7	2.5	7.0	21	3400	97	2988	1204	96.5	96.5	96.1	0.90	0.89	0.84

(*) usable only on 690V - 50Hz mains
values provided for this voltage

4 poles																
PLSES 225 MG	55	354	2.2	2.7	7.2	0.7806	420	69	1484	100	94.8	95.2	95.0	0.83	0.79	0.71
PLSES 250 SF	75	483	2.3	3.2	8.0	0.9594	480	69	1484	137	95.0	95.2	94.7	0.83	0.78	0.69
PLSES 250 MF	90	578	2.6	3.1	8.3	1.0809	510	70	1486	166	95.5	95.7	95.3	0.82	0.76	0.65
PLSES 280 SGU	110	706	2.4	2.8	7.5	2.5287	765	80	1488	198	95.6	95.6	94.9	0.84	0.8	0.70
PLSES 280 MGU	132	847	3.1	2.8	7.4	2.8582	792	79	1488	236	95.8	95.9	95.5	0.84	0.8	0.70
PLSES 315 SUR	160	1030	2.8	2.9	7.6	2.8625	820	79	1488	290	96.1	96.2	95.6	0.82	0.78	0.67
PLSES 315 MUR	200	1290	2.9	2.9	7.4	3.3365	910	79	1486	361	96.2	96.4	96.0	0.83	0.78	0.68
PLSES 315 LUS	250	1610	3.0	2.9	7.4	3.5966	960	83	1486	450	96.2	96.4	95.9	0.83	0.79	0.70
PLSES 315 LG	280	1797	2.3	2.9	7.2	6.1	1170	83	1488	511	96.5	96.8	96.6	0.82	0.8	0.72
PLSES 315 LG	315	2024	2.0	2.5	6.6	6.1	1170	83	1486	555	96.4	96.7	96.5	0.85	0.82	0.74
PLSES 315 LG	355	2280	2.2	2.8	8.1	6.1	1170	83	1487	650	96.2	96.3	96.0	0.82	0.77	0.66
PLSES 315 VLG	400	2571	2.2	2.8	6.9	6.8	1327	83	1486	722	96.4	96.7	96.5	0.83	0.79	0.69
PLSES 315 VLGU	450	2890	2.7	3.0	7.6	7.3	1400	83	1487	822	96.4	96.6	95.1	0.82	0.79	0.69
PLSES 355 LA	500	3205	1.8	2.0	6.1	12	2150	86	1490	905	96.1	96.2	96.0	0.83	0.77	0.71
PLSES 355 LB	560	3597	1.63	1.76	5.4	12	2150	86	1487	1027	96.0	96.1	95.9	0.82	0.76	0.70
PLSES 355 LB	600	3848	2.27	2.46	7.1	12	2150	86	1489	1142	96.0	96.1	96.0	0.79	0.73	0.65
PLSES 400 LB	700	4484	1.9	1.71	6.0	25	3050	86	1491	1224	96.0	96.1	96.0	0.86	0.84	0.74
PLSES 400 LB	800	5117	2.57	2.21	7.8	25	3050	98	1493	1414	96.1	96.2	96.0	0.85	0.83	0.73
PLSES 400 LB	900	5761	2.4	2.08	7.2	25	3050	101	1492	1611	96.0	96.1	95.9	0.84	0.82	0.72

6 poles																
PLSES 355 LA	400	3871	1.5	2.40	6.1	13	1975	80	990	737	95.8	96.2	96.1	0.82	0.78	0.69
PLSES 355 LB	450	4323	1.76	2.97	7.3	18	2210	82	994	869	95.8	96.1	96.1	0.78	0.72	0.61
PLSES 400 LA	500	4808	2.0	2.43	6.4	38	3100	84	993	875	96.0	96.1	96.0	0.86	0.85	0.79
PLSES 400 LA	560	5391	1.77	2.16	5.7	38	3100	84	992	980	95.9	96.0	95.9	0.86	0.85	0.80
PLSES 400 LB	630	6059	2.0	2.38	6.29	38	3100	84	993	1113	96.1	96.2	96.1	0.85	0.84	0.79
PLSES 400 LD	710	6819	2.4	2.65	7.4	50	3300	84	994	1331	96.2	96.3	96.1	0.80	0.79	0.74

IMfinity® 3-phase induction motors - IE2 - IE3 - IE4 - Non IE Efficiency

IP23 Aluminium or Steel frame

Electrical and mechanical characteristics

IE3 powered by the mains

Type	Rated power	380V 50Hz				415V 50Hz				460V 60Hz			
		Rated speed	Rated current	Efficiency	Power factor	Rated speed	Rated current	Efficiency	Power factor	Rated speed	Rated current	Efficiency	Power factor
	P _n kW	N _n min ⁻¹	I _n A	η 4/4	Cos φ 4/4	N _n min ⁻¹	I _n A	η 4/4	Cos φ 4/4	N _n min ⁻¹	I _n A	η 4/4	Cos φ 4/4
2 poles													
PLSES 225 MG	75	2968	133	95.0	0.91	2974	123	95.3	0.89	3574	110	95.0	0.90
PLSES 250 SF	90	2968	158	95.1	0.91	2976	148	95.6	0.89	3576	132	95.3	0.90
PLSES 250 MF	110	2968	195	95.2	0.90	2972	178	95.8	0.89	3576	161	95.7	0.90
PLSES 280 MD	132	2974	227	95.4	0.88	2978	215	95.6	0.84	3578	192	95.7	0.87
PLSES 315 SU	160	2972	285	95.6	0.89	2978	268	95.9	0.87	3580	237	95.9	0.88
PLSES 315 MU	200	2966	352	95.8	0.90	2974	322	96.3	0.89	3576	289	96.3	0.90
PLSES 315 L	250	2964	443	95.8	0.90	2972	411	96.2	0.88	3576	364	96.5	0.89
PLSES 315 LD	280	2966	493	96.0	0.90	2974	459	96.4	0.88	3578	408	96.3	0.89
PLSES 315 MGU	315	2869	549	95.8	0.91	2980	520	95.8	0.88	3577	459	95.8	0.90
PLSES 315 LG	355	2974	619	95.8	0.91	2980	579	95.8	0.89	3577	517	95.8	0.90
PLSES 315 LG	400	2972	711	96.0	0.89	2980	656	96.4	0.88	3580	589	95.8	0.89
PLSES 315 VLG	450	2972	800	96.0	0.89	2981	738	96.4	0.88	3582	670	95.8	0.88
PLSES 315 VLGU	500	2972	901	95.8	0.88	2977	843	96.0	0.86	3575	753	95.8	0.87
PLSES 355 LA	560	2978	993	96.3	0.89	2981	928	96.5	0.87	3582	825	96.8	0.88
PLSES 355 LB	630	2987	1113	96.6	0.89	2989	1019	96.6	0.84	3589	929	96.7	0.88
PLSES 355 LC	710	2984	1227	96.6	0.91	2987	1161	96.7	0.88	3587	1022	96.9	0.90
PLSES 450 LA	800	2991	1397	96.7	0.90	2993	1293	96.7	0.89	3593	1153	96.8	0.90
PLSES 450 LA	900	2990	1557	96.5	0.91	2992	1426	96.5	0.89	3592	1284	96.7	0.91
PLSES 450 LA	1000	2989	1749	96.5	0.90	2991	1620	96.5	0.89	3591	1442	96.7	0.90

4 poles													
PLSES 225 MG	55	1480	105	94.6	0.84	1486	99.1	95.0	0.82	1790	89.7	95.4	0.81
PLSES 250 SF	75	1484	142	95.0	0.85	1488	136	95.1	0.81	1790	122	95.4	0.81
PLSES 250 MF	90	1484	171	95.3	0.84	1488	164	95.7	0.8	1790	145	95.6	0.81
PLSES 280 SGU	110	1488	206	95.4	0.85	1490	193	95.6	0.83	1790	174	95.8	0.83
PLSES 280 MGU	132	1486	247	95.6	0.85	1490	231	96.0	0.83	1790	205	96.2	0.84
PLSES 315 SUR	160	1488	300	95.8	0.85	1492	286	96.0	0.81	1790	253	96.2	0.82
PLSES 315 MUR	200	1484	371	96.0	0.85	1488	357	96.1	0.81	1790	317	96.3	0.82
PLSES 315 LUS	250	1484	466	96.0	0.85	1488	446	96.2	0.81	1790	398	96.4	0.82
PLSES 315 LG	280	1484	526	96.3	0.84	1485	504	96.6	0.80	1788	446	96.0	0.82
PLSES 315 LG	315	1484	573	96.0	0.87	1488	542	96.3	0.84	1787	484	96.2	0.85
PLSES 315 LG	355	1486	660	96.1	0.85	1489	651	96.0	0.79	1788	565	96.2	0.82
PLSES 315 VLG	400	1485	744	96.1	0.85	1489	713	96.4	0.81	1786	629	96.2	0.83
PLSES 315 VLGU	450	1485	846	96.2	0.84	1488	813	96.3	0.80	1787	716	96.2	0.82
PLSES 355 LA	500	1487	942	96.0	0.84	1491	882	96.2	0.82	1790	796	96.2	0.82
PLSES 355 LB	560	1486	1082	95.9	0.82	1488	989	96.1	0.82	1788	889	96.4	0.82
PLSES 355 LB	600	1488	1172	96.0	0.81	1489	1144	96.0	0.76	1790	978	96.3	0.80
PLSES 400 LB	700	1490	1275	95.9	0.87	1492	1180	96.0	0.86	1792	1061	96.3	0.86
PLSES 400 LB	800	1492	1472	96.0	0.86	1494	1397	96.0	0.83	1794	1228	96.2	0.85
PLSES 400 LB	900	1491	1656	96.0	0.86	1493	1591	96.0	0.82	1793	1398	96.2	0.84

6 poles													
PLSES 355 LA	400	988	759	95.4	0.84	992	716	96.0	0.81	1189	632	95.8	0.83
PLSES 355 LB	450	992	896	95.4	0.80	995	847	96.0	0.77	1192	747	95.8	0.79
PLSES 400 LA	500	992	921	95.9	0.86	994	843	96.0	0.86	1193	758	96.3	0.86
PLSES 400 LA	560	991	1014	95.8	0.86	993	955	96.0	0.86	1193	834	96.3	0.86
PLSES 400 LB	630	992	1187	96.0	0.86	994	1086	96.1	0.86	1194	1163	96.4	0.83
PLSES 400 LD	710	993	1369	96.1	0.82	996	1316	96.2	0.78	1195	1156	96.4	0.80

IP23 DRIP-PROOF MOTORS

IMfinity® 3-phase induction motors - IE2 - IE3 - IE4 - Non IE Efficiency

IP23 Aluminium or Steel frame

Electrical and mechanical characteristics

IE3 powered by the drive

Type	400V 50Hz				% Rated torque M_n at					400V 87Hz Δ^1				Maximum mechanical speed ²
	Rated power	Rated speed	Rated current	Power factor	10Hz	17Hz	25Hz	50Hz	87Hz	Rated power	Rated speed	Rated current	Power factor	
	P_n kW	N_n min ⁻¹	I_n A	Cos ϕ 4/4						P_n kW	N_n min ⁻¹	I_n A	Cos ϕ 4/4	
2 poles														
PLSES 225 MG	75	2968	138	0.90	77%	90%	100%	100%	-	-	-	-	-	3600
PLSES 250 SF	90	2968	164	0.90	77%	90%	100%	100%	-	-	-	-	-	3600
PLSES 250 MF	110	2968	198	0.91	77%	90%	100%	100%	-	-	-	-	-	3600
PLSES 280 MD	132	2966	239	0.91	77%	86%	96%	100%	-	-	-	-	-	3600
PLSES 315 SU	160	2972	293	0.88	80%	90%	100%	100%	-	-	-	-	-	3600
PLSES 315 MU	200	2966	366	0.90	70%	80%	85%	100%	-	-	-	-	-	3600
PLSES 315 L	211	2964	386	0.89	70%	80%	85%	85%	-	-	-	-	-	3600
PLSES 315 LD	248	2966	450	0.89	70%	80%	85%	88%	-	-	-	-	-	3600
PLSES 315 MGU	315	2972	583	0.90	75%	85%	100%	100%	-	-	-	-	-	3580
PLSES 315 LG	355	2977	648	0.90	75%	85%	100%	100%	-	-	-	-	-	3580
PLSES 315 LG	400	2977	734	0.88	75%	85%	100%	100%	-	-	-	-	-	3600
PLSES 315 VLG	450	2982	817	0.89	75%	85%	100%	100%	-	-	-	-	-	3600
PLSES 315 VLGU	500	2975	928	0.87	75%	85%	100%	100%	-	-	-	-	-	3600
PLSES 355 LA	560	2980	1029	0.89	80%	90%	100%	100%	-	-	-	-	-	3600
PLSES 355 LB	630	2988	1169	0.88	80%	90%	100%	100%	-	-	-	-	-	3600
PLSES 355 LC	710	2986	1272	0.91	80%	90%	100%	100%	-	-	-	-	-	3600
PLSES 450 LA	800	2992	1433	0.91	80%	90%	100%	100%	-	-	-	-	-	3600
PLSES 450 LA	900	2991	1616	0.91	80%	90%	100%	100%	-	-	-	-	-	3600
PLSES 450 LA	1000	2990	1796	0.91	80%	90%	100%	100%	-	-	-	-	-	3600
PLSES 450 LB*	1120	2990	1160	0.91	80%	90%	100%	100%	-	-	-	-	-	3000
PLSES 450 LB*	1250	2988	1296	0.91	80%	90%	100%	100%	-	-	-	-	-	3000

(*) usable only on 690V - 50Hz mains
values provided for this voltage

4 poles														
PLSES 225 MG	55	1478	112	0.83	65%	80%	90%	100%	57%	95.7	2588	194.79	0.83	3240
PLSES 250 SF	75	1480	155	0.83	65%	80%	90%	100%	57%	130.5	2590	269.84	0.83	3240
PLSES 250 MF	90	1482	186	0.82	65%	80%	90%	100%	57%	156.6	2592	323.45	0.82	3240
PLSES 280 SGU	110	1486	223	0.84	70%	80%	90%	100%	57%	191.4	2596	387.78	0.84	2700
PLSES 280 MGU	132	1484	266	0.84	70%	80%	90%	100%	57%	229.68	2594	462.84	0.84	2700
PLSES 315 SUR	160	1486	320	0.83	70%	80%	90%	100%	57%	278.4	2596	557.55	0.83	3420
PLSES 315 MUR	200	1482	396	0.83	70%	80%	90%	100%	57%	348	2592	689.79	0.83	3420
PLSES 315 LUS	250	1482	499	0.83	70%	80%	90%	100%	57%	435	2592	868.5	0.83	3420
PLSES 315 LG	280	1488	535	0.85	75%	83%	100%	100%	57%	280	2610	535	0.85	2610
PLSES 315 LG	315	1486	606	0.86	69%	75%	89%	100%	58%	315	2610	606	0.86	2610
PLSES 315 LG	355	1487	682	0.85	77%	84%	100%	100%	58%	355	2610	682	0.85	2610
PLSES 315 VLG	400	1486	754	0.85	75%	86%	100%	100%	58%	400	2610	754	0.85	2610
PLSES 315 VLGU	450	1487	850	0.86	70%	80%	100%	100%	58%	450	2600	850	0.86	2610
PLSES 355 LA	500	1490	974	0.84	80%	90%	100%	100%	-	-	-	-	-	1800
PLSES 355 LB	560	1487	1108	0.83	80%	90%	100%	100%	-	-	-	-	-	1800
PLSES 355 LB	600	1489	1232	0.80	80%	90%	100%	100%	-	-	-	-	-	1800
PLSES 400 LB	700	1491	1322	0.87	80%	90%	100%	100%	-	-	-	-	-	1800
PLSES 400 LB	800	1493	1526	0.86	80%	90%	100%	100%	-	-	-	-	-	1800
PLSES 400 LB	900	1492	1739	0.85	80%	90%	100%	100%	-	-	-	-	-	1800

6 poles														
PLSES 355 LA	400	990	789	0.83	80%	90%	100%	100%	-	-	-	-	-	1200
PLSES 355 LB	450	992	930	0.79	80%	90%	100%	100%	-	-	-	-	-	1200
PLSES 400 LA	500	993	936	0.87	80%	90%	100%	100%	-	-	-	-	-	1200
PLSES 400 LA	560	992	1031	0.87	80%	90%	100%	100%	-	-	-	-	-	1200
PLSES 400 LB	630	993	1140	0.86	80%	90%	100%	100%	-	-	-	-	-	1200
PLSES 400 LD	710	994	1360	0.81	80%	90%	100%	100%	-	-	-	-	-	1200

(1) Data only valid for: 400 V 50 Hz Y motors and frame size ≤ 250 mm - 2 poles
(2) See Vibrations section on page 48

 - Please refer to page 38 for variable speed applications
- Values given with a voltage drop of 30 V at the drive output

IMfinity® 3-phase induction motors - IE2 - IE3 - IE4 - Non IE Efficiency

IP23 Aluminium or Steel frame

Electrical and mechanical characteristics

IE3 powered by the drive

Summary of recommended protection devices

Mains voltage	Cable length	Frame size	Winding protection	Insulated bearings
≤ 480 V	< 20 m	All frame sizes	Standard	No
		≤ 315	Standard	No
	> 20 m and < 100 m	≥ 315	RIS or drive filter	NDE
> 480 V and ≤ 690 V	< 20 m	< 250	Standard	No
		≥ 250	RIS or drive filter	NDE
	> 20 m and < 100 m	≤ 250	RIS or drive filter	NDE
		≥ 250	RIS or drive filter	NDE
		≥ 250	RIS or drive filter	NDE (or DE+NDE if no filter for ≥ 315)

RIS: Reinforced Insulation System.

The filter is recommended above frame size 315.

Standard insulation = 1500 V peak and 3500 V/μs.

Protection solutions exist (insulation for winding and bearings).

For different cable length(s) and/or voltage(s), please consult Leroy-Somer.

Motors of frame size ≥ 250 kW with RIS protection are no longer cURus.



REMINDER: All 2, 4 and 6 pole motors placed on the EU market must be IE3 or IE2 and used with a variable speed drive:

- from 01/01/2015 for power ratings from 7.5 to 375 kW
- from 01/01/2017 for power ratings from 0.75 to 375 kW

Other drive mechanism solutions:



LSRPM / PLSRPM: permanent magnet synchronous motors 3 to 500 kW

Variable speed application, requiring IP55 or IP23 protection, high efficiency and/or compact dimensions.



CPLS: induction motors 95 to 2900 Nm

Application for variable speed operation requiring constant power over a wide speed range.



LSMV: induction motors 0.18 to 132 kW

Application for variable speed operation requiring constant torque over a wide speed range.



LSK: D.C. motors 2 to 750 kW



UNIMOTOR FM and HD: servomotors 0.7 to 136 Nm

IMfinity® 3-phase induction motors - IE2 - IE3 - IE4 - Non IE Efficiency

IP23 Aluminium or Steel frame

Electrical and mechanical characteristics

Mains connection

DESCRIPTION TABLE OF TERMINAL BOXES FOR A 400 V RATED SUPPLY VOLTAGE (in accordance with EN 50262)

Series	Type	No. of poles	Terminal box material	Power + auxiliaries	
				Number of drill holes	Drill hole diameter
PLSES	225	2; 4	Aluminium alloy	3	2xM63 + 1xM16
	250	2; 4			
	280 MD/SD	2; 4			
	280 SG/MG - 315 to 450	2; 4		0	Removable undrilled mounting plate (see details page 164)

TERMINAL BLOCKS DIRECTION OF ROTATION

Standard motors are fitted with a block of 6 terminals complying with standard NFC 51 120, with the terminal markings complying with IEC 60034-8 (or NF EN 60034-8).

When the motor is running in U1, V1, W1 or 1U, 1V, 1W from a direct mains supply L1, L2, L3, it turns clockwise when seen from the drive shaft end.

If any two of the phases are changed over, the motor will run in an anticlockwise direction (make sure that the motor has been designed to run in both directions). If the motor is fitted with accessories (thermal protection or space heater), these must be connected on screw dominos with labelled wires.

Tightening torque for the nuts on the terminal blocks.

Terminal	M8	M10	M12	M14	M16
Torque N.m	10	20	35	50	65

Series	Type	230/400V connections		400/690V connections
		No. of poles	Terminals	Terminals
PLSES	225 MG	4	M10	M8
	225 MG	2	M12	M10
	250 MF	2; 4	M12	M10
	280	2; 4	M16	M12
	315 SU/MU/SUR/MUR/M	4	M16	M12
	315 L/LD/LU/LUS	2; 4	M16	M16
	315 VLG/LG/MGU	2; 4	M12	M12
	315 VLGU	2; 4	M12	M12
	355	2; 4	M14	M14
	355 LA	2	M14	M14
	355 LA	6	M14	M14
	355 LB	2	M14	M14
	355 LB	4	M14	M14
	355 LB	6	M14	M14
	355 LC	2	M14	M14
	400	2; 4	M14	M14
	400 LA	6	M14	M14
	400 LB	4	M14	M14
	400 LB	6	M14	M14
	400 LD	6	M14	M14
	450 LA	2	M14	M14
	450 LB	2	M14	M14

IMfinity® 3-phase induction motors - IE2 - IE3 - IE4 - Non IE Efficiency IP23 Aluminium or Steel frame

Dimensions

Shaft extensions

Dimensions in millimetres

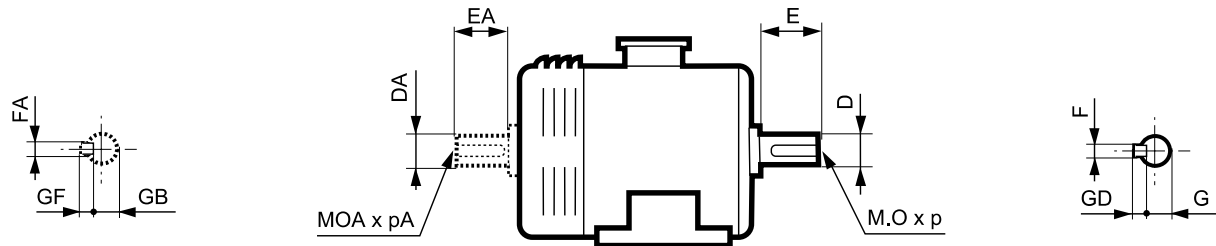

Type	Main shaft extensions													
	4 and 6 poles							2 poles						
	F	GD	D	G	E	O	p	F	GD	D	G	E	O	p
PLSES 225 MG	18	11	65m6	58	140	20	42	18	11	60m6	53	140	20	42
PLSES 250 MF	20	12	75m6	67.5	140	20	42	18	11	65m6	58	140	20	42
PLSES 250 SF	20	12	75m6	67.5	140	20	42	18	11	65m6	58	140	20	42
PLSES 280 MD/MGU/SGU/SGJ/MG	22	14	80m6	71	170	20	42	18	11	65m6	58	140	20	42
PLSES 315 S/SU/SUR/L/M/MUR	25	14	90m6	81	170	24	50	20	12	70m6	62.5	140	20	42
PLSES 315 LD	-	-	-	-	-	-	-	22	14	80m6	71	170	20	42
PLSES 315 LUS	25	14	90m6	81	170	24	50	-	-	-	-	-	-	-
PLSES 315 MU	25	14	90m6	81	170	24	50	20	12	70m6	62.5	140	20	42
PLSES 315 LG/MGU/LU	28	16	100m6	90	210	24	50	22	14	80m6	71	170	20	42
PLSES 315 VLG/VLGU	28	16	100m6	90	210	24	50	22	14	80m6	71	170	20	42
PLSES 355 LA	28	16	110m6	100	210	24	50	22	14	80m6	71	170	20	42
PLSES 355 LB	28	16	110m6	100	210	24	50	22	14	80m6	71	170	20	42
PLSES 355 LC	-	-	-	-	-	-	-	22	14	80m6	71	170	20	42
PLSES 400 LA	32	18	120m6	109	210	24	50	-	-	-	-	-	-	-
PLSES 400 LB	32	18	120m6	109	210	24	50	-	-	-	-	-	-	-
PLSES 400 LD	32	18	120m6	109	210	24	50	-	-	-	-	-	-	-
PLSES 450 LA	-	-	-	-	-	-	-	22	14	85m6	76	170	20	42
PLSES 450 LB	-	-	-	-	-	-	-	22	14	85m6	76	170	20	42

Type	Secondary shaft extensions													
	4 and 6 poles							2 poles						
	FA	GF	DA	GB	EA	OA	pA	FA	GF	DA	GB	EA	OA	pA
PLSES 225 MG	18	11	65m6	58	140	20	42	18	11	60m6	53	140	20	42
PLSES 250 MF	20	12	65m6	58	140	20	42	18	11	65m6	58	140	20	42
PLSES 250 SF	18	11	65m6	58	140	20	42	18	11	65m6	58	140	20	42
PLSES 280 MG	18	11	65m6	58	140	20	42	-	-	-	-	-	-	-
PLSES 280 MD/MGU/SGU/SGJ	20	12	65m6	58	140	20	42	18	11	65m6	58	140	20	42
PLSES 315 S/SU/SUR/L/LD/M/MUR	20	12	75m6	67.5	140	20	42	18	11	70m6	62.5	140	20	42
PLSES 315 LUS	20	12	75m6	67.5	140	20	42	18	11	70m6	62.5	140	20	42
PLSES 315 MU	20	12	75m6	67.5	140	20	42	18	11	70m6	62.5	140	20	42
PLSES 315 LG/MGU	22	14	80m6	71	170	20	42	22	14	80m6	71	170	20	42
PLSES 315 VLG/VLGU	22	14	80m6	71	170	20	42	22	14	80m6	71	170	20	42
PLSES 355 LA	28	16	110m6	100	210	24	50	22	14	80m6	71	170	20	42
PLSES 355 LB	28	16	110m6	100	210	24	50	22	14	80m6	71	170	20	42
PLSES 355 LC	-	-	-	-	-	-	-	22	14	80m6	71	170	20	42
PLSES 400 LA	32	18	120m6	109	210	24	50	-	-	-	-	-	-	-
PLSES 400 LB	32	18	120m6	109	210	24	50	-	-	-	-	-	-	-
PLSES 400 LD	32	18	120m6	109	210	24	50	-	-	-	-	-	-	-
PLSES 450 LA	-	-	-	-	-	-	-	22	14	85m6	76	170	20	42
PLSES 450 LB	-	-	-	-	-	-	-	22	14	85m6	76	170	20	42

IP23 DRIP-PROOF MOTORS

IMfinity® 3-phase induction motors - IE2 - IE3 - IE4 - Non IE Efficiency

IP23 Aluminium or Steel frame

Dimensions

Foot mounted IM 1001 (IM B3)

Dimensions in millimetres

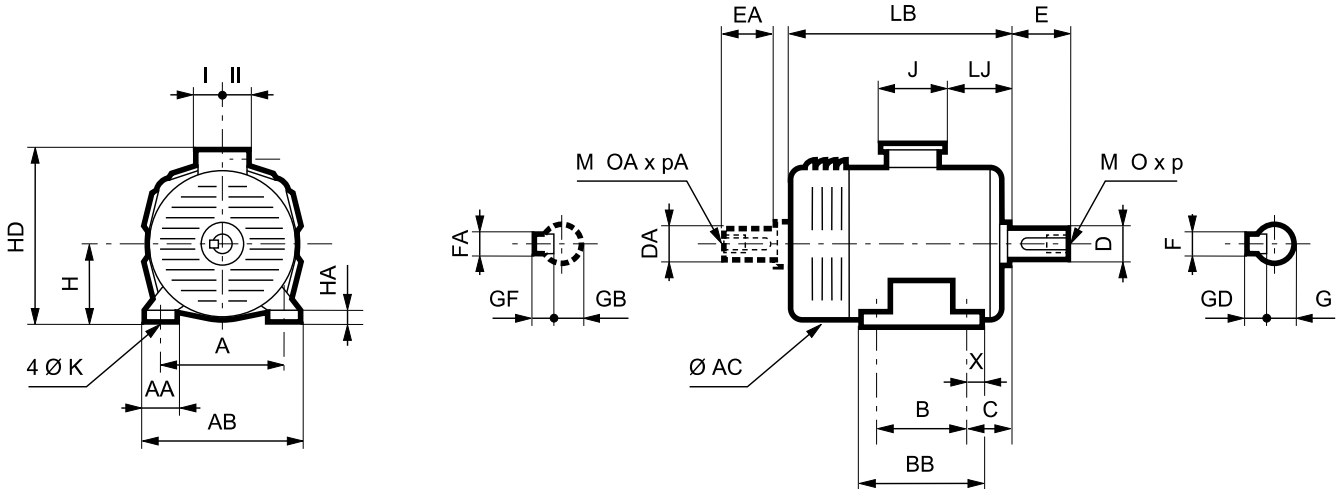

Type	Main dimensions																
	A	AB	B	BB	C	X	AA	K	HA	H	AC*	HD	LB	LJ	J	I	II
PLSES 225 MG	356	416	311	351	149	20	60	19	26	225	443	629	824	175.5	292	151	181
PLSES 250 MF	406	466	349	397	168	24	60	24	26	250	443	654	904	209	292	151	181
PLSES 250 MP	406	470	349	400	168	26	94	24	40	250	490	643	779	157.5	292	151	181
PLSES 250 SP	406	470	311	400	168	26	94	24	40	250	490	643	779	157.5	292	151	181
PLSES 280 MD	457	517	419	467	190	24	60	24	26	280	443	684	904	209	292	151	181
PLSES 280 SGJ	457	537	368	499	190	40	80	24	27	280	548	830	939	241	420	180	235
PLSES 280 MG	457	537	419	499	190	40	80	24	27	280	548	830	939	241	420	180	235
PLSES 280 SGU	457	537	368	499	190	40	80	24	27	280	600	830	1024	241	420	180	235
PLSES 280 MGU	457	537	419	499	190	40	80	24	27	280	600	830	1024	241	420	180	235
PLSES 280 SD	457	517	419	467	190	24	60	24	26	280	443	684	904	209	292	151	181
PLSES 315 L	508	608	508	588	216	40	100	28	26	315	548	860	1026	242	420	180	236
PLSES 315 LD	508	608	508	588	216	40	100	28	26	315	548	860	1086	242	420	180	236
PLSES 315 LG/MGU	508	608	508	588	216	40	100	28	26	315	624	876	1261	248	428	206	202
PLSES 315 SU	508	608	406	486	216	40	100	28	26	315	600	865	940	241	420	180	235
PLSES 315 MU	508	608	457	537	216	40	100	28	26	315	600	865	940	241	420	180	235
PLSES 315 LU	508	608	508	588	216	40	100	28	26	315	600	865	1104	241	420	180	235
PLSES 315 LUS	508	608	508	588	216	40	100	28	26	315	600	865	1104	241	420	180	235
PLSES 315 M	508	608	457	537	216	40	100	28	26	315	600	860	940	242	420	180	236
PLSES 315 MUR	508	608	457	537	216	40	100	28	26	315	600	860	1106	242	420	180	236
PLSES 315 S	508	608	406	486	216	40	100	28	26	315	600	860	881	242	420	180	236
PLSES 315 SUR	508	608	406	486	216	40	100	28	26	315	600	860	1026	242	418	180	236
PLSES 315 VLG	508	608	560	640	216	40	100	28	26	315	624	876	1321	248	428	206	202
PLSES 315 VLGU	508	608	560	640	216	40	100	28	26	315	624	876	1391	248	428	206	202
PLSES 355 LA	610	710	630	710	254	40	100	28	26	355	705	1078	1470	130	700	224	396
PLSES 355 LB	610	710	630	710	254	40	100	28	26	355	705	1078	1470	130	700	224	396
PLSES 355 LC	610	710	630	710	254	40	100	28	26	355	705	1078	1470	130	700	224	396
PLSES 400 LA	686	806	710	800	280	45	120	35	26	400	795	1173	1755	177	700	224	396
PLSES 400 LB	686	806	710	800	280	45	120	35	26	400	795	1173	1755	177	700	224	396
PLSES 400 LD	686	806	710	800	280	45	120	35	26	400	795	1173	1755	177	700	224	396
PLSES 450 LA	750	845	1000	1245	200	65	120	42	40	450	820	1223	1688	915	700	224	396
PLSES 450 LB	750	845	1000	1245	200	65	120	42	40	450	820	1223	1688	915	700	224	396

* AC: housing diameter without lifting rings

IMfinity® 3-phase induction motors - IE2 - IE3 - IE4 - Non IE Efficiency IP23 Aluminium or Steel frame

Dimensions

Foot and flange mounted IM 2001 (IM B35)

Dimensions in millimetres

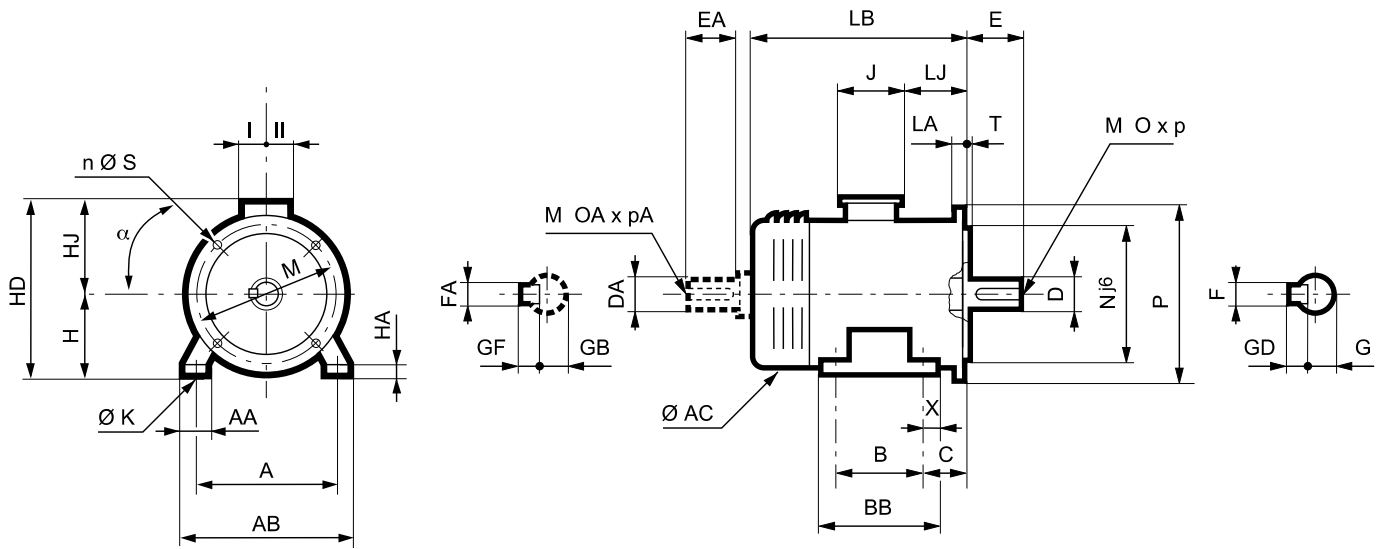

Type	Main dimensions																		
	A	AB	B	BB	C	X	AA	K	HA	H	AC*	HD	HJ	LB	LJ	J	I	II	Symbol
PLSES 225 MG	356	416	311	351	149	20	60	19	26	225	443	629	404	824	175.5	292	151	181	FF 500
PLSES 250 MF ¹	406	466	349	397	168	24	60	24	26	250	443	654	404	904	209	292	151	181	FF 600
PLSES 250 MP ¹											490		393	779	157.5	292	151	181	FF 600
PLSES 250 SF ¹	406	470	311	400	168	26	94	24	40	250	443	654	404	904	209	292	151	181	FF 600
PLSES 250 SP ¹											490		393	779	157.5	292	151	181	FF 600
PLSES 280 MD ¹	457	517	419	467	190	24	60	24	26	280	443	684	404	904	209	292	151	181	FF 600
PLSES 280 SGJ ¹											548		550	939	241	420	180	235	FF 600
PLSES 280 MG ¹											548		550	939	241	420	180	235	FF 600
PLSES 280 SGU ¹	457	537	368	499	190	40	80	24	27	280	600	830	550	1024	241	420	180	235	FF 600
PLSES 280 MGU ¹	457	537	419	499	190	40	80	24	27	280	600	830	550	1024	241	420	180	235	FF 600
PLSES 280 SD ¹											443		404	904	209	292	151	181	FF 600
PLSES 315 L ¹	508	608	508	588	216	40	100	28	26	315	548	860	545	1026	242	420	180	236	FF 740
PLSES 315 LD ¹	508	608	508	588	216	40	100	28	26	315	548	860	545	1086	242	420	180	236	FF 740
PLSES 315 LG ¹	508	608	508	588	216	40	100	28	26	315	624	876	561	1261	248	428	206	202	FF 740
PLSES 315 SU ¹	508	608	406	486	216	40	100	28	26	315	600	865	550	939	241	420	180	235	FF 740
PLSES 315 MU ¹	508	608	457	588	216	40	100	27	26	315	600	865	550	939	241	420	180	235	FF 740
PLSES 315 LU ¹											600		550	1104	241	420	180	235	FF 740
PLSES 315 LUS ¹	508	608	508	588	216	40	100	28	26	315	600	865	550	1104	241	420	180	235	FF 740
PLSES 315 M ¹	508	608	457	537	216	40	100	28	26	315	600	860	545	940	242	420	180	236	FF 740
PLSES 315 MUR ¹	508	608	457	537	216	40	100	28	26	315	600	860	545	1106	242	420	180	236	FF 740
PLSES 315 MGU ¹	508	608	457	588	216	40	100	28	26	315	624	876	561	1261	248	428	206	202	FF 740
PLSES 315 S ¹	508	608	406	486	216	40	100	28	26	315	600	860	545	1106	242	420	180	236	FF 740
PLSES 315 SUR ¹	508	608	406	486	216	40	100	28	26	315	600	860	545	1038	242	420	180	236	FF 740
PLSES 315 VLG ¹	508	608	560	640	216	40	100	28	26	315	624	876	561	1321	248	428	206	202	FF 740
PLSES 315 VLGU	508	608	560	640	216	40	100	28	26	315	624	876	561	1391	248	428	206	202	FF 740
PLSES 355 LA	610	710	630	710	254	40	100	28	26	355	705	1078	723	1470	130	700	224	396	FF 940
PLSES 355 LB	610	710	630	710	254	40	100	28	26	355	705	1078	723	1470	130	700	224	396	FF 940
PLSES 355 LC	610	710	630	710	254	40	100	28	26	355	705	1078	723	1470	130	700	224	396	FF 940
PLSES 400 LA	686	806	710	800	280	45	120	35	26	400	795	1173	773	1755	177	700	224	396	FF 940
PLSES 400 LB	686	806	710	800	280	45	120	35	26	400	795	1173	773	1755	177	700	224	396	FF 940
PLSES 400 LD	686	806	710	800	280	45	120	35	26	400	795	1173	773	1755	177	700	224	396	FF 940
PLSES 450 LA	750	845	1000	1245	200	65	120	42	40	400	820	1223	773	1688	915	700	224	396	FF 1080
PLSES 450 LB	750	845	1000	1245	200	65	120	42	40	450	820	1223	773	1688	915	700	224	396	FF 1080

1. For frame size ≥ 250 mm used as IM B5 (IM 3001), please consult Leroy-Somer.

* AC: housing diameter without lifting rings

IEC symbol	Flange dimensions							
	M	N	P	T	n	α°	s	LA
FF 400	400	350	450	5	8	22.5	18.5	16
FF 500	500	450	550	5	8	22.5	18.5	18
FF 600	600	550	660	6	8	22.5	22	25
FF 740	740	680	800	6	8	22.5	22	25
FF 940	940	880	1000	6	8	22.5	28	28
FF 1080	1080	1000	1150	6	8	22.5	28	30

IP23 DRIP-PROOF MOTORS

IMfinity® 3-phase induction motors - IE2 - IE3 - IE4 - Non IE Efficiency IP23 Aluminium or Steel frame

Dimensions

Flange mounted IM 3001 (IM B5) IM 3011 (IM V1)

Dimensions in millimetres

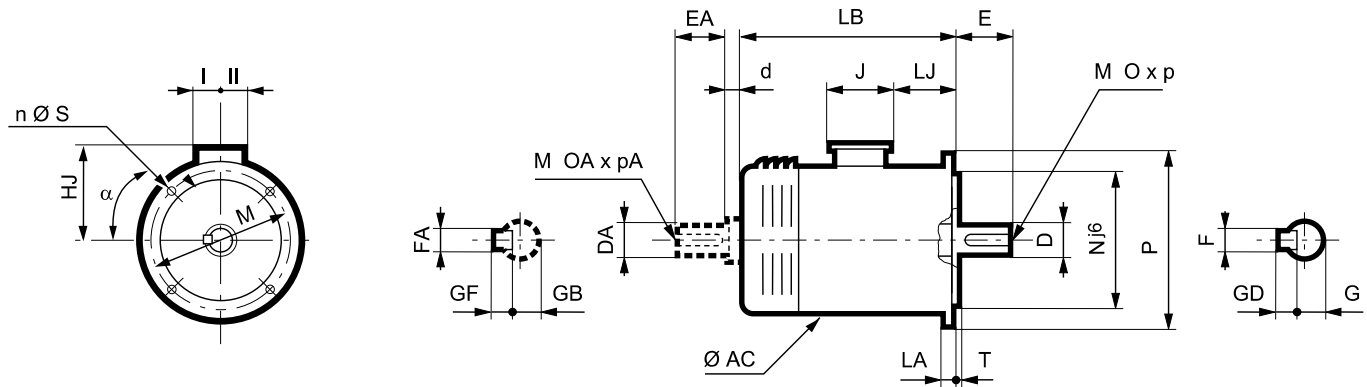

Type	Main dimensions								Symbol
	AC	HJ	LB	LJ	J	I	II		
PLSES 225 MG	443	404	824	175.5	292	151	181	FF 500	
PLSES 250 MF*	443	404	904	209	292	151	181	FF 600	
PLSES 250 SF*	443	404	904	209	292	151	181	FF 600	
PLSES 280 MD*	443	404	904	209	292	151	181	FF 600	
PLSES 280 MGU*	548	545	1038	242	418	180	236	FF 600	
PLSES 280 SGU*	548	545	1038	242	418	180	236	FF 600	
PLSES 315 L*	548	545	1026	242	418	180	236	FF 740	
PLSES 315 LD*	548	545	1086	242	418	180	236	FF 740	
PLSES 315 LG*	629	561	1261	248	428	206	202	FF 740	
PLSES 315 LUS*	548	545	1106	242	418	180	236	FF 740	
PLSES 315 M*	600	545	940	242	418	180	236	FF 740	
PLSES 315 MGU*	629	561	1261	248	428	206	202	FF 740	
PLSES 315 MUR*	600	545	1118	242	418	180	236	FF 740	
PLSES 315 MU*	600	547	1025	242	418	180	235	FF 740	
PLSES 315 S*	600	545	881	242	418	180	236	FF 740	
PLSES 315 SU*	600	547	940	242	418	180	235	FF 740	
PLSES 315 SUR*	600	545	1038	242	418	180	236	FF 740	
PLSES 315 VLG*	629	561	1321	248	428	206	202	FF 740	
PLSES 315 VLGU	629	561	1391	248	428	206	202	FF 740	
PLSES 355 LA	705	723	1470	130	700	224	396	FF 940	
PLSES 355 LB	705	723	1470	130	700	224	396	FF 940	
PLSES 355 LC	705	723	1470	130	700	224	396	FF 940	
PLSES 400 LA	795	773	1755	177	700	224	396	FF 940	
PLSES 400 LB	795	773	1755	177	700	224	396	FF 940	
PLSES 400 LD	795	773	1755	177	700	224	396	FF 940	
PLSES 450 LA	820	773	1856	915	700	224	396	FF 1080	
PLSES 450 LB	820	773	1856	915	700	224	396	FF 1080	

* For frame size ≥ 250 mm used as IM B5 (IM 3001), please consult Leroy-Somer.

IEC Symbol	Flange dimensions							
	M	N	P	T	n	α°	s	LA
FF 400	400	350	450	5	8	22.5	18.5	16
FF 500	500	450	550	5	8	22.5	18.5	18
FF 600	600	550	660	6	8	22.5	22	25
FF 740	740	680	800	6	8	22.5	22	25
FF 940	940	880	1000	6	8	22.5	28	28
FF 940	940	880	1000	6	8	22.5	28	28
FF 940	940	880	1000	6	8	22.5	28	28
FF 940	940	880	1000	6	8	22.5	28	28
FF 940	940	880	1000	6	8	22.5	28	28
FF 940	940	880	1000	6	8	22.5	28	28
FF 1080	1080	1000	1150	6	8	22.5	28	30
FF 1080	1080	1000	1150	6	8	22.5	28	30

IMfinity® 3-phase induction motors - IE2 - IE3 - IE4 - Non IE Efficiency

IP23 Aluminium or Steel frame

Construction

Bearings and lubrication

BEARING WITH GREASE NIPPLES

The chart opposite shows the greasing intervals, depending on the type of motor, for standard bearing assemblies of frame size ≥ 250 mm fitted with grease nipples, operating at an ambient temperature of 25°C, 40°C and 55°C on a horizontal shaft machine.

The chart below is valid for PLSES motors lubricated with Polyrex EM103 grease, which is used as standard.

SPECIAL CONSTRUCTION AND ENVIRONMENT

For vertical shaft machines, the greasing intervals will be approximately 80% of the values stated in the table below.

Note: The quality and quantity of grease and the greasing interval are shown on the machine nameplate.

For special assemblies (motors fitted with DE roller bearings or other types), machines of frame size ≥ 160 mm have bearings with grease nipples.

Instructions for bearing maintenance are given on the nameplates on these machines.

Series	Type	No. of poles	Type of bearing for bearings with grease nipples*		Quantity of grease g	Greasing intervals in hours									
			N.D.E.	D.E.		3000 min ⁻¹			1500 min ⁻¹			1000 min ⁻¹			
						25°C	40°C	55°C	25°C	40°C	55°C	25°C	40°C	55°C	
PLSES	225 MG	2; 4	6314 C3	6317 C3	40	8000	4000	2000	19600	9800	4900	-	-	-	
	250 SF	2; 4			40										
	250 MF	2; 4			40										
	280 MD	2	6316 C3	6320 C3	40	-	-	-	15800	7900	3950	-	-	-	
	280 SGJ	4			50										
	280 MG	4			50										
	280 SGU	4			50										
	280 MGU	4			50										
	315 SUR	4			50										
	315 MUR	4			50										
	315 LUS	4			50										
	315 SU	2			50										
	315 MU	2			50										
	315 L	2	35	6316 C3	6317 C3	9000	4500	2250	-	-	-	-	-	-	
	315 LU	4	6224 C3												45
	315 LD	2	6219 C3	35	8000	4000	2000	-	-	-	-	-	-	-	-
	315 LG/MGU	2	6317 C3	6317 C3	35	6500	6500	4095	-	-	-	-	-	-	-
		4	6317 C3	6322 C3	55	-	-	-	13200	13200	8316	-	-	-	-
	315 VLG/VLGU	2	6317 C3	6317 C3	35	6500	6500	4095	-	-	-	-	-	-	-
		4	6317 C3	6322 C3	55	-	-	-	13200	13200	8316	-	-	-	-
	355 L	2	6317 C3	6317 C3	35	6500	6500	4095	-	-	-	-	-	-	-
		4	6324 C3	6324 C3	72	-	-	-	7500	3700	2800	-	-	-	-
	355 LA	2	6317 C4	6317 C4	35	6500	6500	4095	-	-	-	-	-	-	-
	355 LA	6	6324 C3	6324 C3	72	-	-	-	-	-	-	20000	20000	20000	-
	355 LB	2	6317 C4	6317 C4	35	6500	6500	4095	-	-	-	-	-	-	-
	355 LB	4	6324 C3	6324 C3	72	-	-	-	7500	3700	2800	-	-	-	-
	355 LB	6	6324 C3	6324 C3	72	-	-	-	-	-	-	20000	20000	20000	-
	355 LC	2	6317 C4	6317 C4	35	6500	6500	4095	-	-	-	-	-	-	-
	400 L	4	6328 C3	6328 C3	93	-	-	-	4600	2300	1100	-	-	-	-
	400 LA	6			93	-	-	-	-	-	-	-	18200	18200	18500
400 LB	4	93			-	-	-	4600	2300	1100	-	-	-	-	
400 LB	6	93			-	-	-	-	-	-	-	18200	18200	18500	
400 LD	6	93			-	-	-	-	-	-	-	18200	18200	18500	
450 LA	2	6317 C4			6317 C4	35	6500	6500	4095	-	-	-	-	-	-
450 LB	2		35	6500		6500	4095	-	-	-	-	-	-		

* bearing with grease nipples on request

STANDARD BEARING FITTING ARRANGEMENTS

PLSES series		Horizontal shaft	Vertical shaft	
			Shaft facing down	Shaft facing up
Foot mounted motors	Mounting arrangement	B3	V5	V6
	standard mounting	The DE bearing is: - located at DE for frame 180 - locked for frame ≥ 200	The DE bearing is: - located at DE for frame 180 - locked for frame ≥ 200	The DE bearing is locked
	on request	DE bearing locked for frame 180	The DE bearing is locked for frame 180	
Flange mounted motors (or foot and flange)	Mounting arrangement	B5 / B35	V1 / V15	V3 / V36
	standard mounting	The DE bearing is locked	The DE bearing is locked	The DE bearing is locked

IMfinity® 3-phase induction motors - IE2 - IE3 - IE4 - Non IE Efficiency

IP23 Aluminium or Steel frame

Construction

Axial loads

HORIZONTAL MOTOR

For a bearing life L_{10h}
of 25,000 hours
and 40,000 hours

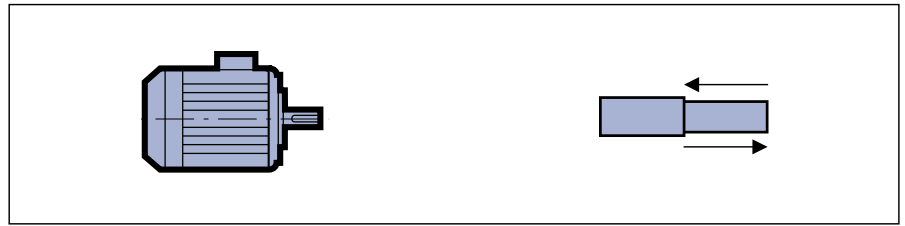

Series	Type	No. of poles	Permissible axial load (in daN) on main shaft extension for standard bearing assembly													
			3000 min ⁻¹						1500 min ⁻¹				1000 min ⁻¹			
			→		←		→		←		→		←			
			25,000 hours	40,000 hours	25,000 hours	40,000 hours	25,000 hours	40,000 hours	25,000 hours	40,000 hours	25,000 hours	40,000 hours	25,000 hours	40,000 hours		
PLSES	225 MG	2; 4	474	390	394	310	607	494	527	414	-	-	-	-		
	250 SF	2; 4	469	385	389	305	581	470	501	390	-	-	-	-		
	250 MF	2; 4	460	377	380	297	554	445	474	365	-	-	-	-		
	280 MD	2	375	292	455	372	-	-	-	-	-	-	-	-		
	280 SGJ	4	-	-	-	-	812	670	632	490	-	-	-	-		
	280 MG	4	-	-	-	-	809	666	629	486	-	-	-	-		
	280 SGU	4	-	-	-	-	798	656	618	476	-	-	-	-		
	280 MGU	4	-	-	-	-	794	652	614	472	-	-	-	-		
	315 L	2	457	380	277	200	-	-	-	-	-	-	-	-		
	315 LD	2	375	310	195	130	-	-	-	-	-	-	-	-		
	315 SU	2	472	395	292	215	-	-	-	-	-	-	-	-		
	315 MU	2; 4	460	383	280	203	783	642	603	462	-	-	-	-		
	315 M	2	469	391	289	211	-	-	-	-	-	-	-	-		
	315 SUR	4	-	-	-	-	787	645	607	465	-	-	-	-		
	315 MUR	4	-	-	-	-	763	623	583	443	-	-	-	-		
	315 LG/MGU	2; 4	504	417	364	277	860	703	720	563	-	-	-	-		
	315 LU	4	-	-	-	-	630	513	450	333	-	-	-	-		
	315 LUS	2; 4	758	618	578	438	755	615	575	435	-	-	-	-		
	315 VLG	2; 4	508	-	208	-	880	-	580	-	-	-	-	-		
	315 VLGU	2; 4	530	-	250	-	846	-	546	-	-	-	-	-		
	355 L	2; 4	135	-	415	-	414	-	694	-	-	-	-	-		
	355 LA/LB/LC	2	135	-	415	-	-	-	-	-	-	-	-	-		
	355 LB	4	-	-	-	-	414	-	694	-	-	-	-	-		
355 LA/LB	6	-	-	-	-	-	-	-	-	600	-	907	-			
400 L/LA/LB	4	-	-	-	-	552	-	906	-	-	-	-	-			
400 LB	4	-	-	-	-	552	-	906	-	-	-	-	-			
400 LA/LB/LD	6	-	-	-	-	-	-	-	-	650	-	1020	-			
450 LA/LB	2	189	-	358	-	-	-	-	-	-	-	-	-			

IMfinity® 3-phase induction motors - IE2 - IE3 - IE4 - Non IE Efficiency

IP23 Aluminium or Steel frame

Construction

Axial loads

VERTICAL MOTOR SHAFT FACING DOWN

For a bearing life L_{10h}
of 25,000 hours
and 40,000 hours

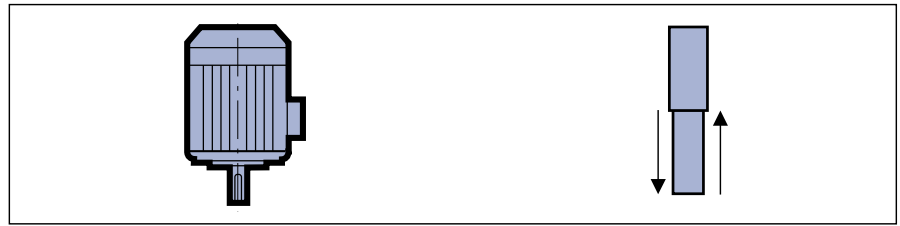

Series	Type	No. of poles	Permissible axial load (in daN) on main shaft extension for standard bearing assembly													
			3000 min ⁻¹						1500 min ⁻¹				1000 min ⁻¹			
			25,000 hours	40,000 hours	25,000 hours	40,000 hours	25,000 hours	40,000 hours	25,000 hours	40,000 hours	25,000 hours	40,000 hours	25,000 hours	40,000 hours		
PLSES	225 MG	2; 4	400	315	506	421	506	392	684	570	-	-	-	-		
	250 SF	2; 4	383	298	518	433	464	351	694	581	-	-	-	-		
	250 MF	2; 4	365	280	529	444	432	320	691	579	-	-	-	-		
	280 MD	2	282	198	605	520	-	-	-	-	-	-	-	-		
	280 SGJ	4	-	-	-	-	640	495	901	756	-	-	-	-		
	280 MG	4	-	-	-	-	624	479	913	768	-	-	-	-		
	280 SGU	4	-	-	-	-	605	460	929	784	-	-	-	-		
	280 MGU	4	-	-	-	-	579	434	951	806	-	-	-	-		
	315 L	2	302	222	518	439	-	-	-	-	-	-	-	-		
	315 LD	2	196	129	482	415	-	-	-	-	-	-	-	-		
	315 LG/MGU	2; 4	390	300	550	457	610	445	1124	957	-	-	-	-		
	315 SU	2	341	261	493	413	-	-	-	-	-	-	-	-		
	315 MU	2; 4	316	236	507	428	568	424	944	800	-	-	-	-		
	315 M	2	337	258	489	410	-	-	-	-	-	-	-	-		
	315 SUR	4	-	-	-	-	575	427	947	803	-	-	-	-		
	315 MUR	4	-	-	-	-	522	378	978	834	-	-	-	-		
	315 LU	4	-	-	-	-	374	254	862	742	-	-	-	-		
	315 VLG	2; 4	270	-	580	-	557	-	1085	-	-	-	-	-		
	315 VLGU	2; 4	250	-	630	-	483	-	1125	-	-	-	-	-		
	315 LUS	2; 4	503	359	991	847	514	370	973	829	-	-	-	-		
	355 LA/LB/LC	2	402	-	396	-	-	-	-	-	-	-	-	-		
	355 LB	4	-	-	-	-	573	-	893	-	-	-	-	-		
355 LA/LB	6	-	-	-	-	-	-	-	-	600	-	907	-			
400 L/LA/LB	4	-	-	-	-	568	-	1309	-	-	-	-	-			
400 LA/LB/LD	6	-	-	-	-	-	-	-	-	650	-	1020	-			
450 LA/LB	2	440	-	785	-	-	-	-	-	-	-	-	-			

IP23 DRIP-PROOF MOTORS

IMfinity® 3-phase induction motors - IE2 - IE3 - IE4 - Non IE Efficiency

IP23 Aluminium or Steel frame

Construction

Axial loads

VERTICAL MOTOR SHAFT FACING UP

For a bearing life L_{10h}
of 25,000 hours
and 40,000 hours

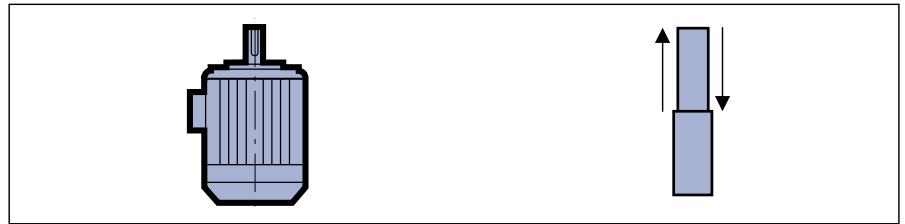

Series	Type	No. of poles	Permissible axial load (in daN) on main shaft extension for standard bearing assembly							
			3000 min ⁻¹				1500 min ⁻¹			
			25,000 hours	40,000 hours	25,000 hours	40,000 hours	25,000 hours	40,000 hours	25,000 hours	40,000 hours
			IM V6 IM V3 / V36							
PLSES	225 MG	2; 4	320	235	586	501	426	312	764	650
	250 SF	2; 4	303	218	598	513	384	661	774	271
	250 MF	4	285	200	609	524	352	240	771	659
	280 MD	2	362	278	525	440	-	-	-	-
	280 SGJ	4	-	-	-	-	460	315	1081	936
	280 MG	4	-	-	-	-	444	299	1093	948
	280 SGU	4	-	-	-	-	425	280	1109	964
	280 MGU	4	-	-	-	-	399	254	1131	986
	315 L	2	122	42	698	619	-	-	-	-
	315 LD	2	16	0	662	595	-	-	-	-
	315 SU	2	161	81	673	593	-	-	-	-
	315 MU	2; 4	136	56	687	608	388	244	1124	980
	315 M	2	157	78	669	590	-	-	-	-
	315 SUR	4	-	-	-	-	392	247	1127	983
	315 MUR	4	-	-	-	-	342	198	1158	1014
	315 LU	4	-	-	-	-	1042	922	194	74
	315 LUS	2; 4	323	179	1171	1027	1153	1009	334	190
	315 LG/MGU	2; 4	60	0	498	444	682	518	1011	848
	315 VLG	2; 4	30	-	878	-	257	-	1385	-
	315 VLGU	2; 4	260	-	630	-	183	-	1425	-
	355 L/LA/LB	2; 4	600	-	1396	-	427	-	1893	-
	400 L/LA/LB	4	-	-	-	-	632	-	2570	-
450	2	Please consult Leroy-Somer specifying the coupling method and the axial and radial loads if applicable								

IMfinity® 3-phase induction motors - IE2 - IE3 - IE4 - Non IE Efficiency

IP23 Aluminium or Steel frame

Construction

Radial loads

STANDARD FITTING ARRANGEMENT

Permissible radial load on main shaft extension with a bearing life L_{10h} of 25,000 hours.

FR : Radial Force

X: Distance with respect to the shaft shoulder

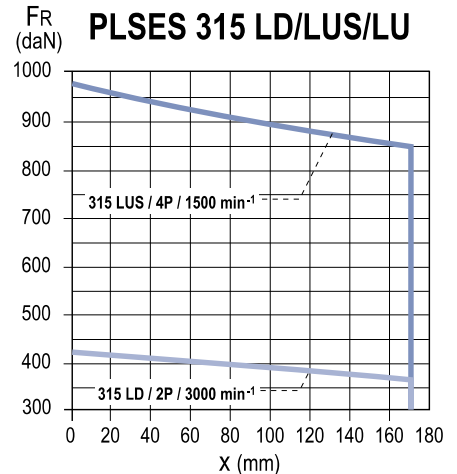
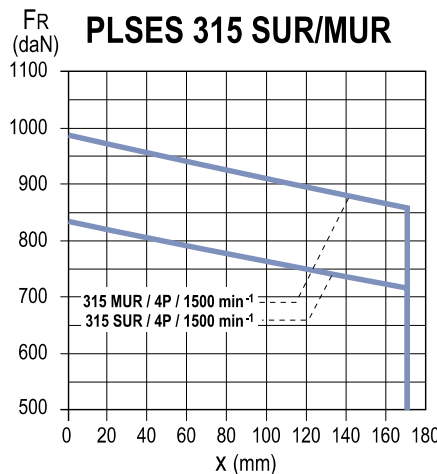
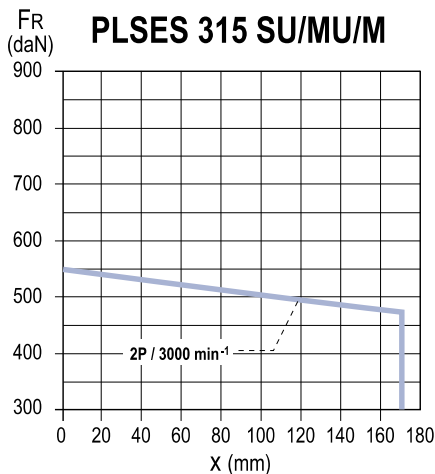
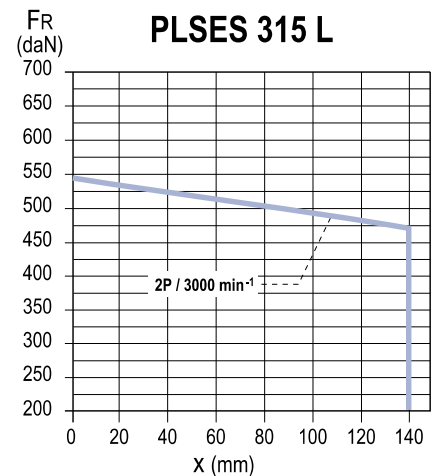
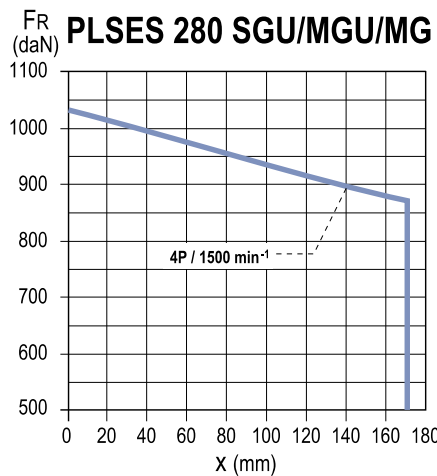
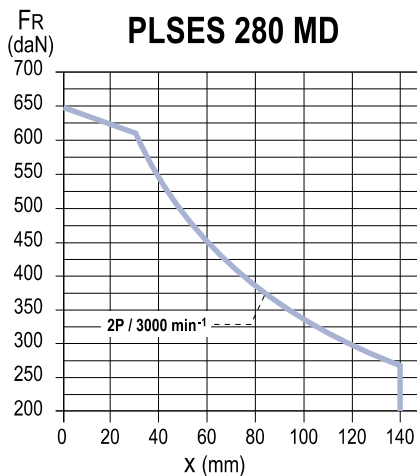
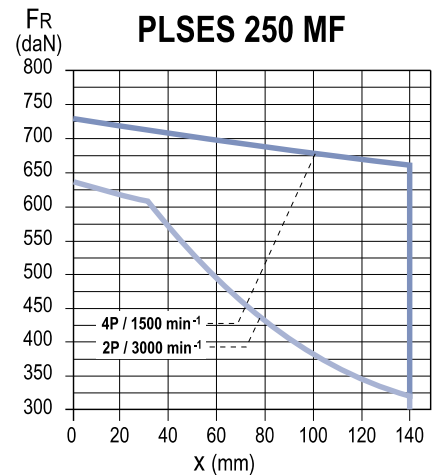
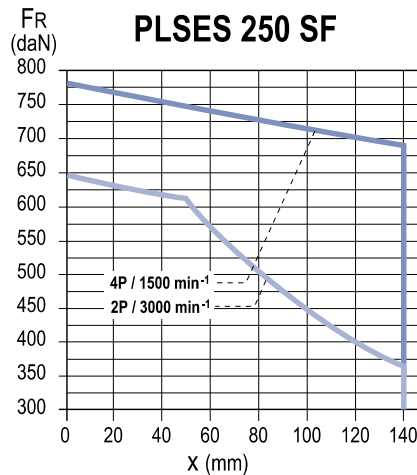
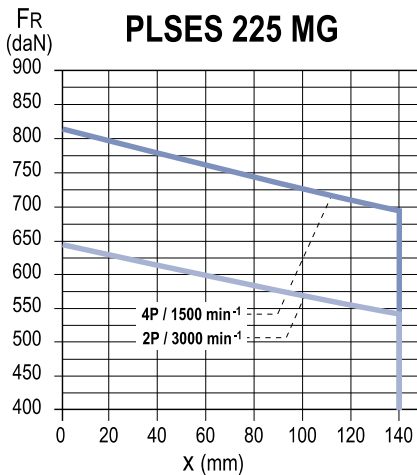

IP23 DRIP-PROOF MOTORS

IMfinity® 3-phase induction motors - IE2 - IE3 - IE4 - Non IE Efficiency

IP23 Aluminium or Steel frame

Construction

Radial loads

STANDARD FITTING ARRANGEMENT

Permissible radial load on main shaft extension with a bearing life L_{10h} of 25,000 hours.

FR: Radial Force

X: Distance with respect to the shaft shoulder

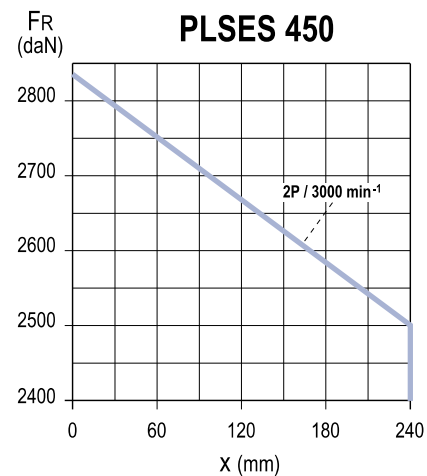
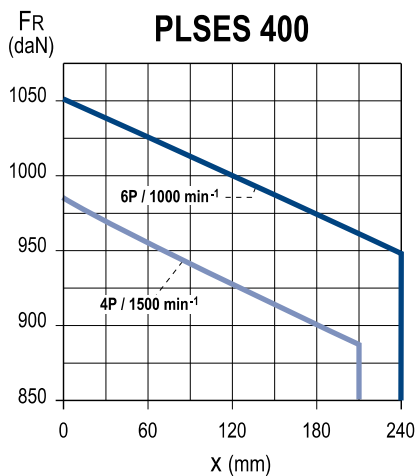
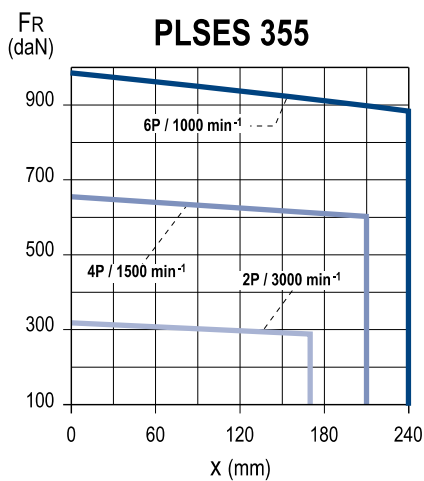
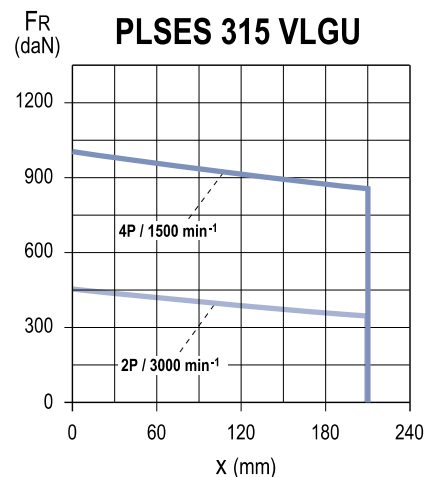
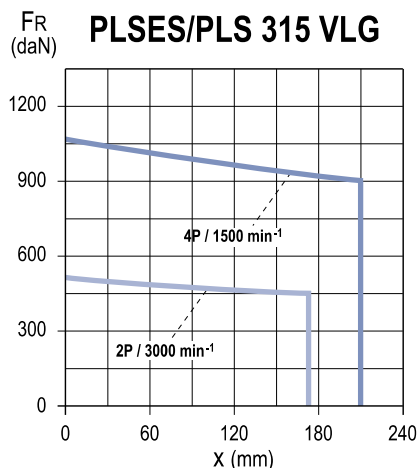
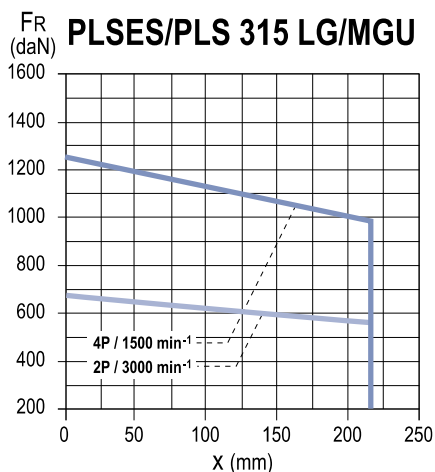

IMfinity® 3-phase induction motors - IE2 - IE3 - IE4 - Non IE Efficiency

IP23 Aluminium or Steel frame

Construction

Radial loads

SPECIAL FITTING ARRANGEMENT

Type of drive end roller bearings

Series	Type	No. of poles	Non drive end bearing (N.D.E.)	Drive end bearing (D.E.)
PLSES	225 MG	4	6314 C3	NU 317
	250 SF	4		
	250 MF	4		
	280 MD	4		
	280 SGU/SGJ	4		
	280 MGU	4	6316 C3	NU 320
	315 SUR/SU	4		
	315 MUR	4		
	315 LUS	4		
	315 L	4		
	315 LD	4		
	315 LG/MGU	4		
	315 VLG/VLGU	4	6317 C3	NU 322
	355 LA	2	6317 C4	-
	355 LA	4; 6	6324 C3	NU 324
	355 LB	2	6317 C4	
	355 LB	4; 6	6324 C3	
	355 LC	2	6317 C4	-
	400 LA	4; 6	6328 C3	NU 328
	400 LB	4		
400 LB/LD	6			
450 LA	2	6317 C4	-	
450 LB	2			

IMfinity® 3-phase induction motors - IE2 - IE3 - IE4 - Non IE Efficiency

IP23 Aluminium or Steel frame

Construction

Radial loads

SPECIAL FITTING ARRANGEMENT

Permissible radial load on main shaft extension with a bearing life L_{10h} of 25,000 hours.

FR: Radial Force

X: Distance with respect to the shaft shoulder

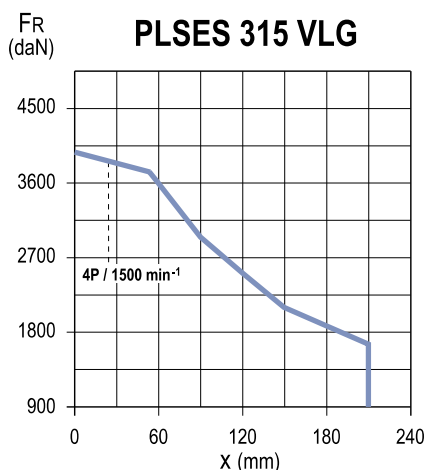
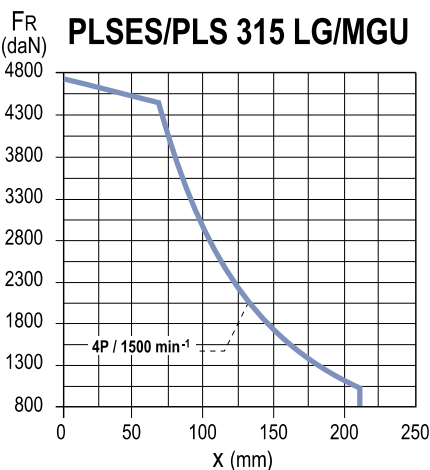
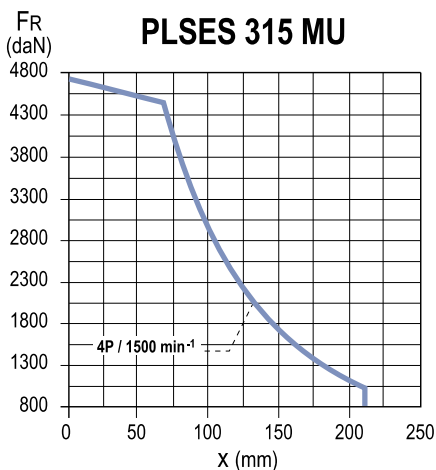
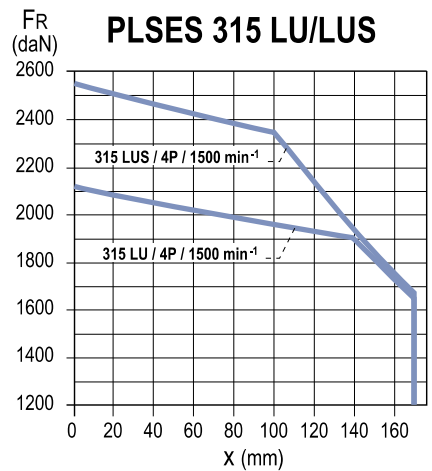
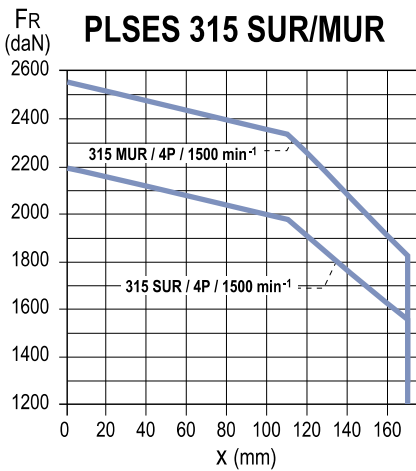
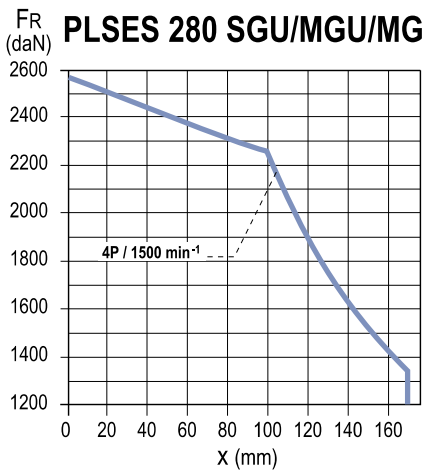
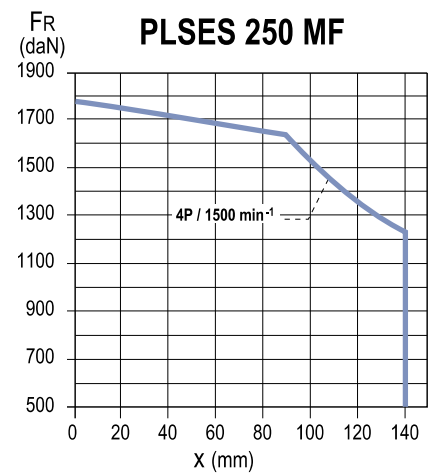
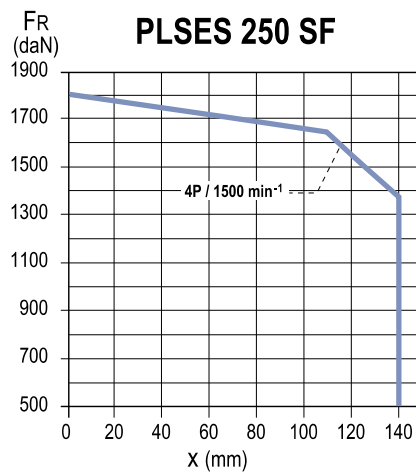
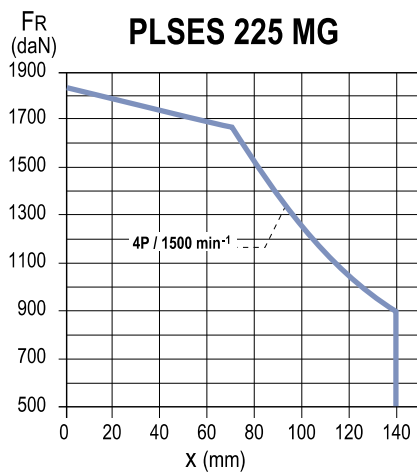

IP23 DRIP-PROOF MOTORS

IMfinity® 3-phase induction motors - IE2 - IE3 - IE4 - Non IE Efficiency

IP23 Aluminium or Steel frame

Construction

Radial loads

SPECIAL FITTING ARRANGEMENT

Permissible radial load on main shaft extension with a bearing life L_{10h} of 25,000 hours.

FR: Radial Force

X: Distance with respect to the shaft shoulder

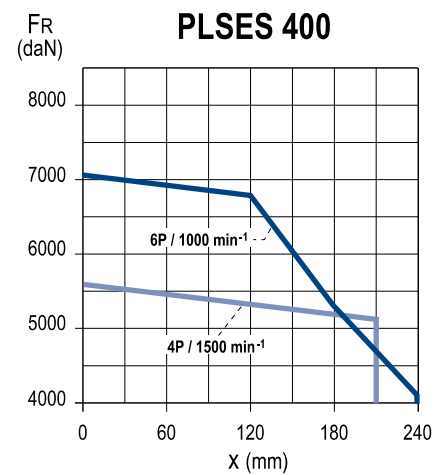
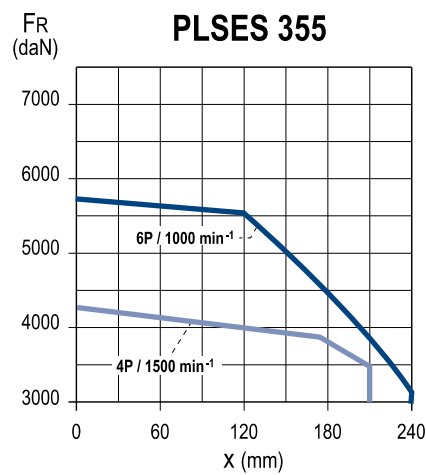
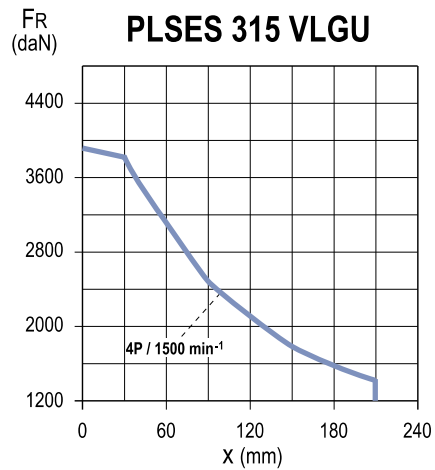

IMfinity® 3-phase induction motors - IE2 - IE3 - IE4 - Non IE Efficiency

IP23 Aluminium or Steel frame

Optional features

Mechanical options

MODIFIED FLANGES

Motor type \ Flange type	(FF) Flange mounted							
	FF 300	FF 350	FF 400	FF 500	FF 600	FF 740	FF 940	FF 1080
PLSES 225 MG			◆	●				
PLSES 250 SP/MP/MF				◆	●			
PLSES 280 MD/MG/SGJ				◆	●			
PLSES 315 S/SUR/L/LD/M/MUR/LUS/SU					◆	●		
PLSES 315					◆	●		
PLSES 355						◆	●	
PLSES 400							●	◆
PLSES 450								●

● Standard ◆ Adaptable without shaft modification

Mechanical and electrical options

MOTORS WITH FORCED VENTILATION

The integration of high-efficiency motors within a process often requires accessories to make operation easier:

- Forced ventilation for motors used at high or low speeds.

Notes:

- Without forced ventilation, there is a possibility of overspeed with optional class B balancing.
- The motor temperature is monitored by sensors built into the windings.

MOTORS WITH SPACE HEATERS

Type	Power (W)
PLSES 225 to 280	84
PLSES 315	100
PLSES 355 / 400 / 450	200

The space heaters use 200/240 V single phase, 50 or 60 Hz.

IMfinity® 3-phase induction motors - IE2 - IE3 - IE4 - Non IE Efficiency

IP23 Aluminium or Steel frame

Installation and maintenance

Position of the lifting rings

LIFTING THE MOTOR ONLY (not coupled to the machine)

The regulations stipulate that over 25 kg, suitable handling equipment must be used.

All our motors are fitted with grab handles, making them easier to handle without risk. A diagram of the sling hoisting method appears below with the required dimensions.

To prevent any damage to the motor during handling (for example: switching the motor from horizontal to vertical), it is essential to follow these instructions.

HORIZONTAL POSITION

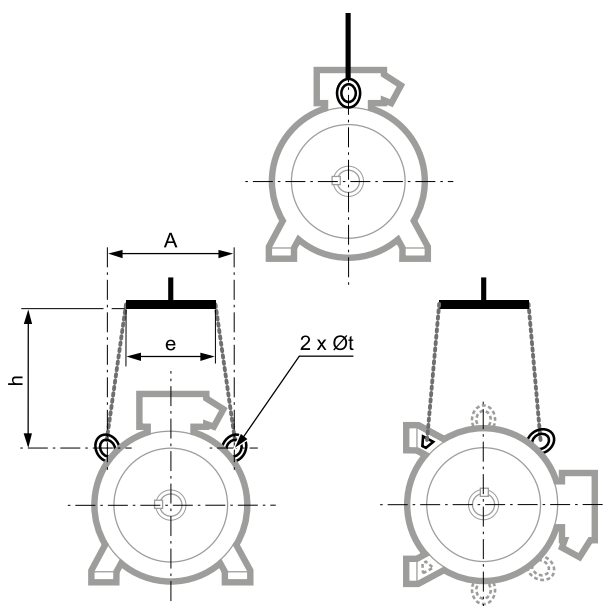

Type	Horizontal position			
	A	e min	h min	Øt
PLSES 225 MG	310	300	300	30
PLSES 250 MF/SF	310	300	300	30
PLSES 280 MD/MGU/SGU/SGJ	310	300	300	30
PLSES 315 SUR/MUR/L/LD/LUS/SU	385	380	500	30
PLSES 315 LG/MGU/VLG/VLGU	440	750	550	48
PLSES 355	504	850	630	67
PLSES 400	600	1010	750	67
PLSES 450	600	1010	750	67

VERTICAL POSITION

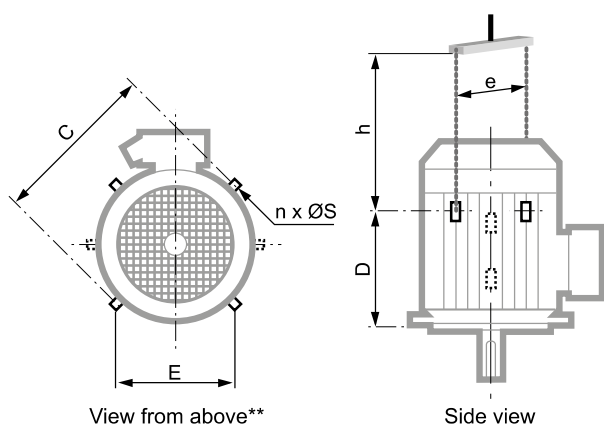

Type	Vertical position					
	C	E	n**	ØS	e mini*	h min
PLSES 225 MG	450	310	2	14	450	490
PLSES 250 MF/SF	450	310	4	30	450	490
PLSES 280 MD/MGU/SGU/SGJ	450	310	4	30	450	490
PLSES 315 SUR/MUR/L/LD/LUS/SU	500	385	4	30	500	500
PLSES 315 LG/MGU/VLG/VLGU	610	440	8	48	750	450
PLSES 355	710	504	8	48	800	530
PLSES 400	850	600	8	67	900	640
PLSES 450	900	600	8	67	930	610

* if the motor is fitted with a drip cover, allow an additional 50 to 100 mm to avoid damaging it when the load is swung.

** if n = 2, the lifting rings form an angle of 90° with respect to the axis of the terminal box.

If n = 4, this angle becomes 45°.

Notes

IMfinity® 3-phase induction motors - IE2 - IE3 - IE4 - Non IE Efficiency

Energy regulations worldwide

Regulations in the main countries

Several countries have already implemented energy regulations relating to electric motors. Others are in the process of drafting them.

Some regulations require products to be registered with the local authorities prior to release onto the market. In these cases, the market is monitored before starting to use the products, unlike the EU where the member states are allowed to organise monitoring on their own territory.









Most countries which impose product registration before release onto the market also usually require special product marking.

For Europe, there is no specific label. Only the CE mark indicates that the product conforms to all the relevant directives.

The table below summarises the main regulations existing worldwide.

These regulations are constantly changing and regular updates are necessary.

Leroy-Somer has registered some of its motor ranges in the majority of countries mentioned, depending on market requirements.

	Countries	Standard	Regulation	Label if requested	Mandatory registration	Power	Pole nbr	2015	2016	2017
	EUROPE	IEC60034-2-1 IEC60034-30-1	ErP 640/2009			0.75kW 375kW	2, 4, 6			
	SWISS	IEC60034-2-1 IEC60034-30-1	ordonnance 730.01			0.75kW 375kW	2, 4, 6	IE3	IE3	IE3
	TURKEY	IEC60034-2-1 IEC60034-30	SGM 2012/2			0.75kW 375kW	2, 4, 6			
	ISRAEL	IEC60034-2-1 IEC60034-30-1	SI 5289			0.75kW 185kW	2,4,6,8			
	USA	MG1 112-11 IEEE 112-B	EISA 10CFR431.31		X	1 HP- 200HP	2, 4, 6			
	CANADA	C747-09 C390-10	LC 1992 ch.36		X	1 HP- 200HP	2, 4, 6	IE3	IE3	IE3
	MEXICO	MG1 112-11 IEEE 112-B	CONUEE NOM-016-ENER		X	1 HP- 200HP	2, 4, 6			
	BRAZIL	NBR 17094-3 NBR 5383-1	INMETRO		X	0.75kW 185kW	2,4,6,8	IE2	IE3	IE3
	INDIA	IS 12615				0.75kW 375kW	2, 4, 6	IE3	IE3	IE3
	South KOREA	KSC IEC60034-2-1	KEMCO		X	0.75kW 200kW	2,4,6,8	IE3	IE3	IE3
	CHINA	GB18613-2012	CER		X	0.75kW 375kW	2, 4, 6	IE3	IE3	IE3
	AUSTRALIA	IEC60034-2-1 IEEE 112-B	E3		X	0.75kW 185kW	2,4,6,8	IE3	IE3	IE3
	NEW ZEALAND	IEC60034-2-1 IEEE 112-B	EECA		X	0.75kW 185kW	2,4,6,8	IE3	IE3	IE3
	JAPAN	JIS C4034-2-1 JIS C4034-30	TOP RUNNER			0.20kW 160kW	2, 4, 6	IE3	IE3	IE3
	TAIWAN	CNS 14400				0.75kW 200kW	2, 4, 6	IE3	IE3	IE3
	SAUDI ARABIA	SASO IEC60034-30-1	SEEP		X	0.75kW 375kW	2, 4, 6	IE2	IE2	IE3
	VIET NAM		VEESEL		X	≤ 20kW		IE	IE	IE

compulsory label

volontaire / voluntary
OBLIGATOIRE / COMPULSORY

IMfinity® 3-phase induction motors - IE2 - IE3 - IE4 - Non IE Efficiency Environment

Environments and special applications

Certain industries and processes are particularly harsh for electric motors.

To satisfy the demands of applications in harsh operating conditions, Leroy-Somer, thanks to its long experience in all types of application and feedback from users and service centres, has developed solutions suitable for the operational requirements.

CHEMICALS, PETROCHEMICALS, IRON & STEEL INDUSTRY, PAPER MILLS, SUGAR FACTORIES, CEMENT WORKS, ETC

Constraint: corrosive environment and harsh use.



Solution: motor with “Corrobloc” finish for cast iron motors.

- dielectric and anti-corrosion protection of the stator (coil end turns) and rotor
- stainless steel nameplate
- stainless steel screws
- cast iron terminal box body and cover
- terminal box cover with captive screws
- brass cable gland
- paint system IIIa (C4M corrosivity category in accordance with ISO 12944-2)



Ranges of proposed motors:

- frame size 90 to 450 mm
- power rating between 0.75 and 1250 kW



IMfinity® 3-phase induction motors - IE2 - IE3 - IE4 - Non IE Efficiency Environment

Environments and special applications

MERCHANT NAVY APPLICATIONS

ONBOARD INDUSTRIAL APPLICATIONS

- air compressors,
- refrigeration compressors,
- pumps,
- fans,
- conveyors.



Constraint: saline corrosion, harsh use, operational safety, conformance with classification body specifications according to type of use.

Solution: motors that allow any type of mechanical and electrical protection as required.



Motors for "Marine" application conform to the specifications of the IACS classification bodies (LR, RINA, BV, DNV, ABS, GL, etc): high ambient temperature, overload, increased tolerance with regard to rated voltage and frequency, overspeed, etc).

ELECTRICAL PROPULSION

- main propulsion
- auxiliary propulsion (bow thruster unit).



Constraint: reduced weight and dimensions, silent operation, high specific output power, low starting current, high efficiency, conformance with classification body specifications according to type of use.

Solution: IP23 air-cooled motors with air/water exchangers, water-cooled motors with double housing. Magnetic circuits able to cope with a high number of starts.



IMfinity® 3-phase induction motors - IE2 - IE3 - IE4 - Non IE Efficiency

Appendix

Cable gland support plates

Dimensions in millimetres

ZONES USED FOR DRILLING THE CABLE GLAND SUPPORT PLATES

IP55 aluminium motors		
Motor type	Diagram	Without extension feed (standard)
LSES 315	4	H = 170 L = 333



Diagram 1

IP55 cast iron motors		
Motor type	Diagram	Without extension feed (standard)
FLSES 160	3	H = 54 L = 131
FLSES 180		
FLSES 200		
FLSES 225 SR/MR	3	H = 80 L = 190
FLSES 225 S/M/SG		
FLSES 250	3	H = 80 L = 190
FLSES 280	3	H = 80 L = 190
FLSES 315	1	H = 115 L = 125
FLSES 355 L		
FLSES 355 LK	2	H = 170 L = 460
FLSES 400		
FLSES 450		

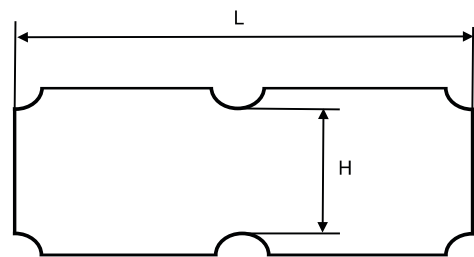

Diagram 2

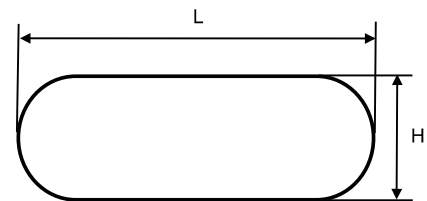
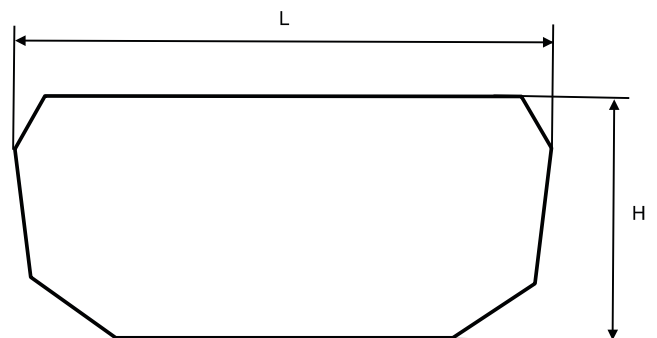

Diagram 3

IP23 drip-proof motors		
Motor type	Diagram	Without extension feed (standard)
PLSES 280 MGU/SGU	4	H = 170 L = 333
PLSES 315 L/LD/LUS/M/MUR		
PLSES 315 MU/S/SU/SUR		
PLSES 315 LG/MGU/VLG/VLGU	1	H = 115 L = 125
PLSES 355		
PLSES 400	2	H = 170 L = 460
PLSES 450		



Calculating the efficiency of an induction motor

MACHINE EFFICIENCY

Efficiency is the ratio between the output power (needed to drive a machine) and the power absorbed (power consumed). This value is therefore necessarily less than 1. The difference between the output power and the power absorbed consists of the electrical machine losses. 85% efficiency therefore means there are 15% losses.

Direct measurement method

With the direct method, efficiency is calculated using mechanical (torque C and speed Ω) and electrical (power absorbed P_{abs}) measurements. If the measuring tools are specified (use of a torquemeter), this method has the advantage of being relatively easy. However, it does not provide any information about machine performance and the origins of the potential losses.

$$\eta = \frac{P_u}{P_{abs}} \text{ where } P_u = C \Omega$$

Indirect measurement methods

These methods determine efficiency by determining the machine losses. Conventionally, a distinction is made between three types of losses: joule losses (stator P_{js} and rotor P_{jr}), iron losses (P_f) and mechanical losses (P_m) which are relatively easy to measure. Miscellaneous losses which are more difficult to determine, called additional losses, are added to these losses.

In standard IEC 60034-2 dated 1972 and applicable until November 2010, the method for calculating additional losses uses a fixed percentage of 0.5% of the power absorbed.

$$\eta = \frac{P_{abs} - P_{js} - P_{jr} - P_f - P_m - P_{sup}}{P_{abs}} \text{ where } P_{sup} = 0.5\% P_{abs}$$

Additional losses come from a variety of sources: surface losses, busbar currents, high-frequency losses, losses linked to leakage flux, etc. They are specific to each machine and contribute to reducing efficiency but they are very complex to calculate from a quantitative point of view.

In the new standard IEC 60034-2-1 dated September 2007, these additional losses must be measured precisely. This is a similar approach to that taken by the North American (IEEE112-B) and Canadian (CSA390) standards, which deduct the additional losses from a thermally-stable on-load curve.

The residual losses are calculated at each load point: 25%, 50%, 75%, 100%, 115% and 125%:

$$P_{res} = P_{abs} - P_{js} - P_{jr} - P_f - P_m - P_u \text{ where } P_u = C \Omega$$

The straight line is drawn by approximating the curve points as closely as possible. The measure is acceptable if a correlation coefficient of 0.95 or higher can be ensured.

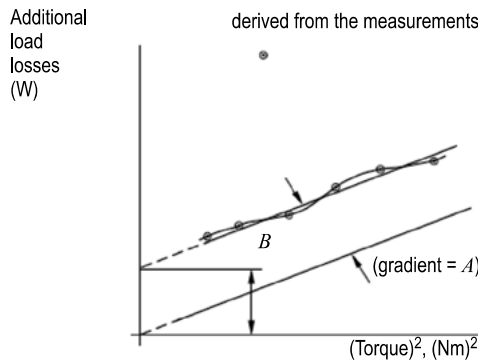

The line to 0 gives the additional losses at the nominal point, ie. at 100% load.

From then on, the usual equation gives the efficiency:

$$\eta = \frac{P_{abs} - P_{js} - P_{jr} - P_f - P_m - P_{sup}}{P_{abs}}$$

Note that with this method, the Joule losses must be corrected according to the temperature and the iron losses corrected according to the resistive voltage dip in the stator.

IMfinity® 3-phase induction motors - IE2 - IE3 - IE4 - Non IE Efficiency

Appendix

Units of measurement and standard formulae

ELECTRICITY AND ELECTROMAGNETISM

Parameters				Unit		Units and expressions not recommended
French name	English name	Symbol	Definition	SI	Non SI but accepted	Conversions
Fréquence Période	Frequency	f		Hz (hertz)		
Courant électrique (intensité de)	Electric current	I		A (ampere)		
Potentiel électrique Tension Force électromotrice	Electric potential Voltage Electromotive force	V U E		V (volt)		
Déphasage	Phase angle	φ		rad	° degree	
Facteur de puissance	Power factor	$\cos \varphi$				
Réactance Résistance Impédance	Reactance Resistance Impedance	X R Z		Ω (ohm)		j is defined as $j^2 = -1$ ω rotational frequency = $2\pi \cdot f$
Inductance propre (self)	Self inductance	L		H (henry)		
Capacité	Capacitance	C		F (farad)		
Charge électrique, Quantité d'électricité	Quantity of electricity	Q		C (coulomb)	A.h 1 A.h = 3 600 C	
Résistivité	Resistivity	ρ		$\Omega \cdot m$		Ω/m
Conductance	Conductance	G		S (siemens)		$1/\Omega = 1 S$
Nombre de tours, (spires) de l'enroulement Nombre de phases Nombre de paires de poles	N° of turns (coil) N° of phases N° of pairs of poles	N m p				
Champ magnétique	Magnetic field	H		A/m		
Différence de potentiel magnétique Force magnétomotrice Solénation, courant totalisé	Magnetic potential difference Magnetomotive force	Um F, Fm H		A		The unit AT (ampere-turns) is incorrect because it treats "turn" as a physical unit
Induction magnétique, Densité de flux magnétique	Magnetic induction Magnetic flux density	B		T (tesla) = Wb/m ²		(gauss) 1 G = 10 ⁻⁴ T
Flux magnétique, Flux d'induction magnétique	Magnetic flux	Φ		Wb (weber)		(maxwell) 1 max = 10 ⁻⁸ Wb
Potentiel vecteur magnétique	Magnetic vector potential	A		Wb/m		
Perméabilité d'un milieu Perméabilité du vide	Permeability Permeability of vacuum	$\mu = \mu_o \mu_r$ μ_o		H/m		
Permittivité	Permittivity	$\varepsilon = \varepsilon_o \varepsilon_r$		F/m		

IMfinity® 3-phase induction motors - IE2 - IE3 - IE4 - Non IE Efficiency

Appendix

Units of measurement and standard formulae

THERMODYNAMICS

Parameters				Unit		Units and expressions not recommended
French name	English name	Symbol	Definition	SI	Non SI but accepted	Conversions
Température Thermodynamique	Temperature Thermodynamic	T		K (kelvin)	temperature Celsius, t , °C $T = t + 273,15$	°C: Degree Celsius t_C : Temp. in °C t_F : Temp. in °F f temperature Fahrenheit °F
Écart de température	Temperature rise	ΔT		K	°C	1 °C = 1 K
Densité de flux thermique	Heat flux density	q, φ		W/m ²		
Conductivité thermique	Thermal conductivity	λ		W/m.K		
Coefficient de transmission thermique global	Total heat transmission coefficient	K		W/m ² .K		
Capacité thermique	Heat capacity	C		J/K		
Capacité thermique massique	Specific heat capacity	c		J/kg.K		
Energie interne	Internal energy	U		J		

NOISE AND VIBRATION

Parameters				Unit		Units and expressions not recommended
French name	English name	Symbol	Definition	SI	Non SI but accepted	Conversions
Niveau de puissance acoustique	Sound power level	L_w	$L_w = 10 \lg(P/P_o)$ ($P_o = 10^{-12} W$)	dB (decibel)		\lg logarithm to base 10 $\lg 10 = 1$
Niveau de pression acoustique	Sound pressure level	L_p	$L_p = 20 \lg(P/P_o)$ ($P_o = 2 \times 10^{-5} Pa$)	dB		

DIMENSIONS

Parameters				Unit		Units and expressions not recommended
French name	English name	Symbol	Definition	SI	Non SI but accepted	Conversions
Angle (angle plan)	Angle (plane angle)	$\alpha, \beta, T, \varphi$		rad	degree: ° minute: ' second: ''	180° = π rad = 3.14 rad
Longueur Largeur Hauteur Rayon Longueur curviligne	Length Breadth Height Radius	l b h r s		m (metre)	micrometre	cm, dm, dam, hm 1 inch = 1" = 25.4 mm 1 foot = 1" = 304.8 mm μ m micron μ angström: Å = 0.10 nm
Aire, superficie	Area	A, S		m ²		1 square inch = 6.45 10 ⁻³ m ²
Volume	Volume	V		m ³	litre: l liter: L	UK gallon = 4.546 10 ⁻³ m ³ US gallon = 3.785 10 ⁻³ m ³

IMfinity® 3-phase induction motors - IE2 - IE3 - IE4 - Non IE Efficiency

Appendix

Units of measurement and standard formulae

MECHANICS

Parameters				Unit		Units and expressions not recommended
English name	French name	Symbol	Definition	SI	Non SI but accepted	Conversions
Time	Temps	t				
Period (periodic time)	Intervalle de temps, durée Période (durée d'un cycle)	T		s (second)	minute: min hour: h day: d	Symbols ' and " are reserved for angles minute not written as mn
Angular velocity Circular frequency	Vitesse angulaire Pulsation	ω	$\omega = \frac{d\varphi}{dt}$	rad/s		
Angular acceleration	Accélération angulaire	α	$\alpha = \frac{d\omega}{dt}$	rad/s ²		
Speed	Vitesse	$u, v, w,$	$v = \frac{ds}{dt}$			
Velocity	Célérité	c		m/s	1 km/h = 0.277 778 m/s 1 m/min = 0.016 6 m/s	
Acceleration	Accélération	a	$a = \frac{dv}{dt}$	m/s ²		
Acceleration of free fall	Accélération de la pesanteur	$g =$	9.81 m/s^2 <i>in Paris</i>			
Revolution per minute	Vitesse de rotation	N		s ⁻¹	min ⁻¹	tr/mn, RPM, TM...
Mass	Masse	m		kg (kilogramme)	tonne: t 1 t = 1 000 kg	kilo, kgs, KG... 1 pound: 1 lb = 0.453 6 kg
Mass density	Masse volumique	ρ	$\frac{dm}{dV}$	kg/m ³		
Linear density	Masse linéique	ρ_e	$\frac{dm}{dL}$	kg/m		
Surface mass	Masse surfacique	ρ_A	$\frac{dm}{dS}$	kg/m ²		
Momentum	Quantité de mouvement	P	$p = m.v$	kg. m/s		
Moment of inertia	Moment d'inertie	J, I	$I = \sum m.r^2$	kg.m ²		$J = \frac{MD^2}{4}$ kg.m ² pound per square feet = 1 lb.ft ² = 42.1 x 10 ⁻³ kg.m ²
Force Weight	Force Poids	F G	$G = m.g$	N (newton)		kgf = kgp = 9.81 N pound force = lbF = 4.448 N
Moment of force, Torque	Moment d'une force	M T	$M = F.r$	N.m		mdaN, mkg, m.N 1 mkg = 9.81 N.m 1 ft.lbF = 1.356 N.m 1 in.lbF = 0.113 N.m
Pressure	Pression	p	$p = \frac{F}{S} = \frac{F}{A}$	Pa (pascal)	bar 1 bar = 10 ⁵ Pa	1 kgf/cm ² = 0.981 bar 1 psi = 6 894 N/m ² = 6 894 Pa 1 psi = 0.068 94 bar 1 atm = 1.013 x 10 ⁵ Pa
Normal stress Shear stress	Contrainte normale Contrainte tangentielle, Cission	σ τ		Pa we use MPa = 10 ⁶ Pa		kg/mm ² , 1 daN/mm ² = 10 MPa psi = pound per square inch 1 psi = 6 894 Pa
Friction coefficient	Facteur de frottement	μ				incorrectly = coefficient friction f
Work Energy Potential energy Kinetic energy Quantity of heat	Travail Énergie Énergie potentielle Énergie cinétique Quantité de chaleur	W E Ep Ek Q	$W = F.l$			
Power	Puissance	P	$P = \frac{W}{t}$	W (watt)	Wh = 3 600 J (watthour)	1 N.m = 1 W.s = 1 J 1 kgm = 9.81 J (calorie) 1 cal = 4.18 J 1 kgm = 1.055 J (British thermal unit) 1 ch = 736 W 1 HP = 746 W
Volumetric flow	Débit volumique	q_v	$q_v = \frac{dV}{dt}$	m ³ /s		
Efficiency	Rendement	η		< 1		%
Dynamic viscosity	Viscosité dynamique	η, μ		Pa.s		poise, 1 P = 0.1 Pa.s
Kinematic viscosity	Viscosité cinématique	ν	$\nu = \frac{\eta}{\rho}$	m ² /s		stokes, 1 St = 10 ⁻⁴ m ² /s

IMfinity® 3-phase induction motors - IE2 - IE3 - IE4 - Non IE Efficiency

Appendix

Unit conversions

Unit	MKSA (International System)	AGMA (US system)
Length	1 m = 3,280 8 ft 1 mm = 0,0393 7 in	1 ft = 0.304 8 m 1 in = 25.4 mm
Weight	1 kg = 2.204 6 lb	1 lb = 0.453 6 kg
Torque	1 Nm = 0.737 6 lb.ft 1 N.m = 141.6 oz.in	1 lb.ft = 1.356 N.m 1 oz.in = 0.007 06 N.m
Force	1 N = 0.224 8 lb	1 lb = 4.448 N
Moment of inertia	1 kg.m ² = 23.73 lb.ft ²	1 lb.ft ² = 0.042 14 kg.m ²
Power	1 kW = 1.341 HP	1 HP = 0.746 kW
Pressure	1 kPa = 0.145 05 psi	1 psi = 6.894 kPa
Magnetic flux	1 T = 1 Wb / m ² = 6.452 10 ⁴ line / in ²	1 line / in ² = 1.550 10 ⁻⁵ Wb / m ²
Magnetic losses	1 W / kg = 0.453 6 W / lb	1 W / lb = 2.204 W / kg

Multiples and sub-multiples		
Factor by which the unit is multiplied	Prefix to be placed before the unit name	Symbol to be placed before that of the unit
10 ¹⁸ or 1 000 000 000 000 000 000	exa	E
10 ¹⁵ or 1 000 000 000 000 000	peta	P
10 ¹² or 1 000 000 000 000	tera	T
10 ⁹ or 1 000 000 000	giga	G
10 ⁶ or 1 000 000	mega	M
10 ³ or 1 000	kilo	k
10 ² or 100	hecto	h
10 ¹ or 10	deca	da
10 ⁻¹ or 0.1	deci	d
10 ⁻² or 0.01	centi	c
10 ⁻³ or 0.001	milli	m
10 ⁻⁶ or 0.000 001	micro	μ
10 ⁻⁹ or 0.000 000,001	nano	n
10 ⁻¹² or 0.000 000,000,001	pico	p
10 ⁻¹⁵ or 0.000 000,000,000,001	femto	f
10 ⁻¹⁸ or 0.000 000,000,000,000,001	atto	a

IMfinity® 3-phase induction motors - IE2 - IE3 - IE4 - Non IE Efficiency

Appendix

Standard formulae used in electrical engineering

MECHANICAL FORMULAE

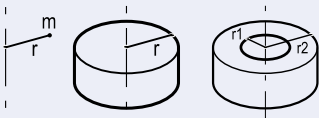
Title	Formula	Unit	Definitions / Notes
Force	$F = m \cdot \gamma$	F in N m in kg γ in m/s ²	A force F is the product of a mass m by an acceleration γ
Weight	$G = m \cdot g$	G in N m in kg $g = 9.81$ m/s ²	
Torque	$M = F \cdot r$	M in N.m F in N r in m	The torque M of a force in relation to an axis is the product of that force multiplied by the distance r of the point of application of F in relation to the axis.
Power	- rotating $P = M \cdot \omega$ - linear $P = F \cdot V$	P in W M in N.m ω in rad/s P in W F in N V in m/s	Power P is the quantity of work yielded per unit of time $\omega = 2\pi N/60$ where N is the speed of rotation in min ⁻¹ $V =$ linear velocity
Acceleration time	$t = J \cdot \frac{\omega}{M_a}$	t in s J in kg.m ² ω in rad/s M_a in Nm	J is the moment of inertia of the system M_a is the moment of acceleration Note: All the calculations refer to a single rotational speed ω , where the inertias at speed ω' are corrected to speed ω by the following calculation: $J_\omega = J_{\omega'} \cdot \left(\frac{\omega'}{\omega}\right)^2$
Moment of inertia Centre of gravity	$J = m \cdot r^2$		
Solid cylinder around its axis	$J = m \cdot \frac{r^2}{2}$	J in kg.m ² m in kg r in m	
Hollow cylinder around its axis	$J = m \cdot \frac{r_1^2 + r_2^2}{2}$		
Inertia of a mass in linear motion	$J = m \cdot \left(\frac{V}{\omega}\right)^2$	J in kg.m ² m in kg v in m/s ω in rad/s	The moment of inertia of a mass in linear motion transformed to a rotating motion.

IMfinity® 3-phase induction motors - IE2 - IE3 - IE4 - Non IE Efficiency

Appendix

Standard formulae used in electrical engineering

ELECTRICAL FORMULAE

Title	Formula	Unit	Definitions / Notes
Accelerating torque	$M_a = \frac{M_d + 2M_a + 2M_m + M_n - M_r}{6}$ <p>General formula:</p> $M_a = \frac{1}{N_n} \int_0^{N_n} (M_{mot} - M_r) dN$	Nm	Moment of acceleration M_a is the difference between the motor torque M_{mot} (estimated), and the resistive torque M_r . (M_d , M_a , M_m , M_n , see curve below) N = instantaneous speed N_n = rated speed
Power required by the machine	$P = \frac{M \cdot \omega}{\eta_a}$	P in W M in N.m ω in rad/s η_A without unit	η_a expresses the efficiency of the driven machine. M is the torque required by the driven machine.
Power drawn by the 3-phase motor	$P = \sqrt{3} \cdot U \cdot I \cdot \cos \varphi$	P in W U in V I in A	φ phase angle by which the current lags or leads the voltage. U armature voltage. I line current.
Reactive power drawn by the motor	$Q = \sqrt{3} \cdot U \cdot I \cdot \sin \varphi$	Q in VAR	
Reactive power supplied by a bank of capacitors	$Q = \sqrt{3} \cdot U^2 \cdot C \cdot \omega$	U in V C in μ F ω in rad/s	U = voltage at the capacitor terminals C = capacitor capacitance ω = rotational frequency of supply phases ($\omega = 2\pi f$)
Apparent power	$S = \sqrt{3} \cdot U \cdot I$ $S = \sqrt{P^2 + Q^2}$	S in VA	
Power supplied by the 3-phase motor	$P = \sqrt{3} \cdot U \cdot I \cdot \cos \varphi \cdot \eta$		η expresses motor efficiency at the point of operation under consideration.
Slip	$g = \frac{N_s - N}{N_s}$		Slip is the difference between the actual motor speed N and the synchronous speed N_s
Synchronous speed	$N_s = \frac{120 \cdot f}{p}$	N_s in min^{-1} f in Hz	p = number of poles f = frequency of the power supply

Parameters	Symbol	Unit	Torque and current curve as a function of speed
Starting current	I_d	A	
Rated current	I_n		
No-load current	I_o		
Starting torque*	M_d	Nm	
Run up torque	M_a		
Breakdown torque	M_m		
Rated torque	M_n		
Rated speed	N_n	min^{-1}	
Synchronous speed	N_s		

* Torque is the usual term for expressing the moment of a force.

IMfinity® 3-phase induction motors - IE2 - IE3 - IE4 - Non IE Efficiency

Appendix

Tolerance on main performance parameters

TOLERANCES OF ELECTROMECHANICAL CHARACTERISTICS

IEC 60034-1 specifies standard tolerances for electromechanical characteristics.

Parameters	Tolerances
Efficiency $\left\{ \begin{array}{l} \text{machines } P \leq 150 \text{ kW} \\ \text{machines } P > 150 \text{ kW} \end{array} \right.$	$- 15 \% \text{ of } (1 - \eta)$ $- 10 \% \text{ of } (1 - \eta)$
$\cos \varphi$	$- 1/6 (1 - \cos \varphi)$ (min 0.02 - max 0.07)
Slip $\left\{ \begin{array}{l} \text{machines } P < 1 \text{ kW} \\ \text{machines } P \geq 1 \text{ kW} \end{array} \right.$	$\pm 30 \%$ $\pm 20 \%$
Locked rotor torque	$- 15 \%, + 25 \% \text{ of rated torque}$
Starting current	$+ 20 \%$
Run-up torque	$- 15 \% \text{ of rated torque}$
Maximum torque	$- 10 \% \text{ of rated torque}$ $> 1.5 M_N$
Moment of inertia	$\pm 10 \%$
Noise	$+ 3 \text{ dB (A)}$
Vibration	$+ 10 \% \text{ of the guaranteed class}$

Note: IEC 60034-1 - does not specify tolerances for current
- the tolerance is $\pm 10\%$ in NEMA-MG1

TOLERANCES AND ADJUSTMENTS

The standard tolerances shown below are applicable to the drawing dimensions given in our catalogues. They comply fully with the requirements of IEC standard 60072-1.

Characteristics	Tolerances
frame size $H \leq 250$ ≥ 280	$0, - 0.5 \text{ mm}$ $0, - 1 \text{ mm}$
Diameter \varnothing of the shaft extension: - 11 to 28 mm - 32 to 48 mm - 55 mm and over	j6 k6 m6
Diameter N of flange spigots	j6 up to FF 500, js6 for FF 600 and more
Key width	h9
Width of drive shaft keyway (normal keying)	N9
Key depth: - square section - rectangular section	h9 h11
① Eccentricity of shaft in flanged motors (standard class) - diameter > 10 up to 18 mm - diameter > 18 up to 30 mm - diameter > 30 up to 50 mm - diameter > 50 up to 80 mm - diameter > 80 up to 120 mm	0.035 mm 0.040 mm 0.050 mm 0.060 mm 0.070 mm
② Concentricity of spigot diameter and ③ perpendicularity of mating surface of flange in relation to shaft (standard class) Flange (FF) or Faceplate (FT): - F 55 to F 115 - F 130 to F 265 - F 300 to F 500 - F 600 to F 740 - F 940 to F 1080	0.08 mm 0.10 mm 0.125 mm 0.16 mm 0.20 mm

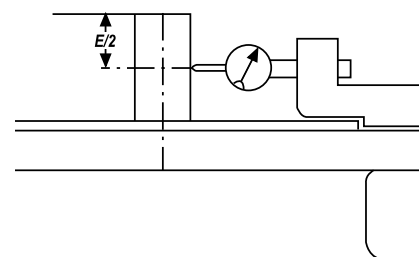

① Eccentricity of shaft in flanged motors

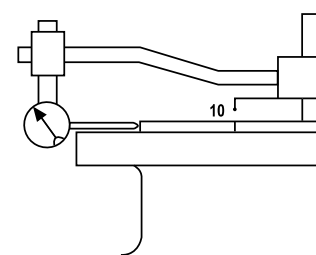

② Concentricity of spigot diameter

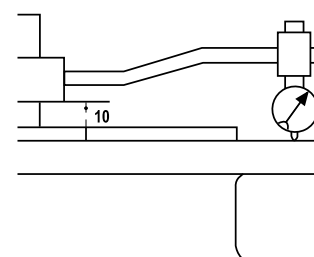

③ Perpendicularity of mating surface of flange in relation to shaft

IMfinity® 3-phase induction motors - IE2 - IE3 - IE4 - Non IE Efficiency

Appendix

Declaration of CE conformance

 EMERSON Industrial Automation	PS4 : INSPECTION, MEASURING & TEST EQUIPMENT MANAGEMENT	Classement / File : S4T007	
	EU DECLARATION OF CONFORMITY AND INCORPORATION		Révision : D Date : 06/04/2016
Annule et remplace / Cancels and replaces : S4T007 Révision C du 06/12/2012			<input type="checkbox"/> M <input checked="" type="checkbox"/> R <input type="checkbox"/> I GP, Mansle & IMI

We, **MOTEURS LEROY SOMER**, boulevard Marcellin Leroy 16915 ANGOULEME cedex 9, France, declare, under our sole responsibility that the following products:

(F)LS, PLS, (F)LSHT (F)LSES*, PLSES*, LSMV* induction motor

comply with:

- European Directives :
 - Low Voltage Directive: **2014/35/EU**
 - Electromagnetic Compatibility Directive **2014/30/EU**
 - ErP Directive **2009/125/EC** and regulation (EC) application : **640/2009** and corrections (valid only for products marked with an asterisk*)
- European and International standards : **IEC-EN 60034-1:2010; 60034-2-1:2014; 60034-5:2001/A1:2007; 60034-6:1993 ; 60034-7:1993/A1:2001; 60034-8:2007/A1:2014; 60034-9:2005/A1:2007; 60034-14:2004 /A1:2007; 60034-30-1:2014 ; 60072-1:1991**

This conformity permits the use of these ranges of products in machines subject to the application of the Machinery Directive 2006/42/EC, provided that they are integrated or incorporated and/or assembled in accordance with, amongst others, the regulations of standard EN 60204 "Electrical Equipment for Machinery".

The products defined above may not be put into service until the machines in which they are incorporated have been declared as complying with the applicable Directive.

Installation of these motors must comply with the regulations, decrees, laws, orders, directives, application circulars, standards, rules or any other document relating to the installation site. LEROY-SOMER accepts no liability in the event of failure to comply with these rules and regulations.

Note: When the motors are supplied via appropriate electronic inverters and/or controlled by electronic control or monitoring devices, they must be installed by a professional who will be responsible for ensuring that the electromagnetic compatibility regulations of the country in which the product is installed are observed.

Date and Signature of technical director :

Eric VASSENT

The 08th April 2016



Leroy-Somer Consulter le système de gestion documentaire afin de vérifier la dernière version de ce document
 For the latest version of this document, please access the document management system

Leroy-Somer™

www.emersonindustrial.com/automation

Connect with us at:

twitter.com/Leroy_Somer

facebook: <http://lrsm.co/fb>

youtube.com/user/LeroySomerOfficiel

theautomationengineer.com (blog)



Moteurs Leroy-Somer SAS. Headquarters: Bd Marcellin Leroy, CS 10015, 16915 Angoulême Cedex 9, France.
Share Capital: € 65 800 512, RCS Angoulême 338 567 258.