

CHEETAH SM USER GUIDE

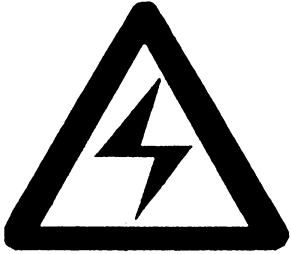

0421-0003-03



HEALTH AND SAFETY AT WORK

The voltage present in this controller drive module are capable of inflicting a severe electric shock, and may be lethal. It is the responsibility of the owner or user to ensure that the installation of this controller and the way on which it is operated and maintained complies with the requirements of applicable legislation and/or regulations.

Only qualified personnel should install this equipment, after first reading and understanding the information in this Guide. The installation instructions should be adhered to. Any question or doubts should be referred to the supplier of the equipment.

The contents of this guide are believed to be correct at the time of printing. In the interests of the commitment to a policy of continuous development and improvement, the manufacturer reserves the right to change the specification of the product or its performance or the contents of the User's Guide without notice.

The manufacturer accepts no liability for any consequences resulting from inappropriate, negligent or incorrect installation or adjustment of the optional operating parameters of the equipment, or from mismatching of the controller to the motor and drive load.

All right reserved. No part of this book may be reproduced or transmitted in any form or by any means, electronic or mechanical including photocopying, recording, or by any information storage or retrieval system without permission from the publisher in writing.

Copyright 1993 Control Techniques plc.

ISSUE 3
Part No: 0421-0003-03



CONTROL TECHNIQUES DRIVES LTD
79 MOCHDRE INDUSTRIAL ESTATE
NEWTOWN, POWYS SY16 4LE

DECLARATION OF CONFORMITY

The DC variable speed drive product Cheetah SM, enclosed and module versions, has been designed and manufactured in accordance with the following European harmonised, national and international standards:

EN60249	Base materials for printed circuits
IEC326-1	Printed boards: General information for the specification writer
IEC326-5	Printed boards: Specification for single and double sided printed boards with plated through holes
IEC326-6	Printed boards: Specification for multilayer printed boards
IEC664-1	Insulation co-ordination for equipment within low-voltage systems: Principles, requirements and tests
EN60529	Degrees of protection provided by enclosures (IP code)
UL94	Flammability rating of plastic materials
C22.2 No. 14-M91	CSA Standard for Industrial Control Equipment

This product complies with the Low Voltage Directive 73/23/EEC and the CE Marking Directive 93/68/EEC.

W. Drury
Technical Director

Newtown
Date: 26th September 1996

Note

This electronic drive product is intended to be used with an appropriate motor, controller, electrical protection components and other equipment to form a complete end product or system. It must only be installed by a professional assembler who is familiar with requirements for safety and electromagnetic compatibility ("EMC"). The assembler is responsible for ensuring that the end product or system complies with all the relevant laws in the country where it is to be used. Refer to the product manual or EMC data sheet for further information on EMC standards complied with by the product, and guidelines for installation.

K. Wong
17/9/96



0115-0009

Rev.0
Issue A

CHEETAH SM

1.5KW DC THYRISTOR CONTROLLER

INTRODUCTION

The Cheetah SM series of DC Motor Controller is designed for the efficient speed control of both wound field and permanent magnet DC motors up to 1.5KW rating. Supply voltage is 220/240 or 110/120V, 50-60 Hz single phase supply operation.

- Non isolated unidirectional, non braking controller as standard
- Available as chassis mounted module (IP00) or enclosed module for wall mounting (IP40)
- Screw terminal connections for input and output
- 20 : 1 constant torque – speed range
- 2% regulation for 100% load change with armature voltage feedback (AVF), 0.5% regulation with tacho feedback
- Fusing and electronic current limit protection
- Surface mount technology

SPECIFICATION

MOTOR KW (Typical) (220/240V Supply)	MOTOR HP (Typical)	MAXIMUM CONTINUOUS AVERAGE OUTPUT CURRENT AMPS	DISSIPATION WATTS LOST (Approx)	INPUT LINE CURRENT AMPS RMS
1.5	2	11	32	16

Table 1.

MOTOR VOLTAGE DC	ARMATURE VOLTAGE	FIELD VOLTAGE
110/120V AC Supply	90V	95V
220/240V AC Supply	180V	190/210V

Table 2.

SUPPLY VOLTAGE

220/240V or 110/120V AC +/-10% 50/60Hz single phase. Link selectable. (LK1)

OUTPUT VOLTAGE

0-180V DC Armature, 190/210V Field
0-90V DC Armature, 95V Field

OVERLOAD

150% of continuous current for 15 seconds – trip action

OPERATING TEMPERATURE

Ambient -10 Deg C to +40 Deg C

HUMIDITY

5-95% RH at 40 Deg C. Non condensing

ALTITUDE

Above 1000m derate by 1%/100metres to 4000 metres max

CONTROL METHOD

Full wave bridge – half controlled - phase angle

MECHANICAL

Dimensions: Chassis module: 188W x 150H x 65D (mm)
Enclosed module: 259W x 195H x 60D (mm)

FAULT FINDING

FAULT	POSSIBLE CAUSE	ACTION
Motor does not run at initial switch on.	Fuse FS1 open cct LED1 does not light	Check all field circuits for shorts and earths
	No speed reference	Check voltage on terminal 3
	Stop/run input terminal 5 & 7 not closed LED 2 OVERLOAD is lit	Check control circuit Check correct presence of all selector links Check motor armature circuit for shorts and earth faults
Motor runs for a while and stops LED2 OVERLOAD lights	Incorrect current limit setting	Check and adjust RV5 Check SW1.3, 1.4
	Motor overload	Check armature current is within motor rating
	Field circuit fault	Check motor field voltage and current
Motor runs up to max speed and stops LED2 lights	Wrong tacho feedback voltage	Decrease max speed pot RV1 check SW1.3, 1.4 setting
	Switch SW1.8 incorrect	Set, On = AVF
	Faulty tacho Sw1.6, 1.7 set for incorrect motor voltage	Check voltage terminal 8 & 9 Check
Motor runs at full speed only	Open circuit speed control pot	Check voltage at terminal 3 varies between 0 & 10V approx
	Min, Speed pot set too high	Reduce
Drive unstable	Incorrect setting of stability pot	Adjust RV6 for optimum stability
	Too much IR compensation	Adjust RV4 anticlockwise

4 - 20mA SPEED REFERENCE INPUT

A 4 - 20mA speed control loop can be used to control motor speed, instead of either the speed pot or 0 - 10V signal. Connections should be made as shown in figure 7. The input is via the minimum speed terminal so, the minimum speed preset potentiometer must be set fully clockwise. Link LK4 and LK5 must be set in position A. When using 4 - 20mA input no voltage must be present on terminal 3.

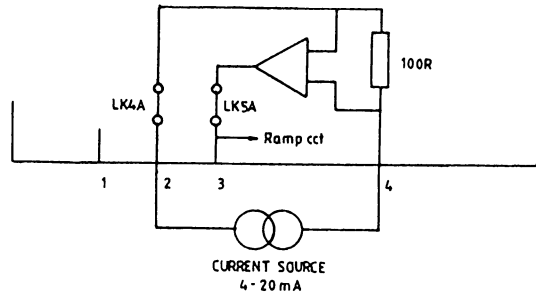

Fig. 7.

OPEN COLLECTOR OUTPUTS

There are two open collector outputs available, which can be used for indication of Drive tripped and Low speed. Connection arrangements for use with a relay are shown in fig 8. The relay is energised when the drive is not tripped (P4), or at low speed (P3).

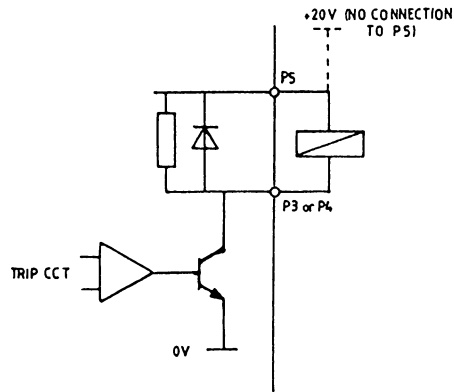

Fig. 8.

CONTROL INPUTS - NON ISOLATED

- Set Speed**
Terminal 3
Potentiometer 10K minimum or 0 to +10V, input impedance 100K ohm filtered.

Or 4 - 20mA, 100 ohm impedance by jumper link select (LK4 and 5) via terminal 2. See page 14.
- Run Inhibit**
Terminal 7
N/O contact, closed to run, or open collector 0 to +10V logic signal at 5mA.
- Tacho Input**
Terminals 8 and 9
Selected by DIL switch. DC voltage input non polarity conscious. Four different tacho scalings selected by DIL switch: 0 - 15V, 0 - 30V, 0 - 60V, 0 - 120V. Voltage inputs are absolute maximums at maximum motor speed.
- Set Torque**
Terminal 6
Potentiometer 10K minimum or 0V to +10V, input impedance 100K ohm. Selected by DIL switch. 10V in gives 100% torque, depending on scaling.

CONTROL OUTPUTS - NON ISOLATED

- Analogue Reference**
Terminal 1
+10V reference at 5mA for potentiometer input.
- Speed Indication**
P1
0 to +10V at 5mA = 0 to maximum speed, depending on scaling. Accuracy = $\pm 5\%$ (AVF, motoring), $\pm 2\%$ (tacho feedback) (via wire solder pad).
- Unregulated DC Supply**
P5
22V ($\pm 20\%$) at 10mA for external use. eg. relay or indicator.
- Low Speed Indication***
P3
Open collector output, maximum pull up voltage is +24V, maximum sink current is 50mA.

Logic High = Motor above 1% of rated speed.

Logic Low = Motor below 1% of rated speed (via wire solder pad).
- Zero Speed Indication***
P3
Open collector output, maximum pull up voltage is +24V, maximum sink current is 50mA.

Logic High = Speed reference greater than 1% of set speed.
 Logic Low = Speed reference less than 1% of set speed (via wire solder pad).

* Either low speed indication or zero reference indication may be jumper link selected. (LK6)

Status / Fault Indication P4
 Open collector output, maximum pull up voltage is +24V, maximum sink current is 50mA.
 Logic High = Drive in fault (tripped) or power off condition.
 Logic Low = Drive not tripped.

Load (Torque) Indication P2
 0 to +10V at 5mA = 0 to 150% FLT accuracy = $\pm 5\%$ (matched motor).

Ramp Output P6
 0 to +10V at 5mA = minimum speed potentiometer setting to maximum set speed.

CONTROL OUTPUTS - ISOLATED

A volt free change over relay, contacts rated at 240V, 3A AC resistive can be selected to indicate:

Low Speed T10, 11, & 12
 Changes over (relay de-energised) if motor above 1% of rated speed.

or Zero Speed
 Changes over (relay de-energised) if speed reference above 1% of rated speed.

or Status/Fault
 Changes over (relay de-energised) power loss or trip.

ADJUSTMENTS BY INDIVIDUAL POTENTIOMETERS

Maximum Speed RV1
 Approx 100% to 50% of maximum motor speed. May be pre-scaled by DIL switch.

Minimum Speed RV2
 Approx 0 to 50% of maximum preset motor speed.

Ramp Up RV3B
 Approx 0.5 seconds to 15 seconds, linear.

Ramp Down RV3A
 Approx 0.5 seconds to 15 seconds, linear.

TACHO FEEDBACK

Connect the tacho wires to terminals 8 and 9. Switch SW1 .8 must be set to Off. The tacho may be either AC or DC but DC types are preferred. The input to the feedback circuit is via a full-wave rectifier and therefore tacho polarity insensitive. The scaling of the tacho input is important and must be scaled using DIL switches SW1 .6 and 1 .7

Tacho feedback max volts (not V/1000rpm rating)	Switch setting SW1 .6 SW1 .7	
15	1	1
30	1	0
60	0	1
120	0	0

With tacho feedback, the maximum speed pot must, during commission, be turned fully anti-clockwise before switching on, and then adjusted during commission. Failure to do this may cause the motor to overspeed and the controller to cutout. Ensure IR Comp pot is set to minimum.

TORQUE CONTROL

The armature current (torque) can be controlled with an external potentiometer as shown in figure 6. When the pot is turned fully anti-clockwise the wiper should be at zero volts. Clockwise rotation of the torque pot will then give control of the armature current from zero to current selection by switches SW1 .3 and 1 .4. Even though the drive is running continuously in current limit the drive will not trip as the Ixt trip is disabled. If not required, the speed potentiometer should be replaced by a wire link between terminals 1 and 3.

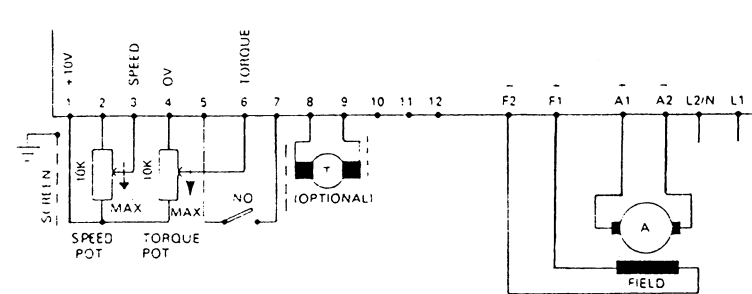

Fig 6.

POTENTIOMETER DESCRIPTIONS

RV1 MAXIMUM SPEED

RV1 is used to set the maximum output voltage. With maximum speed demand input adjust RV1 to give required motor speed. Clockwise rotation increases motor speed. Ensure maximum motor voltage is not exceeded.

RV2 MINIMUM SPEED

RV2 sets the minimum speed of the motor when zero speed reference is applied. Clockwise rotation increases motor speed.

RV3B} RAMP CONTROLS RV3A}

These two controls are used to set the acceleration and deceleration respectively. Normal ramp characteristic is linear with a .5-15 second range, although the motor may take longer to accelerate under current limit. Clockwise rotation increase ramp time.

RV4 IR COMPENSATION

IR Compensation improves the regulation of the drive when in AVF mode. To set, the speed of the drive must be checked on no load and full load and the IR Comp pot adjusted to give minimum speed drop. Turning the potentiometer too far clockwise may cause instability. With Tacho feedback the IR comp pot should be set fully anti-clockwise.

RV5 CURRENT LIMIT AND OVERLOAD

RV5 is used to set the maximum output current to approx 150% of the motors rated current. Approximate maximum continuous output current for each range are listed in the switch functions section (SW1 .3 and 1 .4). It is important to ensure that the available current is not too great for the motor. The overload threshold is approximately 110% of the adjusted output, a 150% overload giving an approximate 15 second trip time. Clockwise rotation of RV5 increases the available current. Reducing the level of RV5 also reduces the threshold of the overload trip system. To reset after a trip, remove mains supply for 1-2 seconds.

RV6 STABILITY

RV6 is used to set the response of the drive. It should be adjusted clockwise to improve the stability or anti-clockwise to improve the response. Too fast a response will cause the system to hunt.

IR Compensation RV4	Optimises speed regulation against load change.
Current Limit RV5	Approx 0 to 100% of rated output current. May be pre-scaled to 40%, 50% and 75% by DIL switch.
Stability RV6	Optimises system stability.

ADJUSTMENTS BY CONTROL LINKS / DIL SWITCHES

Set Speed: 0 to +10V / 4-20mA	Jumper Link LK4,5
Speed/Torque Control	DIL Switch Sw1.5
Tacho/AVF Feedback	DIL Switch Sw1.8
AVF Scaling (4 values: 25, 50, 100 & 200V) Tacho Scaling (4 values: 15, 30, 60, & 120V)	DIL Switch Sw1.6,7
Low Speed/Zero Reference	Jumper Link LK6
Relay to indicate Status/Fault or Low Speed/ Zero Reference	DIL Switch Sw1.1,2
Current Feedback Scaling (4 values: 40, 50, 75 and 100% of FLC)	DIL Switch Sw1.3,4
Input Supply Voltage 110/120 or 220/240V	Power Link LK1

PROTECTION

Fast HRC AC supply input fuse, 15 amp ceramic
AC supply filter and transient suppression
Field varistor fitted
Adjustable electronic current limit with timed overload
Instantaneous over current trip
Fused against control earth faults

DIAGNOSTICS

LED indication of	Power On Overload lxt/Peak Current Standby/Reset
-------------------	--

Fault indication by RELAY or open collector output.

ELECTRICAL

Note: Ensure the controller is disconnected from the supply before working on the unit.

POWER CABLING

Only use cable with correct voltage and current ratings. A minimum of 600V AC rating is recommended. Input and output currents are listed in table 1.

CONTROL SIGNAL CABLING

For use with the controller, requires a similar voltage specification, and must be carefully routed to avoid any power cabling from the drive or any other equipment. When installed run/inhibit or speed-reference cable lengths are greater than approx. 10 metres please consult your supplier.

INPUT FUSING

The line input to controller is fused using HRC 15 Amp fuse. A glass type must NOT be used. If panel fuses are to be fitted a suitable rating is 20 amp at 240 volts. Fusing the motor supply is not recommended.

SELECTOR LINKS AND SWITCHES

Must be repositioned with the controller switched off and disconnected for safety. Factory settings are listed in table 3.

Although the controller is very well protected and incorporates a high degree of electrical noise immunity, installations involving electrical welding, RF induction heating etc., may benefit from the addition of a simple mains filter on the AC supply. Please consult your supplier.

MOTOR CHOKES

When specified for certain DC motors, must be wired in series with the motor armature.

LINK SELECTION

LK1 MAINS SUPPLY SELECTION

LK1 allows mains transformer adjustment to either a 110/120 or 220/240 volt 2 wire supply. SW1.6 and 1.7 should also be checked to ensure motor voltage compatibility.

LK2 } LOW VOLTAGE DC TACHOMETER

LK3 } Consult supplier

LK4 } 4-20mA SPEED REFERENCE INPUT

LK5 }

LK4 and 5 when in position A allow use of a 4-20mA current loop input. Note that when a 4-20 input is used that the minimum speed preset potentiometer must be turned fully clockwise and the voltage input on terminal 3 should be removed. See page 14.

LK6 LOWSPEED OR LOW SPEED DEMAND

LK6 selects the function of the low speed detection circuit. When in position "A" the motor speed is monitored, (either armature or tacho voltage). If LK6 is fitted in the unmarked position then the reference signal is monitored, (0-10V or 4-20mA).

WIRE PAD FACILITIES

P1 Speed indication

P2 Load indication

P3 Low speed indication

P4 Trip indication

P5 22V 10mA unregulated DC output

P6 Ramp output indication

SW1.5 TORQUE CONTROL

Either speed or torque control can be selected using SW1.5. When in the off position speed control is enabled, torque control is selected in the on position.

SW1.6 } FEEDBACK VOLTAGE SCALING SW1.7 }

SW1.6 and 1.7 are used for both armature and tacho feedback scaling.

When the drive is used in AVF control there are four maximum motor speed selections.

0 = Switch Off 1 = Switch On

SW1.6	SW1.7	Max Volts
0	0	200
0	1	100
1	0	50
1	1	25

When the drive is in Tacho feedback the switches select the full scale tacho voltage (not V/1000 rpm) up to a maximum of 120V.

0 = Switch Off 1 = Switch On

SW1.6	SW1.7	Max volts
0	0	120
0	1	60
1	0	30
1	1	15

Note that these values are intended for use when the motor voltage is matched to the highest range of the drive eg. 180V.

SW1.8 AVF / TACHO FEEDBACK

Tacho feedback can be used for more accurate speed control (refer to specification page 1). Either armature voltage or tacho feedback can be selected using SW1.8. With the switch off tacho feedback is selected, AVF is selected when on.

LINK AND SWITCH FACTORY SETTING

LK1	Mains supply 240V
LK2/3	Not fitted
LK4/5	Speed reference 0-10V
LK6	Low speed indication
SW1.1	Low speed relay off
SW1.2	Status relay off
SW1.3 SW1.4	Current limit scaling 100%
SW1.5	Speed control
SW1.6 SW1.7	Set for 180V armature (by RV1)
SW1.8	Armature voltage feedback

Table 3.

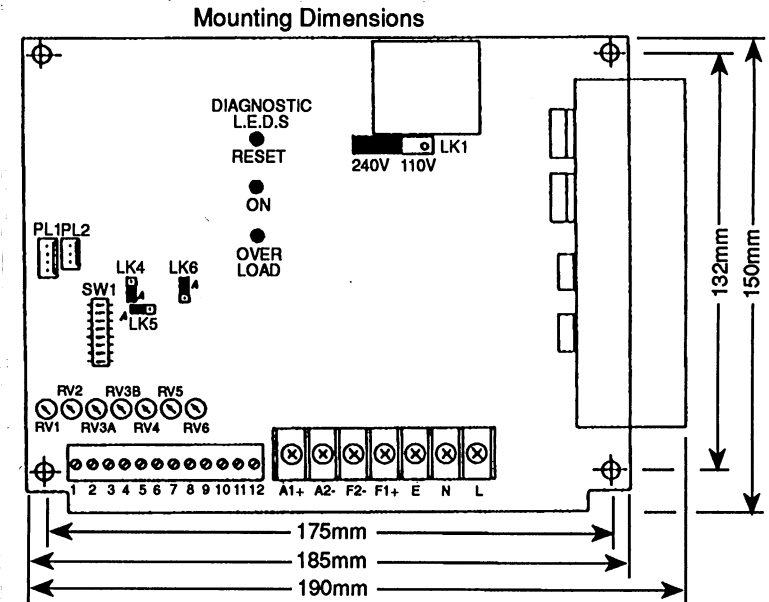

CHEETAH SM LAYOUT
Fig. 1.

SWITCHING ON

A basic set up is shown below. Check for correct setting of Links and Switches, (refer to factory settings listed in table 3. Turn the speed potentiometer for zero demand. Switch on the mains supply. The ON LED will light. Terminals 5 and 7 must then be switched together to obtain the run condition. Slowly increase the speed demand and observe the motor direction of rotation. If incorrect, switch off the mains supply and reverse the armature connections. Restart the drive and check operation of all functions.

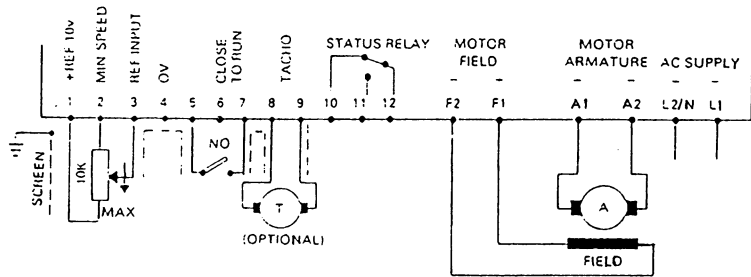

Fig 2.

AUTO / MANUAL START

As supplied the drive will power up in auto start mode ie. ready to run. Manual start can be selected by connection to PL1, see figure 3 below. When manual start is selected the drive will power up in a standby mode with its Reset LED lit. The drive can be made to run by momentarily closing pins 3 and 4 on plug PL1. Any interruption in line supply will leave the drive in standby mode again.

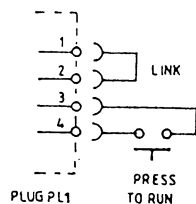

Fig 3.

CONTROL SELECTIONS

SWITCH FUNCTION

SW1.1} STATUS RELAY SELECTION SW1.2}

SW1.1 When "ON" the status relay indicates "low speed" or "low speed demand", depending on the position of link LK6. The relay is energised at low speed and de-energised when speed increases. When the speed is increasing the relay changes state at 1.5% of selected speed range (SW1.6 and SW1.7), and when decreasing at 1%.



Fig 4.

Low speed

High speed / Drive Off

SW1.2 When "ON" the status relay indicates a trip condition. The relay is energised under healthy conditions and de-energised during trip or power down condition.



Fig 5.

Healthy

Trip / Drive Off

SW1.3 } CURRENT LIMIT SCALING SW1.4 }

Sw1.3 and 1.4 are used jointly to select 1 of 4 maximum current limits.

0 = Switch Off

1 = Switch On

SW1.3	SW1.4	% FLC	AMPS
0	0	100	11
1	0	75	8
0	1	50	5.5
1	1	40	4.5

Note that RV5, current limit preset potentiometer, functions on each range.